

ENGLISH

**APW-895/IP-420
INSTRUCTION MANUAL**

* "CompactFlash(TM)" is the registered trademark of SanDisk Corporation, U.S.A.

CONTENTS

I. CAUTIONS BEFORE OPERATION.....	1
II. CONFIGURATION OF THE MACHINE	2
III. SPECIFICATIONS.....	3
1. MECHANICAL SPECIFICATIONS.....	3
2. ELECTRICAL SPECIFICATIONS	3
IV. INSTALLATION.....	4
1. REMOVING PACKING MATERIALS	4
2. SECURING THE MACHINE.....	4
3. CONNECTING THE FOOT PEDAL	5
4. CONNECTING THE AIR COUPLER	5
5. CONNECTING THE POWER PLUG	6
6. ASSEMBLING THE THREAD STAND AND ATTACHING IT TO THE MACHINE	7
7. INSTALLING SP-46 (CLAMP BAR STACKER) (OPTIONAL PART NO. : 40058952)	7
8. INSTALLING SP-47 (ROLLER STACKER) (OPTIONAL PART NO. : 40058953)	8
9. REMOVING THE HEAD FIXING PLATE	9
10. INSTALLING THE SUB-TABLE	9
11. INSTALLING OPERATION PANEL IP-420.....	9
12. LUBRICATING THE OIL TANK	10
13. INSTALLING SA-120 (INTERLINING SUPPLYING DEVICE) (OPTIONAL PART NO. : 40045772)....	11
14. ADJUSTMENT OF SA-120 (INTERLINING SUPPLYING DEVICE) (OPTIONAL PART NO. : 40045772)	12
V. PREPARATION OF THE SEWING MACHINE	13
1. HOW TO OPERATE THE SEWING MACHINE HEAD	13
(1) How to attach the needles	13
(2) Thread used.....	13
(3) How to pass the needle thread	14
2. HOW TO REMOVE THE SEWING TABLE.....	15
(1) When replacing the bobbin thread.....	15
(2) Cautions to be taken when the sewing tables are removed	16
3. HOW TO WIND THE BOBBINS.....	17
4. HOW TO THREAD THE BOBBIN CASE.....	18
5. HOW TO INSTALL THE BOBBIN CASE.....	18
6. HOW TO ADJUST THE THREAD TENSION.....	19
7. SETTING THE MATERIAL TO BE SEWN	20
(1) Setting a garment body	20
8. ADJUSTING THE MATERIAL GUIDE	20
VI. HOW TO USE THE OPERATION PANEL.....	21
1. PREFACE.....	21
2. BASIC OPERATION OF THE OPERATION PANEL (IP-420)	24
(1) Configuration of IP-420	24
(2) Buttons used in common	25
(3) Basic operation	25
3. EXPLANATION OF THE BASIC SCREEN.....	28
(1) Input screen (Independent sewing mode).....	28
(2) Sewing screen (Independent sewing mode)	29

(3) Input screen (Alternate sewing mode)	30
(4) Sewing screen (Alternate sewing mode)	31
(5) Input screen (Cycle sewing mode).....	32
(6) Sewing screen (Cycle sewing mode)	33
4. USING THE COUNTER	34
(1) Setting procedure of the counter.....	34
(2) Releasing procedure of count-up.....	37
(3) Counter value changing procedure during sewing	37
5. USING THE BOBBIN THREAD AMOUNT ADJUSTMENT COUNTER	38
(1) Setting procedure of the bobbin thread remaining amount adjustment counter	38
(2) Releasing procedure of the bobbin thread remaining amount detection count-up	40
6. CHANGING THE SEWING MODE.....	41
7. USING THE SEWING PATTERN	42
(1) Performing the selection of pattern.....	42
(2) Performing the new creation of pattern.....	43
(3) Copying the pattern.....	44
(4) Erasing the pattern.....	46
(5) Naming the pattern	47
(6) Editing procedure of the cycle sewing data	48
8. CHANGING THE SEWING DATA.....	50
(1) Changing procedure of the sewing data	50
(2) Sewing data list.....	51
9. CHANGING THE MEMORY SWITCH DATA	59
(1) Changing procedure of the memory switch data	59
(2) Memory switch data list.....	60
10. PERFORMING OPTIONAL SETTING	68
(1) Changing procedure of the optional setting	68
(2) Optional setting list.....	69
11. CHANGING THE DEVICE SETTING	70
(1) Changing procedure of the device setting	70
(2) Device setting list.....	71
12. CUSTOMIZING THE PEDAL OPERATION	72
(1) Method to select and use the customized data.....	72
(2) Customizing the pedal operation data	73
13. CUSTOMIZING THE DATA INPUT SCREEN	75
(1) Customizing procedure	75
14. PERFORMING THE CUSTOMIZING SETTING OF THE SEWING SCREEN	77
(1) Customizing procedure	77
15. USING THE INFORMATION.....	79
(1) Observing the maintenance inspection information	80
(2) Releasing procedure of the warning	81
(3) Observing the production control information	82
(4) Performing setting of the production control information	84
(5) Observing the operation measurement information.....	86
16. USING THE COMMUNICATION FUNCTION	88
(1) Handling possible data	88
(2) Performing communication by using the media.....	88
(3) Performing communication by using USB	88
(4) Take-in of the data	89
(5) Take-in of plural data together	90
17. PERFORMING FORMATTING OF THE MEDIA.....	92

VII. MAINTENANCE	93
1. INSPECTION	93
(1) Maintenance and inspection of the pneumatic device	93
(2) Maintenance and inspection related to the sewing machine	93
(3) With regard to the waste oil of the hook oil	94
(4) With regard to the cleaning of the hook shaft base.....	94
2. MARKING LIGHT	95
(1) Marking light for sewing reference setting	95
(2) Adjusting the marking light irradiation position.....	95
3. REPLENISHING GREASE TO THE DESIGNATED PLACE	96
(1) Grease-up procedure	97
4. CONSUMABLE REPLACEMENT COMPONENTS	99
5. TILTING THE MACHINE	101
6. STANDARD OF REPLACING TIME OF THE GAS SPRING	102
7. REPLACING PROCEDURE BETWEEN DOUBLE-WELT AND SINGLE-WELT	103
(1) Replacing procedure between double-welt and single-welt.....	103
(2) Fine adjustment of the position of garment body clamp	103
(3) Replacing the binder	104
8. ADJUSTING THE CORNER KNIFE	105
9. ADJUSTING THE POSITION OF THE SENSOR FOR DETECTING FLAPS	106
10. CAUSES AND CORRECTIVE MEASURES AGAINST TROUBLES WITH THE BOBBIN THREAD	
REMAINING AMOUNT DETECTING DEVICE	107
11. HOW TO ADJUST THE FOOT PEDAL	108
12. ERROR CODE LIST	110
13. INPUT NUMBER TABLE	120

I. CAUTIONS BEFORE OPERATION

Following items have to be checked every working day before the operation of the machine and before the start of work hours.

1. **Ascertain that the sewing machine is filled with the predetermined amount of oil.**
2. **Never operate the machine unless the lubricating part in the hook has been filled up with oil.**
3. **Ascertain that the pressure gauge indicates the designated air pressure of 0.5 MPa.**

*** (This is necessary particularly when the compressor is stopped for a lunch break or the like.)**

If the compressed air pressure is equal to or less than the designated value, troubles such as interference between the parts can occur. It is therefore necessary to carefully check the compressed air pressure.

4. **Check whether the needle thread/bobbin thread need to be replenished.**
5. **To perform sewing immediately after turning ON the power switch, perform trial stitching first, then proceed with sewing of actual products after the test sewing.**
6. **In order to prevent the optical fiber sensor of the bobbin thread remaining amount detecting device from showing a detecting failure, be sure to clean thread waste around the hook using an air gun once or more times a day.**
7. **In order to protect the flap sensor from showing a detecting failure, be sure to clean dust on the reflecting tape of the folding plate using an air gun once or more times a day.**

II. CONFIGURATION OF THE MACHINE

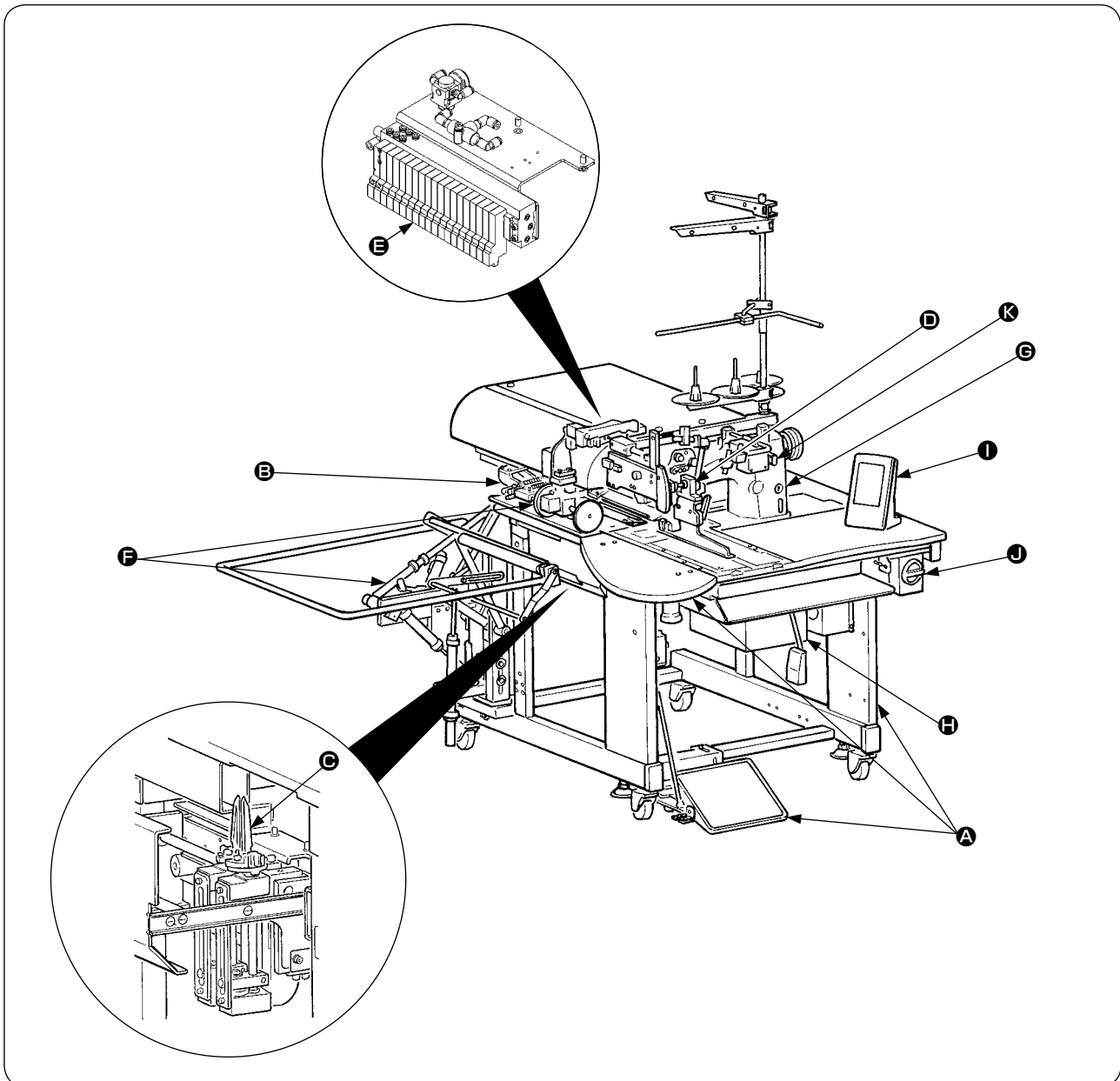

The APW-895 consists mainly of the following units.

- Ⓐ Frame and structural components (Framesewing table, covers, foot switch, etc.)
- Ⓑ Clamp foot unit and feed mechanism
- Ⓒ Corner knife unit
- Ⓓ Binder unit (Binder components and its driving components)
- Ⓔ Pneumatic control unit (Pneumatic control devices and pipings)
- Ⓕ Stacker unit (Optional)
- Ⓖ Sewing machine head
- Ⓗ Electric control unit (Control panel)
- Ⓘ Operation panel
- ⓵ Power switch (Also used as the emergency stop switch)
- Ⓚ Temporary stop switch

With this machine consisting of the aforementioned 11 units, you can do desired welting work simply by setting materials (garment body, interlining piece, welting patch, etc.) in place and operating the switches on the operation panel.

In addition, when temporary stop switch Ⓚ is pressed during operation of the device, the device stops.

III. SPECIFICATIONS

1. MECHANICAL SPECIFICATIONS

1	Sewing machine	LH-895 model of 2-needle, lockstitch machine with a center knife
2	Sewing speed	3,000 sti/min (max.)
3	Stitch length	Lockstitch : 2.0 to 3.4 mm (standard : 2.5 mm) Condensation stitch : 0.5 to 1.5 mm (standard : 1.0 mm) Back tack stitch : 0.5 to 3.0 mm (standard : 2.0 mm) Condensation/Back tack stitch selectable
4	Types of welt	Parallel double welt, } Each with flap or without flap parallel single welt
5	Pocket lip length (Welt length)	Standard type : Possible to set in increments of 1 mm within the range of min. 18 to max. 220 mm Note that the pocket length is min. 35 mm when using the corner knife. (Min. 50 mm in case of 14 mm gauge or more, and min. 21 mm by adding a solenoid valve) For the long and wide type : Possible to set in increments of 1 mm within the range of min. 18 to max. 250 mm Note that the pocket length is min. 70 mm when using the corner knife. (Min. 56 mm by adding a solenoid valve) Possible to set max. 300 mm without entering corner knife.
6	Welting width (Needle gauge)	8, 10, 12, 14, 16, 18 and 20 mm (M004 Long and wide type : 22, 24, 26, 28, 30 and 32 mm) * However, for SA117 with dart stretcher, 8, 10, and 12 mm For SA125 with zipper attachment, 16 mm, 18 mm, 20 mm
7	Needles	ORGAN DP X 17 #14 to #18 (standard #16)
8	Thread	Spun thread #60 (Recommended)
9	Hook	Full rotary, vertical-axis, self-lubrication hook
10	Thread take-up lever	Slide thread take-up lever
11	Needle bar stroke	33.3mm
12	Cloth feed mechanism	Driven by stepping motor
13	Control	By a micro-computer
14	Safety mechanism	Machine operation is automatically stopped if the cloth feed mechanism error detector, the needle thread breakage detector or any of the various safety devices is actuated.
15	Lubricating oil	JUKI New Defrix Oil No. 1
16	Operating air pressure	0.5 MPa
17	Air consumption	Approx. 40 Nℓ/min.
18	Dimensions of machine	Width : 1,095 mm (1,580 mm - when including the stacker) Length : 1,500 mm Height : 1,165 mm (1,800 mm - when including the thread stand)
19	Weight	238.5kg
20	Noise	- Equivalent continuous emission sound pressure level (L _{pA}) at the workstation : A-weighted value of 78.5 dB; (Includes K _{pA} = 2.5 dB); according to ISO 10821- C.6.3 -ISO 11204 GR2 at 3,000 sti/min for the sewing cycle, 4.5s ON. (Pattern : No.1, Jump feed speed of clamp foot : Max speed).

2. ELECTRICAL SPECIFICATIONS

1	The number of independent sewing patterns that can be stored in memory	99 (1 to 99)
2	The number of alternate sewing patterns that can be stored in memory	20 (1 to 20)
3	The number of cycles that can be stored in memory	20 (1 to 20)
4	Input power: Single phase/3-phase	200 to 240V 50/60 Hz (Optional 380V) Voltage fluctuation: Within + 10% of the rated voltage
5	Power consumption	350VA

IV. INSTALLATION

1. REMOVING PACKING MATERIALS

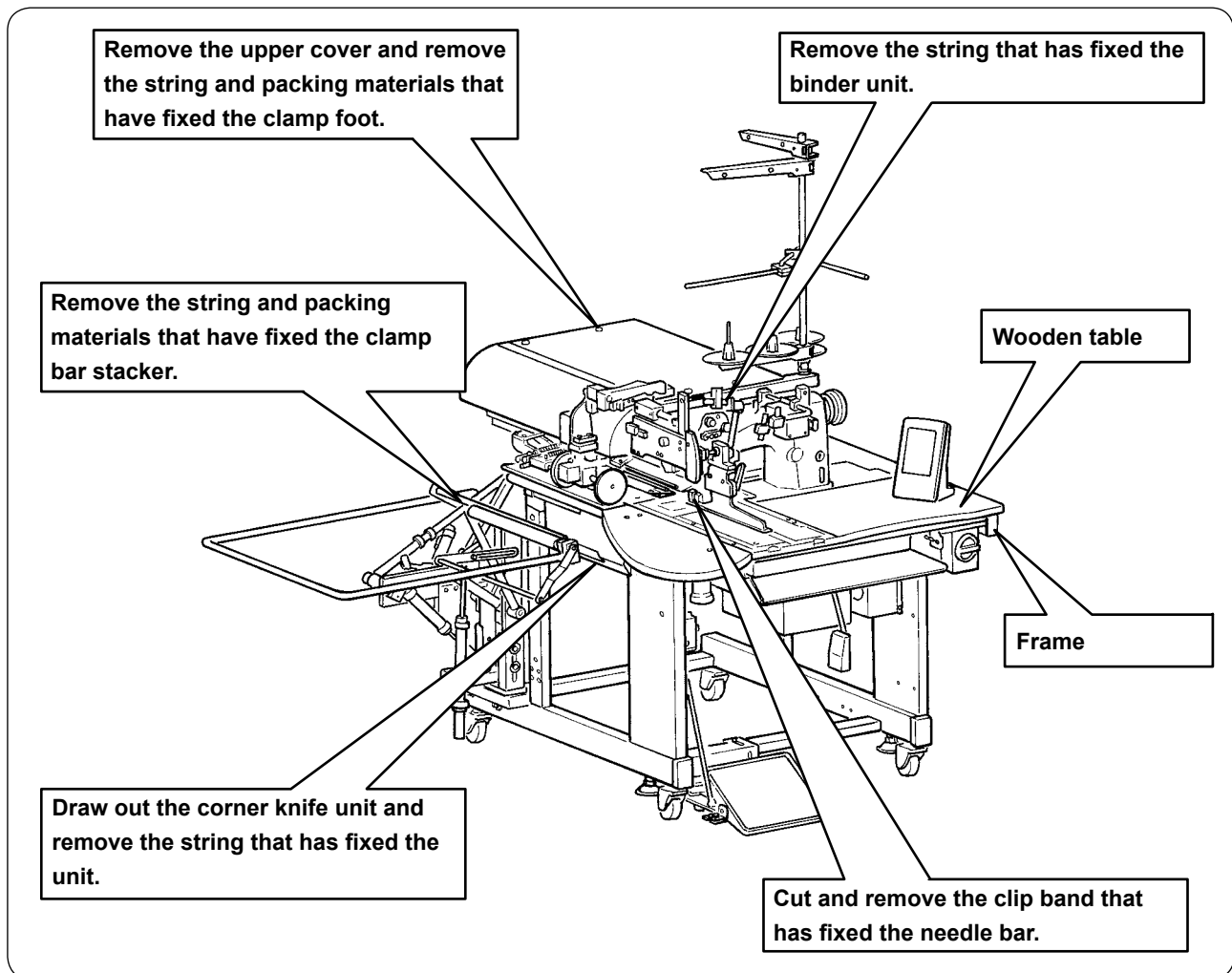

When lifting the machine, hold the frame without holding the wooden table.

2. SECURING THE MACHINE



CAUTION :

To prevent a fatal accident, lower and fix adjust bolts ② (4 places) located at the side of caster ① after moving the machine to the level and stabilized place.

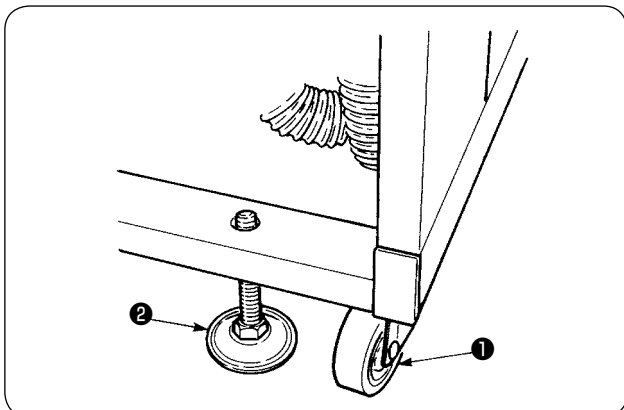

3. CONNECTING THE FOOT PEDAL



CAUTION :
When installing the pedal, perform the work paying attention to the overhead table.

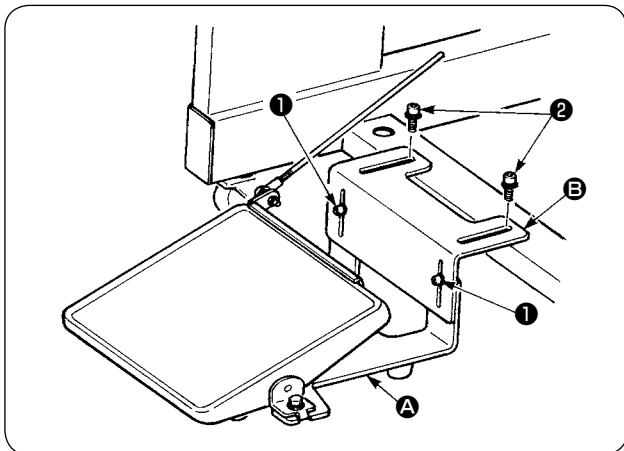

- ① Install the pedal base to the machine frame with screws ② .
- ② Connect pedal bases A and B with two screws ① .



Position of the pedal can be optionally adjusted within the range of the slot.

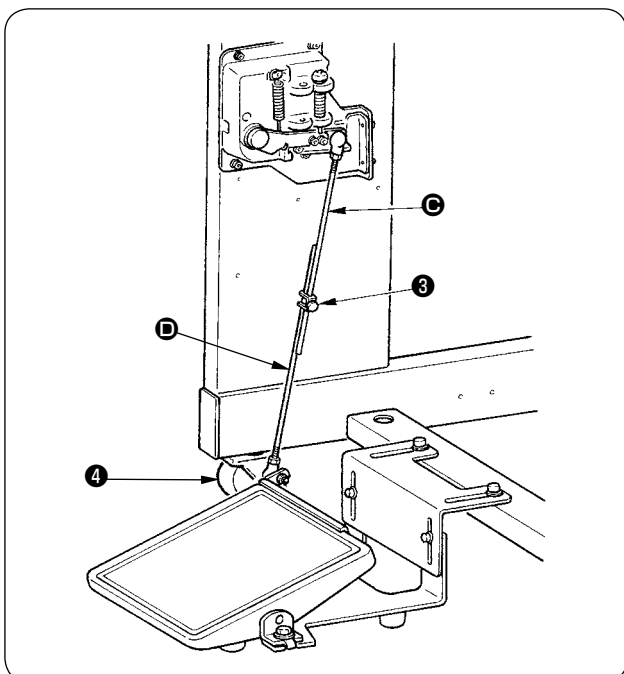

- ③ Connect the connecting rods with fixing screw ③ .



1. When connecting, do not connect the rods with connecting rod C on the sensor side pulled downward,
2. Install so that connecting rod on the pedal side D and the caster 4 do not interfere with each other within the range of pedal operation.

4. CONNECTING THE AIR COUPLER

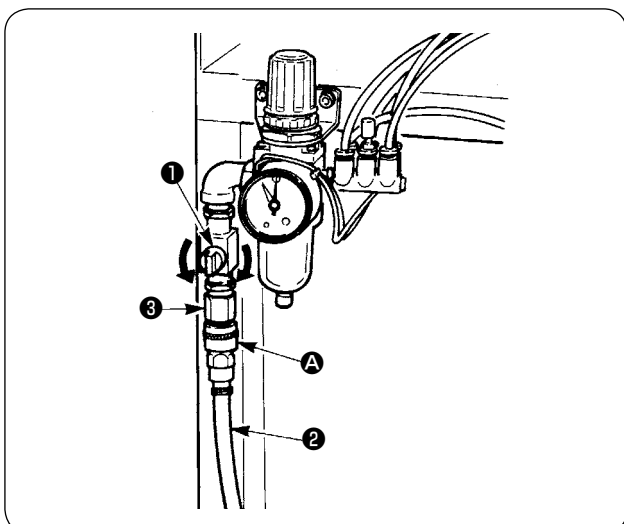

Connect one end of air coupler A supplied with the machine as an accessory to air hose ② . Then connect the other end to coupler ③ on the main unit side.



- Connect coupler A to the main unit with air cock ① closed, then carefully open air cock ① to allow the compressed air to be supplied.
- Make sure that the pressure gauge of the regulator reads 0.5 MPa.

5. CONNECTING THE POWER PLUG



CAUTION :

To prevent possible accidents caused by leakage or dielectric strength, an appropriate power plug shall be installed by a person who has an expert knowledge of electricity. Be sure to connect the power plug to the receptacle that is well grounded.

Connection of the power plug to the power depends on the specifications of the product. Adjust the power plug to the power specifications to connect.

- ① In case of the product of single-phase, 200 to 240V specifications :
Connect the sky-blue and brown wires of the power cord to the power terminal (AC200 to 240V) and the yellow/green wire to the ground (earth) terminal respectively.
- ② In case of the product of 3-phase, 200 to 240V specifications :
Connect the red, white and black wires of the power cord to the power terminal (AC200 to 240V) and the yellow/green wire to the ground (earth) terminal respectively.
- ③ In case of the product with the optional high voltage transformer (with SA-128) :
Connect the black wires (3 pieces) of the power cord to the power terminal (AC380 to 415V) and the yellow/green wire to the ground (earth) terminal respectively.
It is possible to connect to 380/400/415V by setting of the input tap of transformer (standard setting at the time of delivery : 380V).



This product performs operation by the single-phase connection for 3-phase 380/400/415V.

[Caution when changing the power source of the high voltage optional transformer]

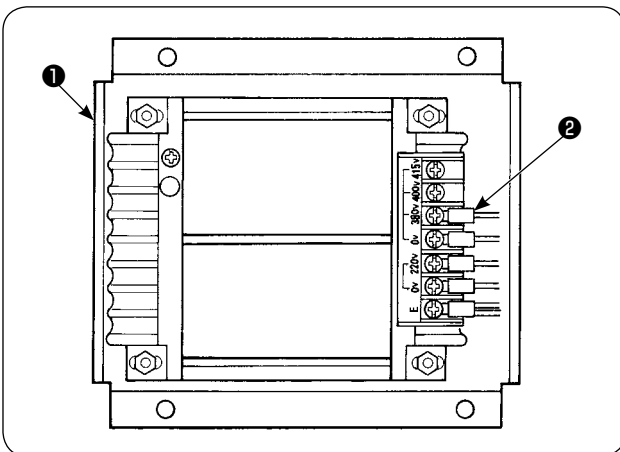

When using high voltage optional transformer ① with the input voltage of 400V or 415V, it is necessary to replace input power source cord ② of high voltage optional transformer ①. Change power source input cord ② (sky blue) that is connected to 380V to the connection of 400V or 415V.



To prevent accidents, perform the work after leaving the sewing machine alone more than 4 minutes in the state that the power switch is turned OFF and the power cord is drawn out.

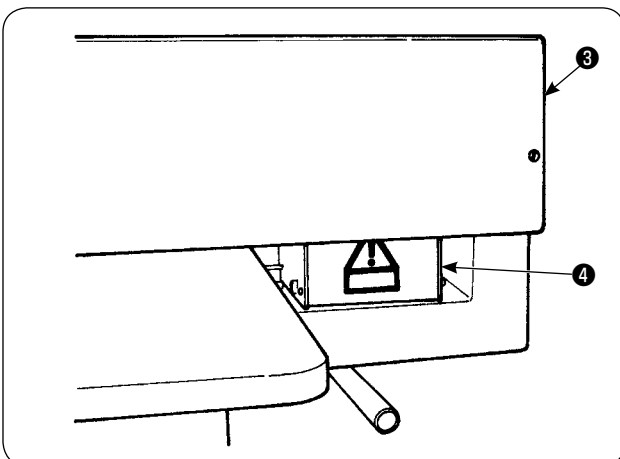

High voltage optional transformer ① is set on the rear side of the table.

When performing changeover of voltage, remove transformer box ④ after removing top cover ③.

6. ASSEMBLING THE THREAD STAND AND ATTACHING IT TO THE MACHINE

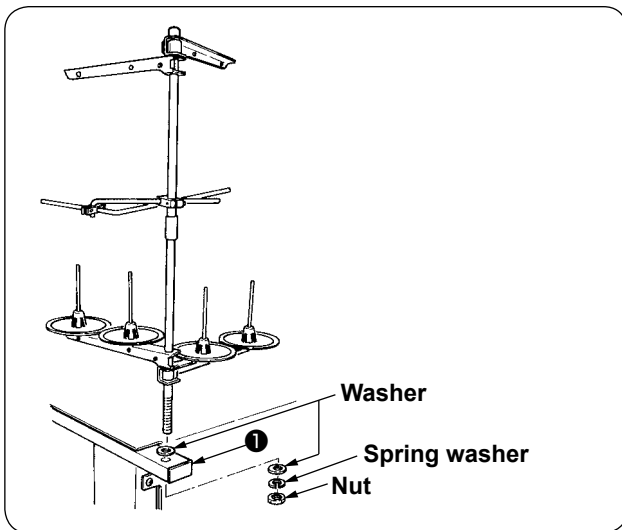

Putting nut and washer between main unit frame ① and fix the thread stand as illustrated in the left-hand figure.

7. INSTALLING SP-46 (CLAMP BAR STACKER) (OPTIONAL PART NO. : 40058952)

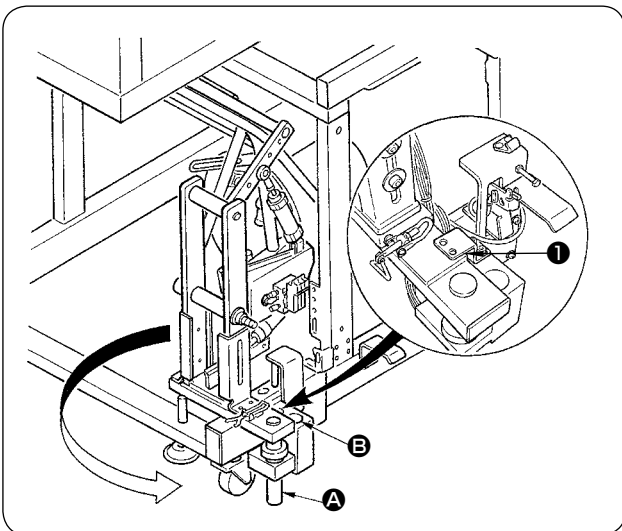

Clamp bar stacker is delivered in the state that it is fixed in the frame at the time of delivery with the clamp bar stacker mounted. It is necessary to change the installing position to the normal using position.



- ① Remove stacker fixing plate ①.
- ② Turn the whole stacker in the direction of the arrow and take it out from inside of the frame.
- ③ Change stacker turning shaft A section to stacker base hole B.



At this time, take care to prevent the stacker cord, the air piping, etc. from being caught.

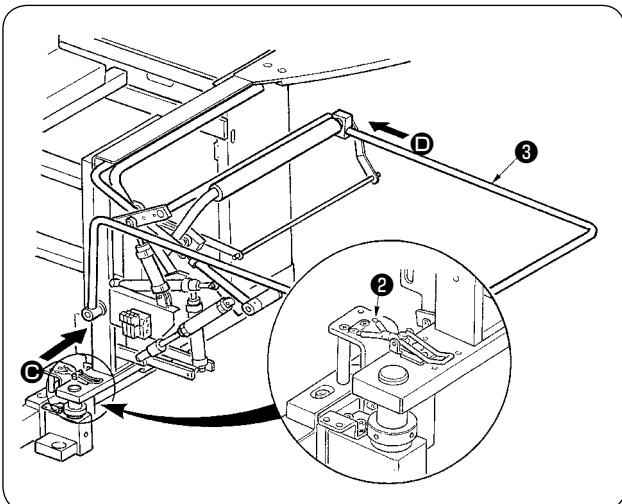

- ④ Lock the whole stacker with hinge ②.
- ⑤ Enter safety bar ③ from C and D directions and fix it at the position where is almost parallel to the floor.



At this time, confirm that air is being supplied.

8. INSTALLING SP-47 (ROLLER STACKER) (OPTIONAL PART NO. : 40058953)

(1) Adjusting the position

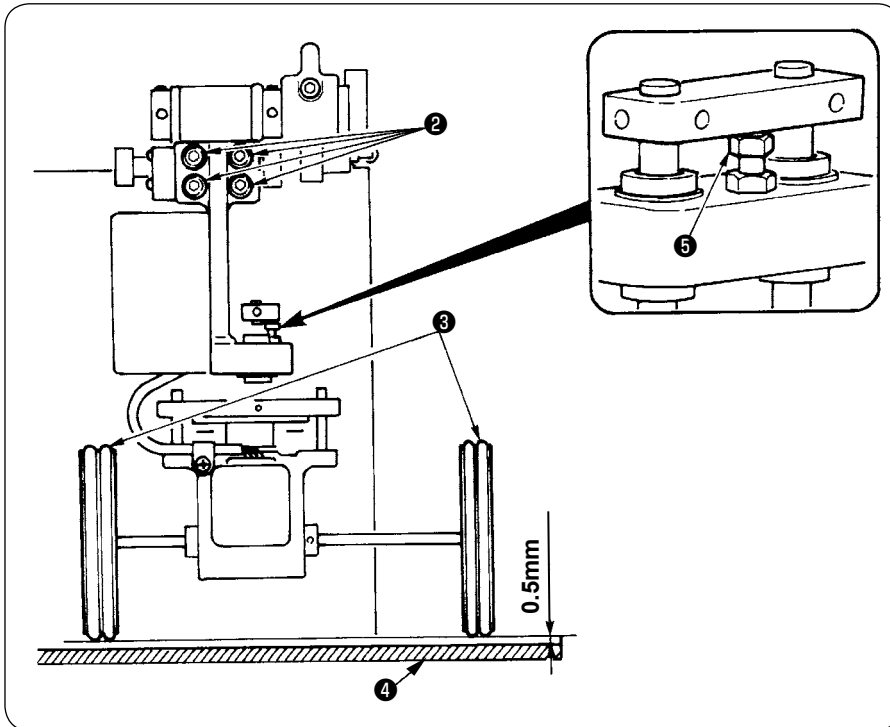

- ① Confirming parallelism
Make sure that stacker table ④ and rubber roller ③ are installed parallel with each other.
If not, loosen four set-screws ② to adjust.
- ② Confirming the clearance
Make sure that the clearance between stacker table ④ and rubber roller ③ is approximately 0.5 mm.
If it is not approximately 0.5 mm, loosen nut ⑤ to adjust.

(2) Maintenance

(Working state)

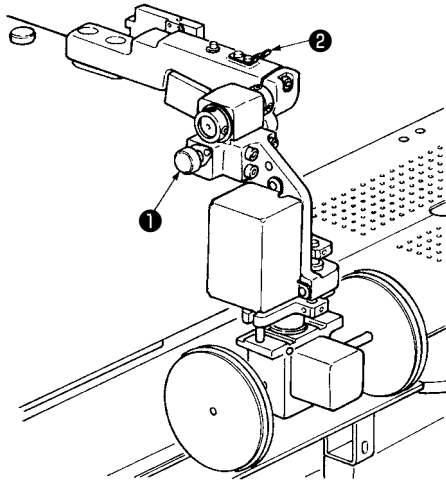

When the roller stacker is not used or adjusting the corner knife, the roller stacker can be turned upward with the procedure below.

Pull release lever ①. Lift up the roller section to thrust pin ③ into fixing spring ②, then bring them into locked state (see Fig. 1). This puts the sewing machine in standby state.

Fig. 1

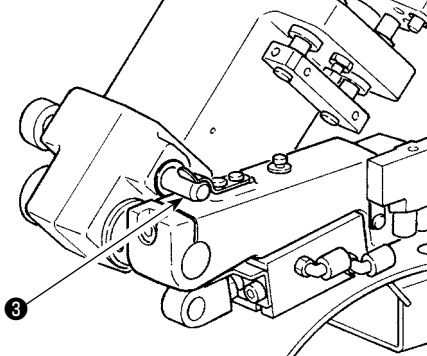

(Waiting state)

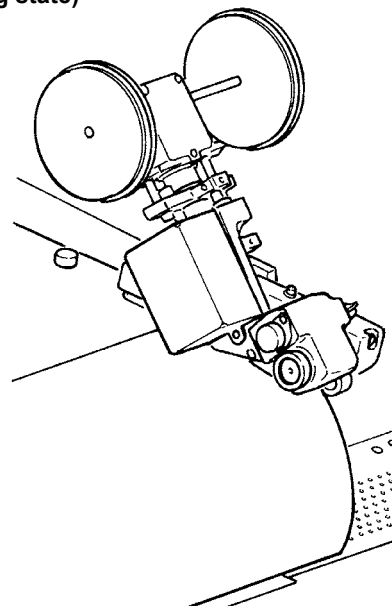

9. REMOVING THE HEAD FIXING PLATE

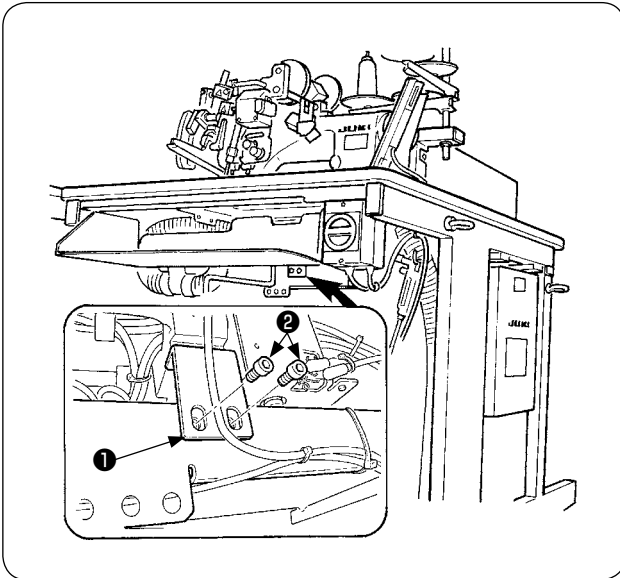

Remove fixing screws ② of head fixing plate ①.



Be sure to fix the machine and the frame when performing re-transportation.

10. INSTALLING THE SUB-TABLE

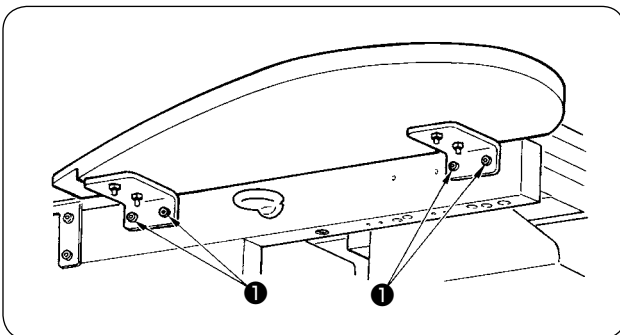

Install the sub-table with four screws ① as shown in the figure.



At this time, fix the sub-table so as to be flush with the main table.

11. INSTALLING OPERATION PANEL IP-420

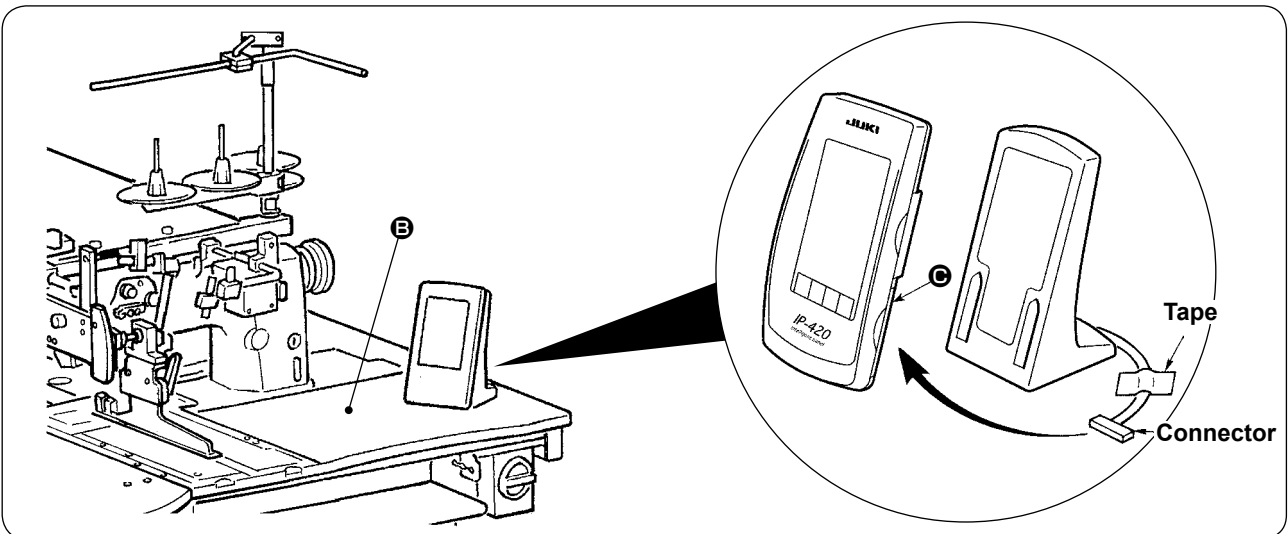

As shown in the figure above, open the lid on the right-hand section ③ of IP-420 and connect the connector which is fixed with tape to the right-hand top surface ③ of the table.



To prevent malfunction due to static electricity, install operation panel IP-420 on the panel base to use and do not change the position of the panel base.

12. LUBRICATING THE OIL TANK

CAUTION :



1. To prevent accidents caused by abrupt start of the sewing machine, do not connect the power plug until lubrication has been completed.
2. To prevent inflammation or rash, immediately wash the part when oil has stuck to your eyes or body.
3. If oil has been swallowed, diarrhea or vomiting may occur. Put oil to the place where children cannot reach.

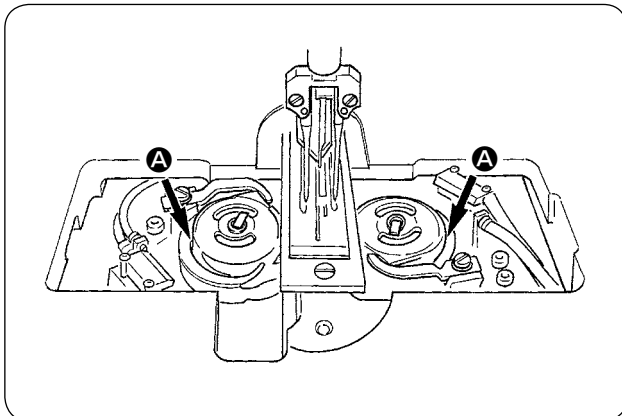
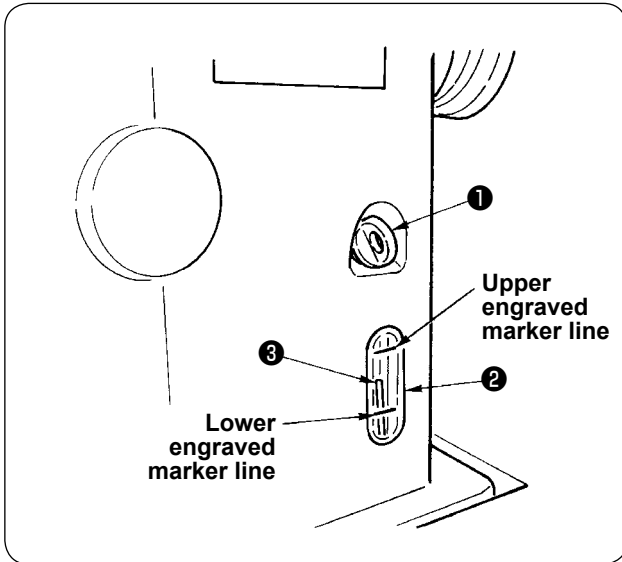

Fill the oil tank with the oil for hook lubrication before operating the sewing machine.

- ① Remove oil cap ① and fill the oil tank with JUKI MACHINE OIL No. 1 (Part No. : MD-FRX1600C0) using the oiler supplied with the machine as accessories.



To prevent entering of dust, be sure to attach the cap for use.

- ② Fill the oil tank with the oil until the top end of oil amount indicating rod ③ comes between the upper engraved marker line and the lower engraved marker line of oil amount indicating window ② .

When oil amount is excessively large, oil leaks from the air hole or adequate lubrication cannot be performed. So, be careful.

- ③ When operating the sewing machine and the top of oil amount indicating rod ③ has lowered up to oil amount indicating window ② , start lubricating.



- At the time of initial filling, fill the oil tank with oil of 200cc as the standard and confirm that the oil amount indicating rod is working.
- When operating a newly installed machine or a machine which has not been used for a relatively long period of time, make the machine run at 2,000 sti/min or less for the purpose of break-in. In addition, use the machine after applying oil to races A of the right/left hooks.
- For the oil for hook, purchase JUKI MACHINE OIL No. 1 (Part No. : MD-FRX1600C0).
- Be sure to fill the oil tank with clean oil.

13. INSTALLING SA-120 (INTERLINING SUPPLYING DEVICE) (OPTIONAL PART NO. : 40045772)



CAUTION :

Turn OFF the power before starting the work so as to prevent accidents caused by abrupt start of the sewing machine.

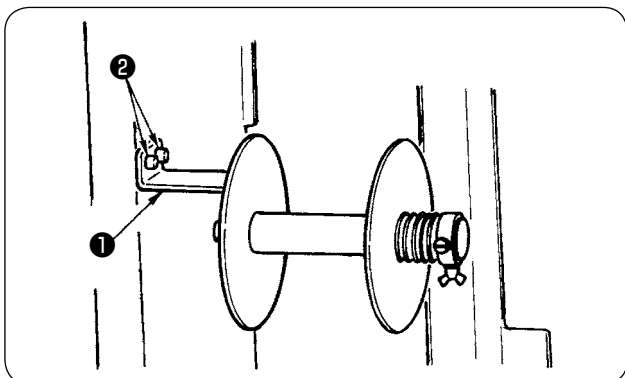

* It cannot be used for the long and wide type.

- ① Fix interlining installing plate ① to the machine frame with two screws ② .

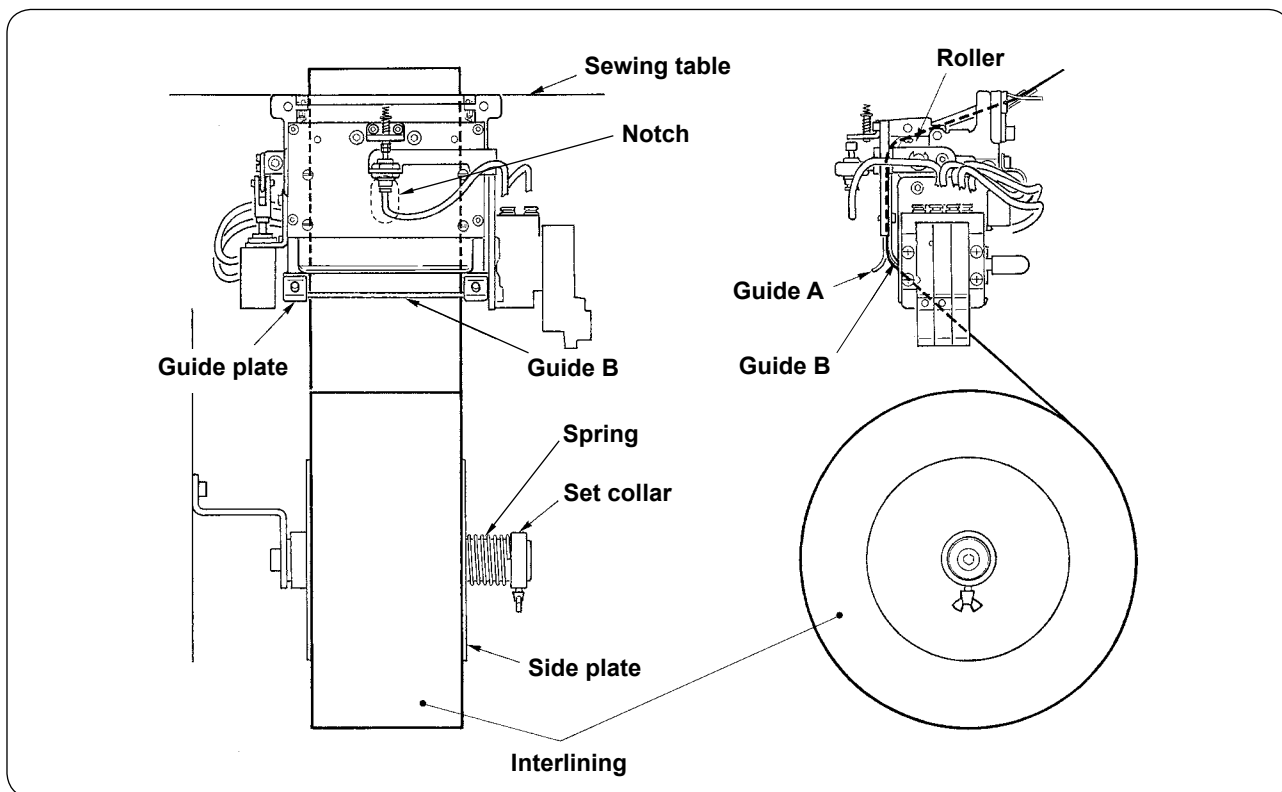

- ② Set interlining as shown in the figure above.
The roll core that can be used is 40 to 70 mm wide and 200 mm in roller diameter (max.).
- ③ Pass the interlining between guide B and guide A and roller, and route it up above the table.



Feed the interlining up to the roller section using the notch of the guide plate.

- ④ Adjust the lateral position of two guides, two guide pins and side plate (on the right) to allow the interlining to be fed straight up above the sewing table.
- ⑤ Position the set collar on the left-hand side to allow the side plate to lightly hold the interlining by spring. Then fix the set collar there.

14. ADJUSTMENT OF SA-120 (INTERLINING SUPPLYING DEVICE) (OPTIONAL PART NO. : 40045772)



CAUTION :

Turn OFF the power before starting the work so as to prevent accidents caused by abrupt start of the sewing machine.

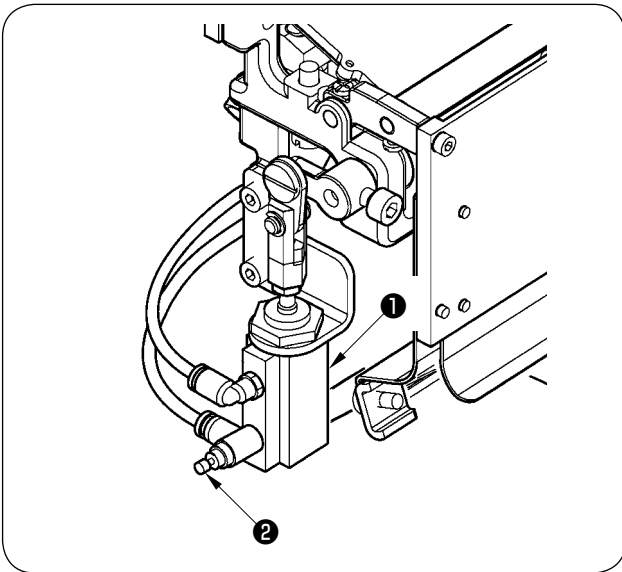

- ① Adjustment of the interlining feeding amount is performed with memory switch (U003). However, perform further fine adjustment with the speed controller ② of the interlining feeding cylinder ① .
(When tightening the speed controller ② , the amount is decreased and when loosening it, the amount is increased.)

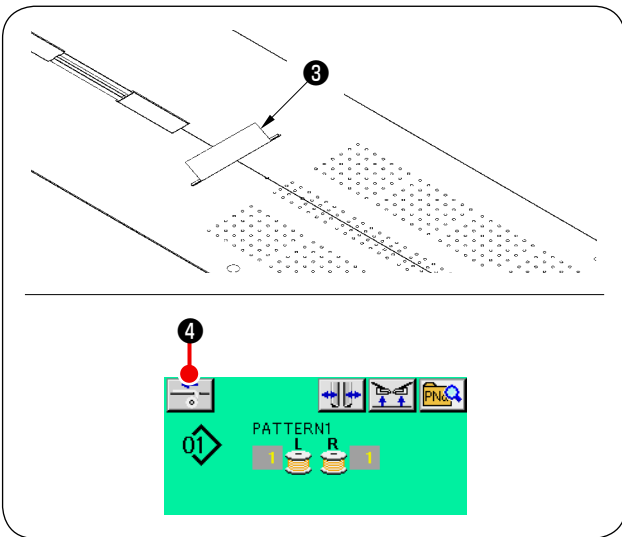

- ② When a new interlining ③ is mounted, press interlining supply button ④ , perform feeding of the trial sewing several times and use the device after confirming the feeding amount and the parallel feeding of the interlining.

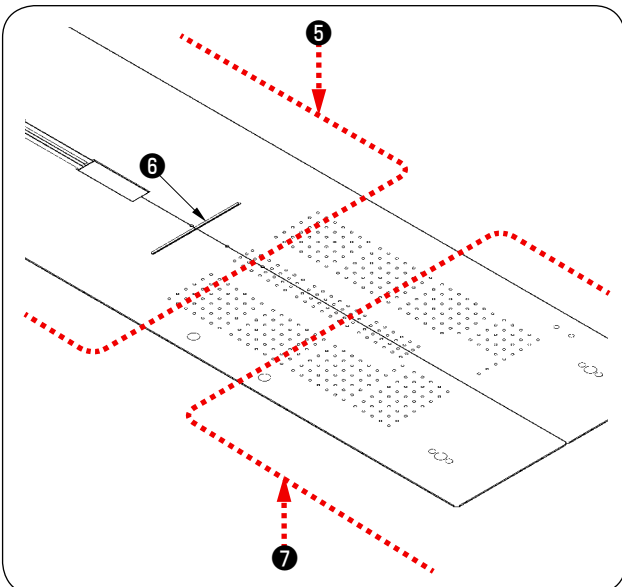

(Caution when operating)

When using the interlining supplying device with rear reference ⑤ , the interlining at the sewing start remains long since it is away from interlining outlet ⑥ . So, use the device with front reference ⑦ .



For handling the sewing tables, refer to "V-2.(2) Cautions to be taken when the sewing tables are removed" p. 16

V. PREPARATION OF THE SEWING MACHINE

1. HOW TO OPERATE THE SEWING MACHINE HEAD

(1) How to attach the needles



CAUTION :

- Turn OFF the power before starting the work so as to prevent accidents caused by abrupt start of the sewing machine.
- When replacing the needle, be careful not to allow your fingers to touch the blade section of the center knife.

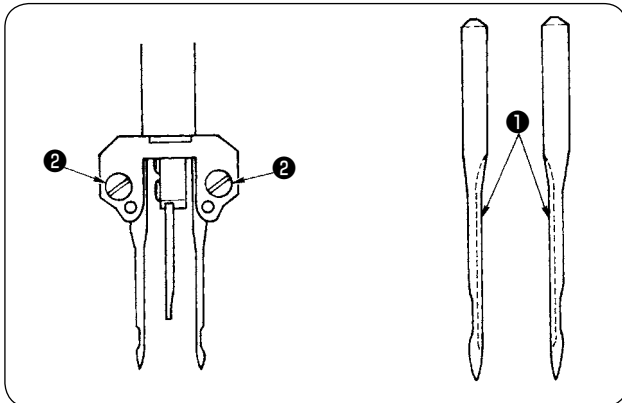

Needles used are DP X 17 #14 to #18 (standard #16). Use the specified needle.

Insert left- and right-hand sides needles as far as they will go pointing their long grooves ① at each other and tighten needle clamp screws ② .

(2) Thread used

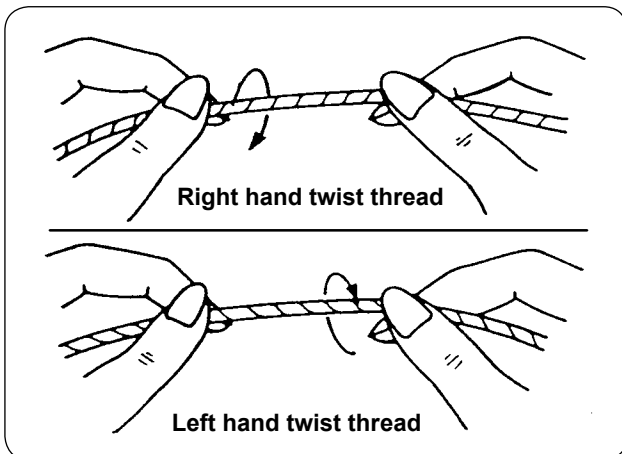

- Use the left hand twist thread for the needle thread.
- Either twist thread will do for the bobbin thread.



Use a new thread which is uniformly twisted.

(3) How to pass the needle thread



CAUTION :

Turn OFF the power before starting the work so as to prevent accidents caused by abrupt start of the sewing machine.

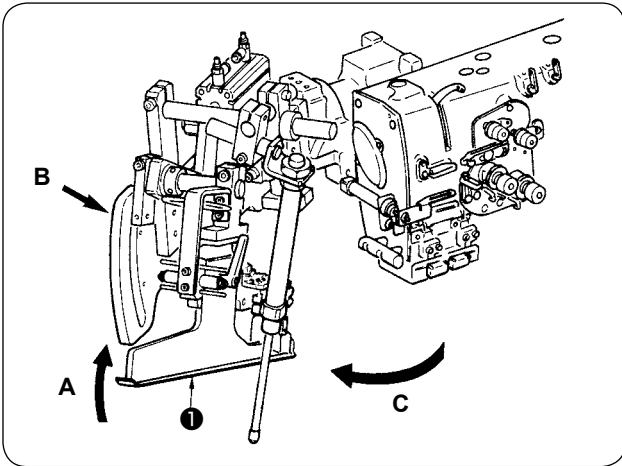

- ① Lift binder ❶ in the direction A, Hold section B by hand and turn the whole binder in the direction C.



Be sure to press section B since welling width may become improper when the binder is pressed and turned in the direction C.



Binder is locked with the ball plunger. Rather strongly turn the binder in the direction C to release the lock.

- ② Then pass needle thread in the order as shown in the figure below.

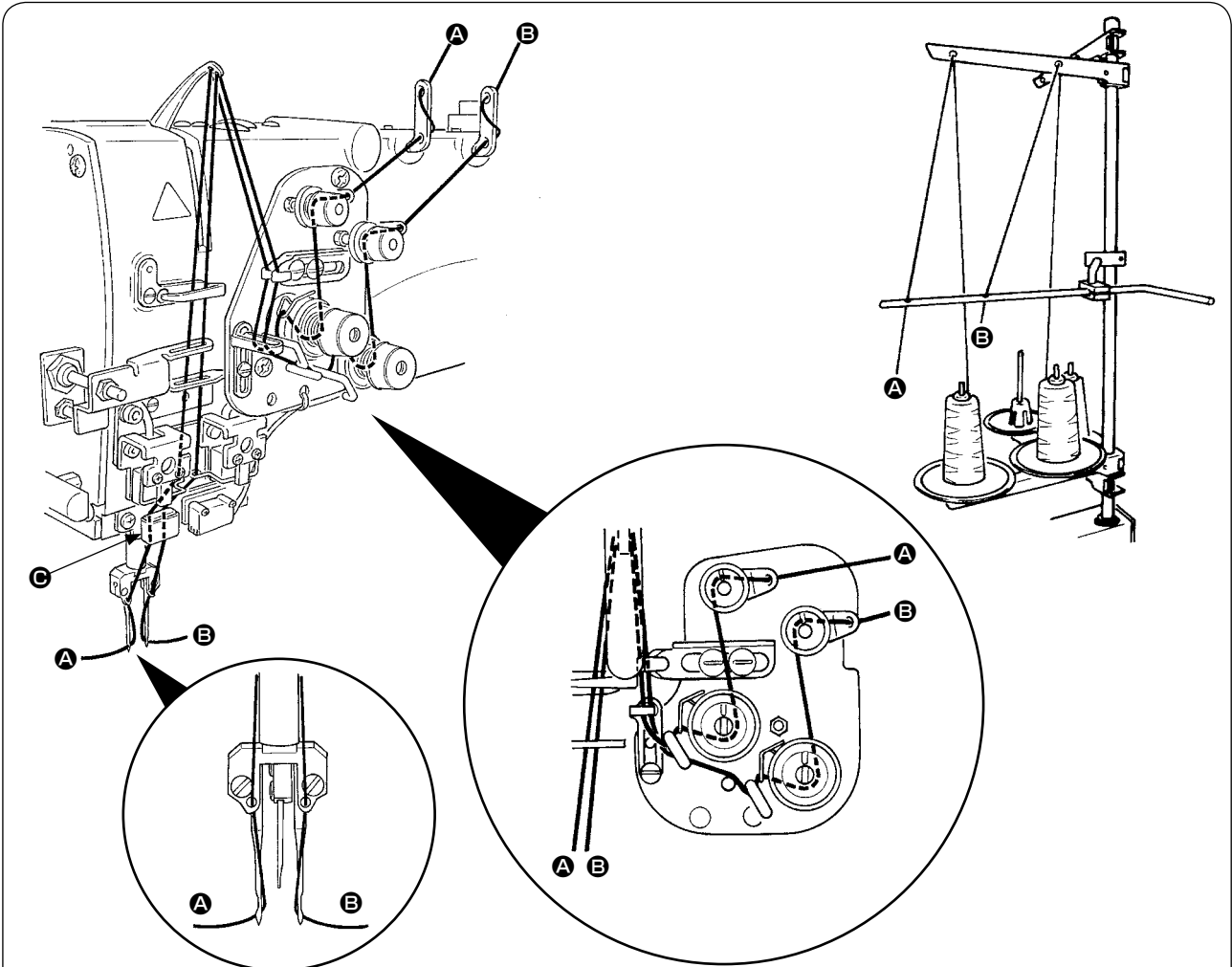

Periodically replace thread guide felt ❷. Sewing trouble due to rough motion of thread during sewing can be prevented.

Pass the needle thread in the illustrated order.

Left-hand side needle thread toward the sewing machine

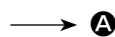

Right-hand side needle thread toward the sewing machine

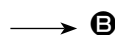

2. HOW TO REMOVE THE SEWING TABLE



CAUTION :

Turn OFF the power before starting the work so as to prevent accidents caused by abrupt start of the sewing machine.

(1) When replacing the bobbin thread

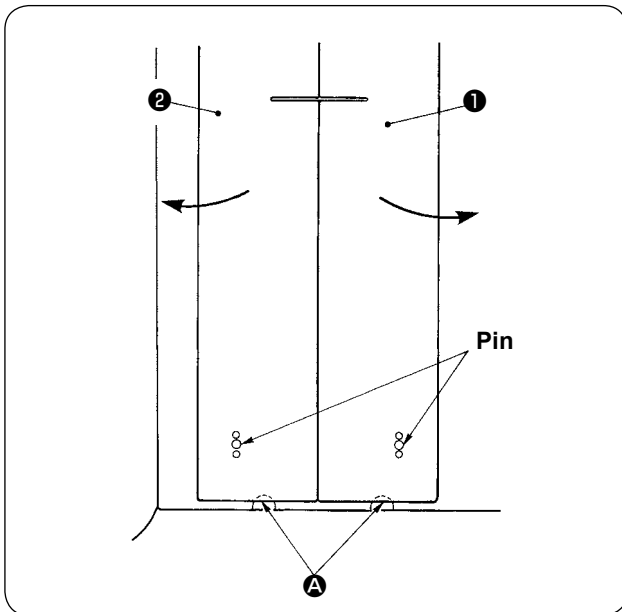

- ① Move the clamp foot to the rear end of its stroke.
- ② Insert your fingers into notches **A** in the bottom of right- and left-hand sewing tables **1** and **2** , and push up the sewing tables.
- ③ Move the tables in the direction of the arrow keeping the above state, and you can see the bobbin case.



At this time, move the sewing tables so as not to allow the sewing tables to come in contact with the needles.

- ④ After replacing the bobbin thread, return the sewing tables in place by following the above-mentioned steps of procedure in the reverse order. Now, firmly set the sewing tables on the throat plates and the pins.

(2) Cautions to be taken when the sewing tables are removed



CAUTION :

Turn OFF the power before starting the work so as to prevent accidents caused by abrupt start of the sewing machine.

When you remove the sewing tables, be sure to accurately set them by following the points below.

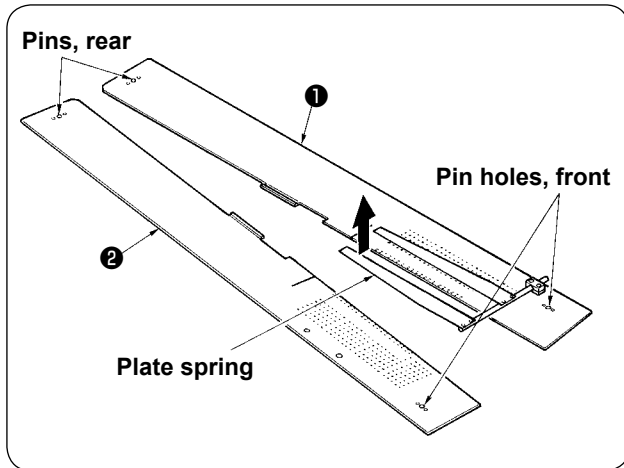

- ① Securely fit the pins, rear (left) (right) over the pin holes.
- ② Securely fit pin holes, front (left) (right) over the pins.



1. In case of the machine provided with SA-120 (automatic interlining supplying device), return the sewing tables to their home positions while lifting the sewing tables so that the plate spring section is not bent.

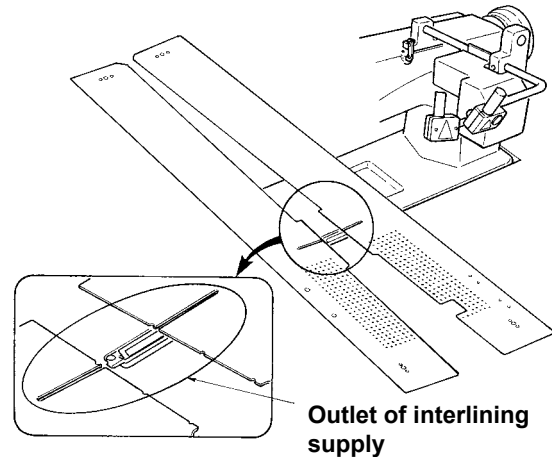

2. In case of removing the sewing tables with the types below, take care not to bend pocket bag clamping device and interlining clamping device.

① Pocket bag clamping device (standard)

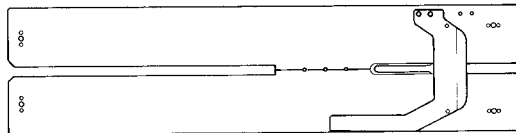

② Pocket bag clamping device (for interlining supply)

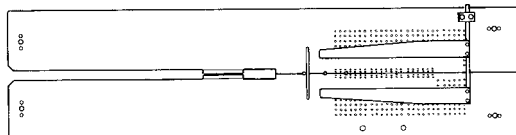

3. HOW TO WIND THE BOBBINS



CAUTION :

To prevent damage, avoid contact with bobbins while the machine is in operation.

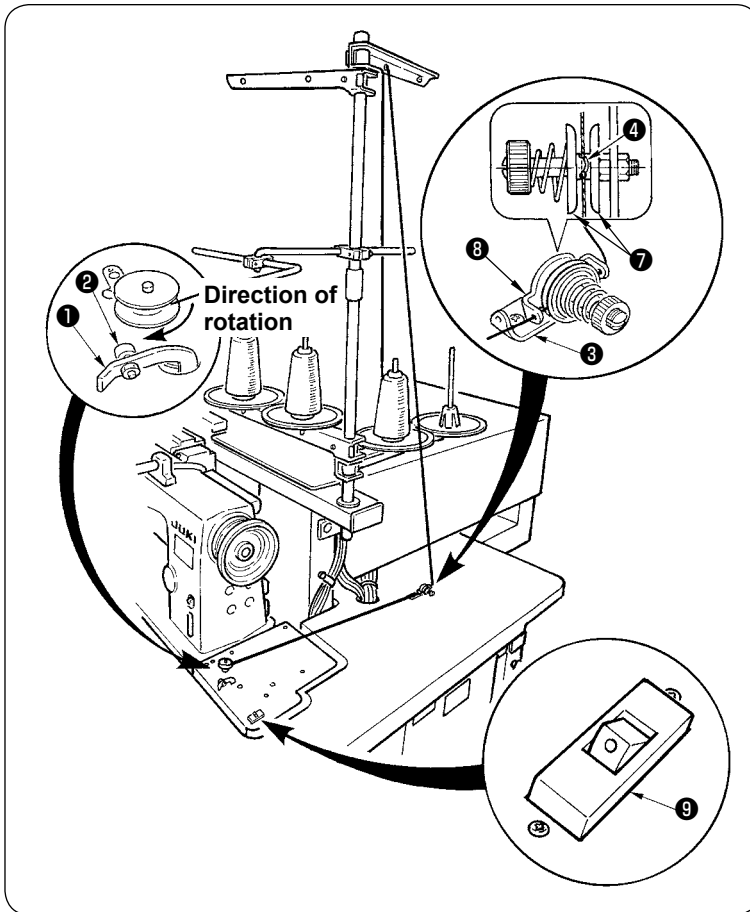

- ① Put bobbin into the thread winder shaft until it will go no further.
- ② Pass thread through thread guide plate ⑧ , open thread tension disk ⑦ and put the thread into the slit of thread tension rod ④ .
- ③ Pass thread in the order as shown in the figure, and wind the thread onto bobbin by four or five turns. (The direction of the arrow corresponds to the direction of rotation of the bobbin.)
- ④ Press bobbin thread guide ① and the bobbin rotates.
- ⑤ The thread winder will automatically stop as soon as it has wound up the bobbin to a predetermined amount.

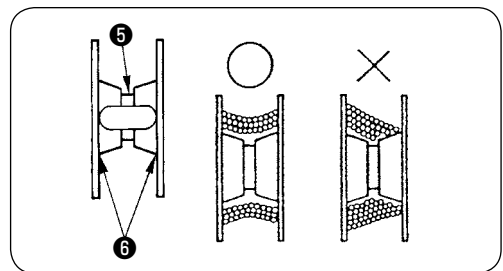

1. If you want to wind a bobbin, start winding it from recess ⑤ as illustrated in the figure above. If you start to wind a bobbin from portion ⑥ , the detection of run-out of bobbin thread will fail to be performed normally.
2. To ensure the appropriate remaining amount of bobbin thread, it is important to wind the bobbin uniformly. Be sure to check that the bobbin is uniformly wound particularly at the start of bobbin winding.
If the bobbin fails to be uniformly wound with thread, properly adjust the lateral position of tension post socket ③ .
3. It is most suitable to wind the bobbin with thread to approximately 80% of the outer diameter of the bobbin. The winding amount can be adjusted with winding amount adjustment screw ② .
4. Do not press lever ① except when winding bobbin thread. Motor continues to run and trouble will be caused.
5. When abnormalities such as overload of the thread winding motor, etc. are detected, thermal switch ⑨ is shut off. When thermal switch is shut off, turn ON thermal switch ⑨ again after turning OFF it to return.



4. HOW TO THREAD THE BOBBIN CASE

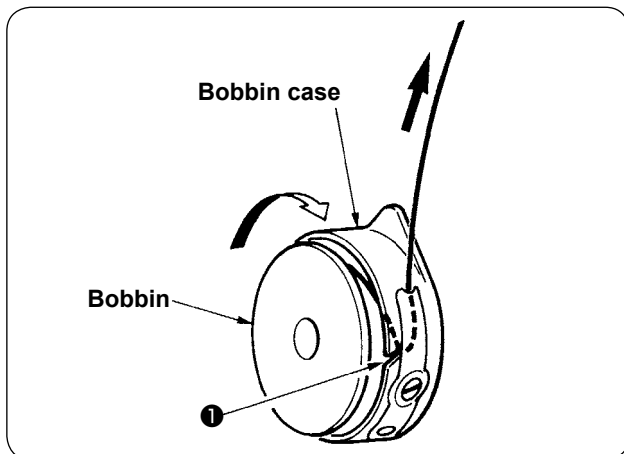

- ① Hold in hand a bobbin in the way that it spins clockwise and put it into the bobbin case.
- ② Pass the thread through slot ① in the bobbin case.
- ③ Pull the thread to pass it under the tension spring.

5. HOW TO INSTALL THE BOBBIN CASE



CAUTION :

Turn OFF the power before starting the work so as to prevent accident caused by abrupt start of the sewing machine.

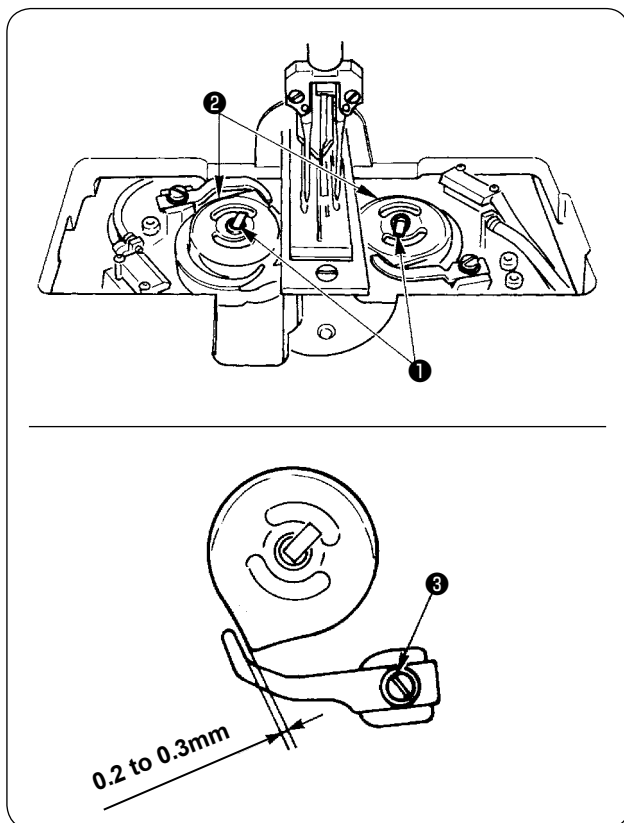

- ① Raise hook levers ① and take out the bobbin cases together with the bobbins.
- ② When fitting, fit the bobbin cases into the hook driving shaft and tilt levers ① .



When bobbin cases, left and right, ② are replaced, make sure that the clearance between the opener which is extremely receded and the bobbin case is 0.2 to 0.3 mm. If the clearance is not 0.2 to 0.3 mm, loosen setscrew ③ and adjust it.

6. HOW TO ADJUST THE THREAD TENSION

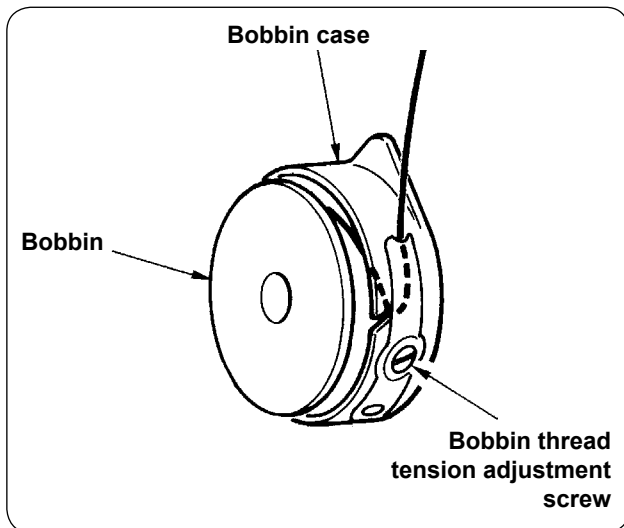

- ① Adjusting bobbin thread tension
Turn bobbin thread tension adjustment screw clockwise to increase the bobbin thread tension or turn the screw counterclockwise to decrease it.

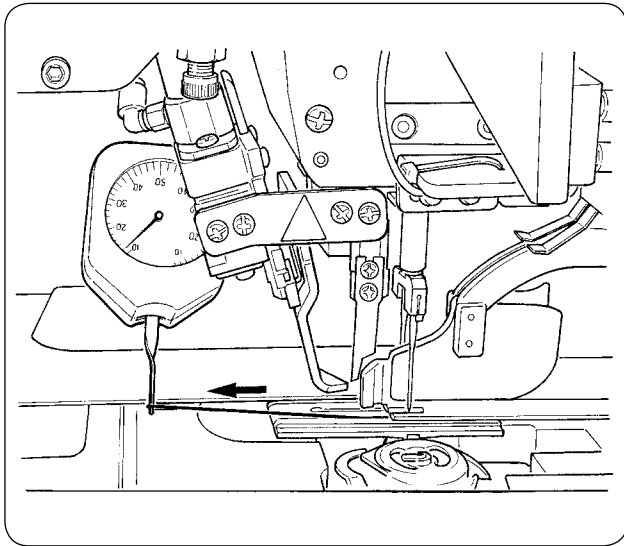

As shown in the left-hand figure, standard bobbin thread tension is 0.25 to 0.35N when measuring with the tension gauge.

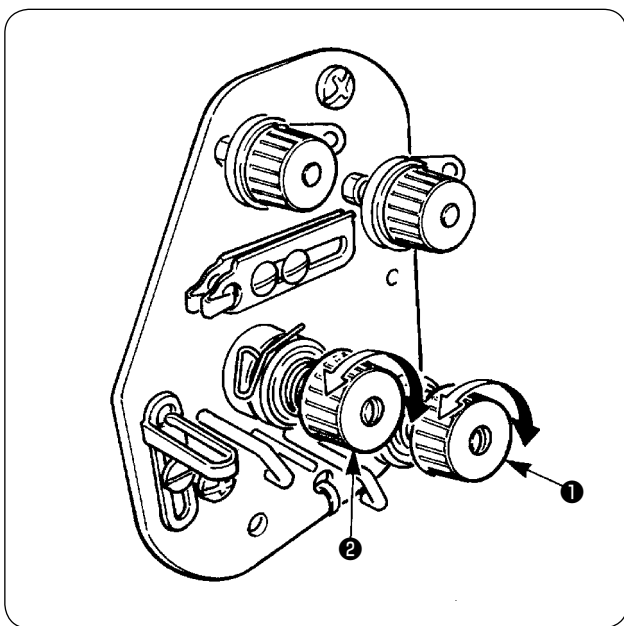

- ② Adjusting needle thread tension
First, adjust the right- and left-hand's bobbin thread tension.
Then in accordance with the bobbin thread tension obtained, adjust the right- and left-hand sides needle threads tension appropriately by turning thread tension adjustments nuts ① and ② respectively. Turning the nuts clockwise will increase the thread tension or turning them counterclockwise to decrease it.

7. SETTING THE MATERIAL TO BE SEWN

(1) Setting a garment body

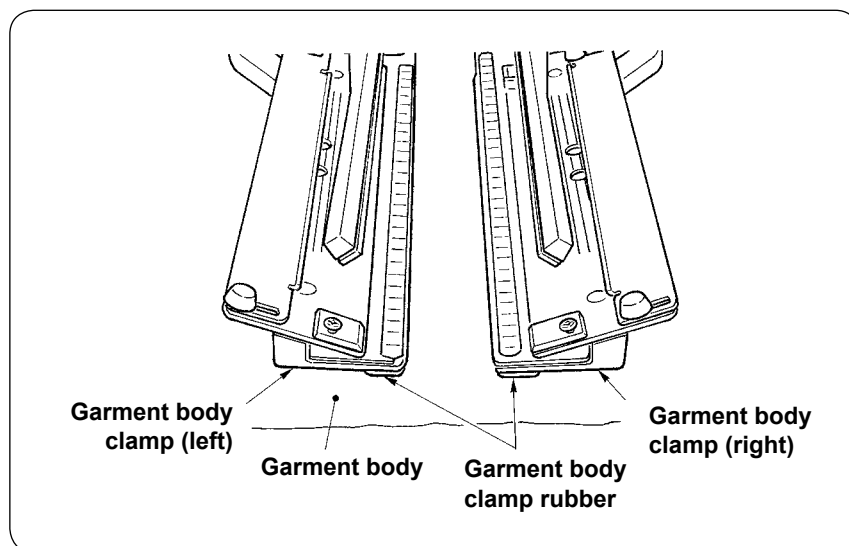

Use a garment body that is larger than the garment body clamp rubber piece adhered under the right and left garment body clamps. If a garment body of which size is smaller than the garment body clamp rubber piece, the rubber piece can come off or the machine can malfunction. If it is necessary to use a small material, mount a shim type gauge (optional) on the machine.

8. ADJUSTING THE MATERIAL GUIDE

Material guide functions to stabilize the welt patch at the edge of the machine needle.

Adjust the height and the presser pressure of material guide ① in accordance with the thickness of material.

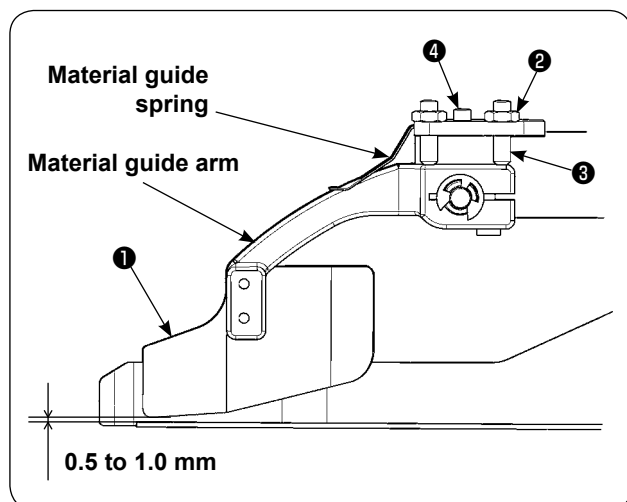

- ① The height of material guide can be adjusted by loosening nut ② and screw ③ .
(Clearance between material guide and welt patch scale has been adjusted to 0.5 to 1.0 mm at the time of delivery.)
- ② Presser pressure can be adjusted with spring pressure adjust screw ④ .
(Adjust the pressure so that there is no excessive resistance when the material passes.)

VI. HOW TO USE THE OPERATION PANEL

1. PREFACE

1) To use the data for APW895/896 (EPD data) on APW-895

To use the EPD data on the APW-895, read the data into the IP-420.

Insert the relevant medium into the IP-420. Select pattern number xxx from EPD data.

2) Folder structure of the media

Store each file in the directories below of the media.



Data that are not stored in the directories above cannot be read. So, be careful.

3) CompactFlash (TM)

■ Inserting the CompactFlash (TM)

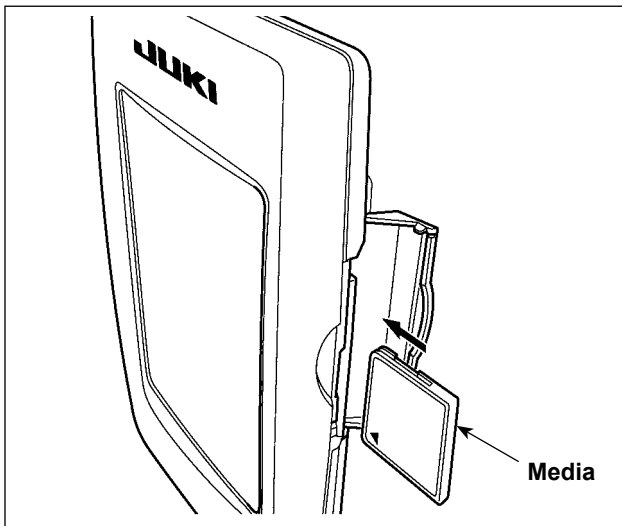

- 1) Turn the label side of the CompactFlash(TM) to this side (place the notch of the edge to the rear.) and insert the part that has a small hole into the panel.
- 2) After completion of setting of the media, close the cover. By closing the cover, it is possible to access. If the media and the cover come in contact with each other and the cover is not closed, check the following matters.
 - Check that the media is securely pressed until it goes no further.
 - Check that the inserting direction of the media is proper.



1. When the inserting direction is wrong, panel or media may be damaged.
2. Do not insert any item other than the CompactFlash (TM).
3. The media slot in the IP-420 accommodates to the CompactFlash (TM) of 2 GB or less.
4. The media slot in the IP-420 supports the FAT16 which is the format of the CompactFlash (TM). FAT32 is not supported.
5. Be sure to use the CompactFlash (TM) which is formatted with IP-420. For the formatting procedure of the CompactFlash (TM), see "[VI-17. PERFORMING FORMATTING OF THE MEDIA](#)" p. 92

■ Removing the CompactFlash (TM)

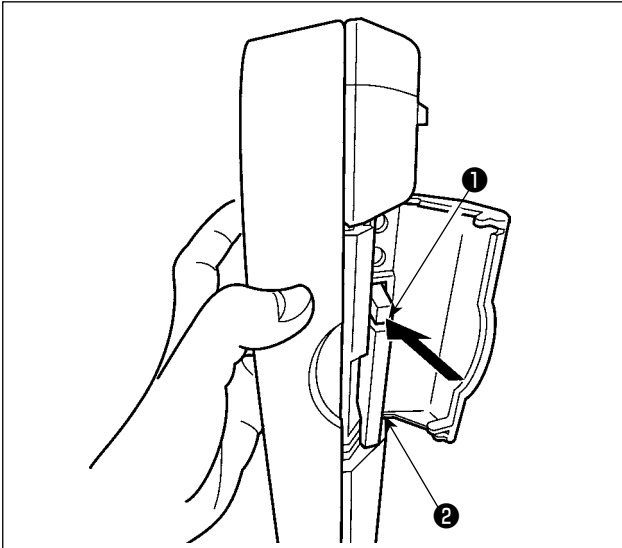

- 1) Hold the panel by hand, open the cover, and press the media ② removing lever ①. The media is eject.



When the lever ① is strongly pressed, the media ② may be broken by protruding and falling.

- 2) When the media ② is drawn out as it is, removing is completed.

4) USB port

■ Inserting a device into the USB port

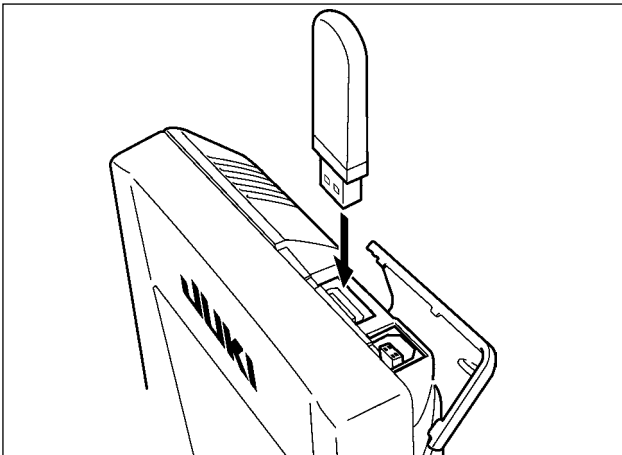

Slide the top cover and insert the USB device into the USB port. Then, copy data to be used from the USB device onto the main body.

After completion of copying the data, remove the USB device.

■ Disconnecting a device from the USB port

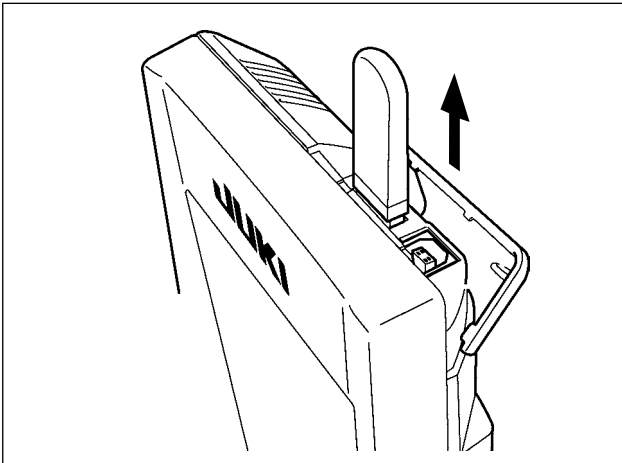

Remove the USB device. Put the cover back in place.

Cautions when using the media



- Do not wet or touch it with wet hands. Fire or electric shock will be caused.
- Do not bend, or apply strong force or shock to it.
- Never perform disassembling or remodeling of it.
- Do not put the metal to the contact part of it. Data may be disappeared.
- Avoid storing or using it in the places below.

Place of high temperature or humidity / Place of dew condensation /

Place with much dust / Place where static electricity or electrical noise is likely to occur

① Precautions to be taken when handling USB devices

- Do not leave the USB device or USB cable connected to the USB port while the sewing machine is in operation. The machine vibration can damage the port section resulting in loss of data stored on the USB device or breakage of the USB device or sewing machine.
- Do not insert/remove a USB device during reading/writing a program or sewing data. It may cause data breakage or malfunction.
- When the storage space of a USB device is partitioned, only one partition is accessible.
- Some type of the USB device may not be properly recognized by this sewing machine.
- JUKI does not compensate for loss of data stored on the USB device caused by using it with this sewing machine.
- When the panel displays the communication screen or pattern data list, the USB drive is not recognized even if you insert a medium into the slot.
- For USB devices and media such as CF(TM) cards, only one device/medium should be basically connected/inserted to/into the sewing machine. When two or more devices/media are connected/inserted, the machine will only recognize one of them. Refer to the USB specifications.
- Insert the USB connector into the USB terminal on the IP panel until it will go no further.
- Do not turn the power OFF while the data on the USB flash drive is being accessed.

② USB specifications





- Conform to USB 1.1 standard
- Applicable devices *1 _____ Storage devices such as USB memory, USB hub, FDD and card reader
- Not-applicable devices _____ CD drive, DVD drive, MO drive, tape drive, etc.
- Format supported _____ FD (floppy disk) FAT 12
Others (USB memory, etc.), FAT 12, FAT 16, FAT 32
- Applicable medium size _____ FD (floppy disk) 1.44MB, 720kB
Others (USB memory, etc.), 4.1MB ~ (2TB)
- Recognition of drives _____ For external devices such as a USB device, the device which is recognized first is accessed. However, when a medium is connected to the built-in media slot, the access to that medium will be given the highest priority. (Example: If a medium is inserted into the media slot even when the USB memory has already been connected to the USB port, the medium will be accessed.)
- Restriction on connection _____ Max. 10 devices (When the number of storage devices connected to the sewing machine has exceeded the maximum number, the 11th storage device and beyond will not be recognized unless they are once disconnected and re-connected.)
- Consumption current _____ The rated consumption current of the applicable USB devices is 500 mA at the maximum.

*1: JUKI does not guarantee operation of all applicable devices. Some device may not operate due to a compatibility problem.

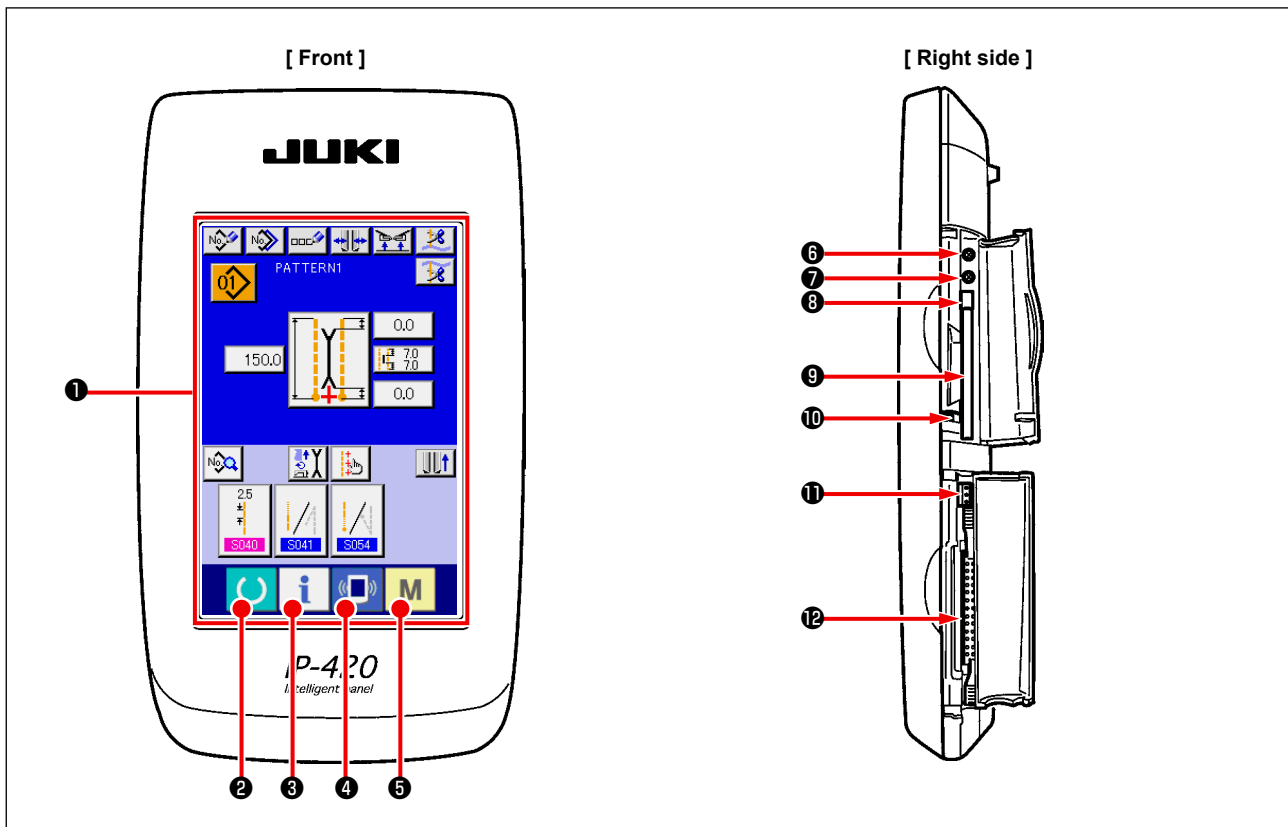
2. BASIC OPERATION OF THE OPERATION PANEL (IP-420)

(1) Configuration of IP-420









Symbol	Name	Description
①	TOUCH PANEL, LCD display section	
②	 READY key	Change-over of the data input screen and the sewing screen is performed.
③	 INFORMATION key	Change-over of the data input screen and the information screen is performed.
④	 COMMUNICATION key	Change-over of the data input screen and the communication screen is performed.
⑤	 MODE CHANGEOVER key	Change-over of the data input screen and the mode change-over screen which performs various details setting.
⑥	Contrast control	
⑦	Brightness control	
⑧	CompactFlash (TM) eject button	
⑨	CompactFlash (TM) slot	
⑩	Cover detection switch	
⑪	Connector for external switch	
⑫	Connector for control-box connection	



1. Lightly press the target key on the touch panel with a fingertip to operate the IP-420. If you operate with any means other than your fingertip, the IP-420 can malfunction or the glass surface of the touch panel can be scratched or break.
2. When READY key is pressed first after turning ON the power, origin retrieval of the clamp foot is performed. At this time, the clamp foot moves. So, be careful.

(2) Buttons used in common

Buttons that perform common operation in the respective screens of IP-420 are as described below.

Pictograph	Name	Description
	CANCEL button	Pop-up screen is closed. In case of the data change screen, the data during changing can be cancelled.
	ENTER button	Data changed are determined.
	UP SCROLL button	This button scrolls button or display upward.
	DOWN SCROLL button	This button scrolls button or display downward.
	RESET button	This button releases error and the like.
	NUMBER INPUT button	Ten keys are displayed and input of number can be performed.
	CHARACTER INPUT button	Character input screen is displayed.

(3) Basic operation

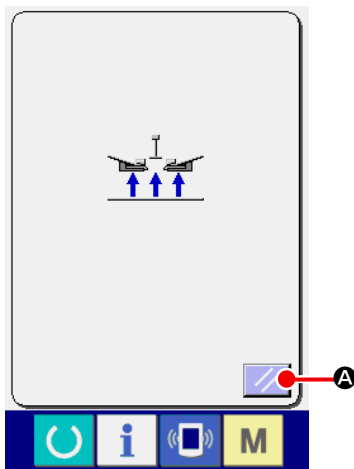

① Turn ON the power switch.

First, turn ON the power switch.

Reset pop-up screen is displayed after displaying WELCOME screen. Press RESET button  **A**.





When RESET button is pressed, the binder goes up. So, be careful.



Next, language selection pop-up screen is displayed. After selecting the language you desire to display, press ENTER button .

B. Then the independent sewing input screen (screen A) of the figure below is displayed.



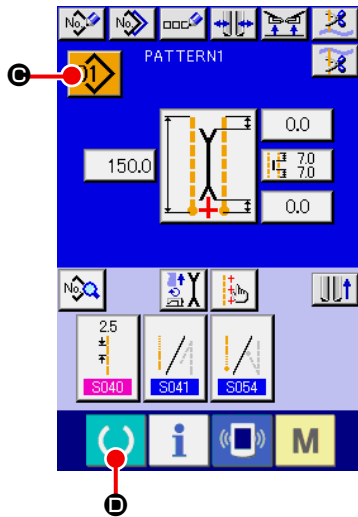

When ending the selection screen with CANCEL button  or ENTER button  without performing the language selection, the language selection screen is displayed whenever the power is turned ON.



The independent sewing input screen (screen A)

② **Select pattern No. you desire to sew.**

When PATTERN NO. button  **C** is pressed, the pattern No. can be selected. For the selecting procedure of pattern No., see **"VI-7.(1) Performing the selection of pattern" p. 42**
At the time of your purchase, pattern Nos. 1 to 10 have been registered. Change the sewing data in accordance with the sewing types for use. (The number to which the pattern has not been registered is not displayed.)

 For the detailed explanation of input screen, see **"VI-3. EXPLANATION OF THE BASIC SCREEN" p. 28 .**

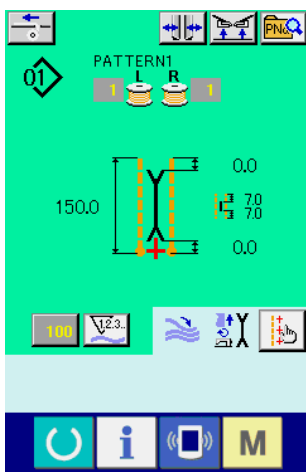

Sewing screen (screen B)

③ **Start sewing**

When READY key  **D** is pressed in the independent sewing input screen (screen A), the green sewing screen (screen B) is displayed and the sewing operation is started by the pedal operation.

 For the detailed explanation of input screen, see **"VI-3. EXPLANATION OF THE BASIC SCREEN" p. 28 .**

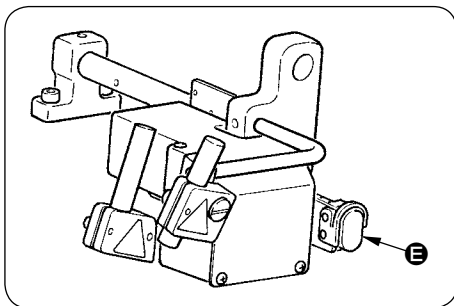

④ **To stop the device during operation**

When temporary stop switch **E** is pressed during sewing, the device can be stopped.

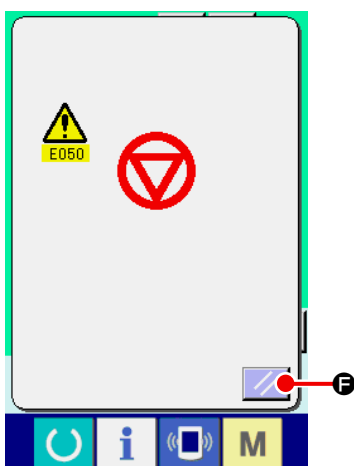

At this time, the error screen is displayed to inform that stop switch is pressed. When RESET button  **F** is pressed, the error is released and the screen returns to the input screen.

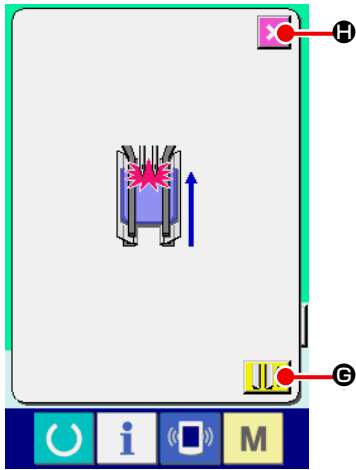



⑤ **Depress back the pedal at the time of selection of the long and wide type.**

At the time of selection of **M004** the long and wide type, when depressing back the pedal in the green sewing screen (screen B), the confirmation screen as shown on the left side is displayed.

When the clamp foot moves to the back by depressing back the pedal, it retreats with the flap presser closed. This screen is to confirm whether material is put on the clamp foot.



Confirming message saying that "Clamp foot moves to the back with flap presser closed. Remove material on the clamp foot" is displayed.

When there is no material on the clamp foot, press CLAMP FOOT BACK button  **G** and the clamp foot moves to the back with the flap presser closed. At the same time, the confirming screen is released and the screen returns to the sewing screen.

When canceling clamp foot back, press CANCEL button 

H, and the flap presser is opened. Then the clamp foot does not move to the back. At the same time, the confirming screen is released and the screen returns to the sewing screen.

When there is material on the clamp foot, be sure to press

 **CANCEL button**  **H** **and remove the material.**

Then depress back the pedal again to move the clamp foot to the back.

3. EXPLANATION OF THE BASIC SCREEN

(1) Input screen (Independent sewing mode)

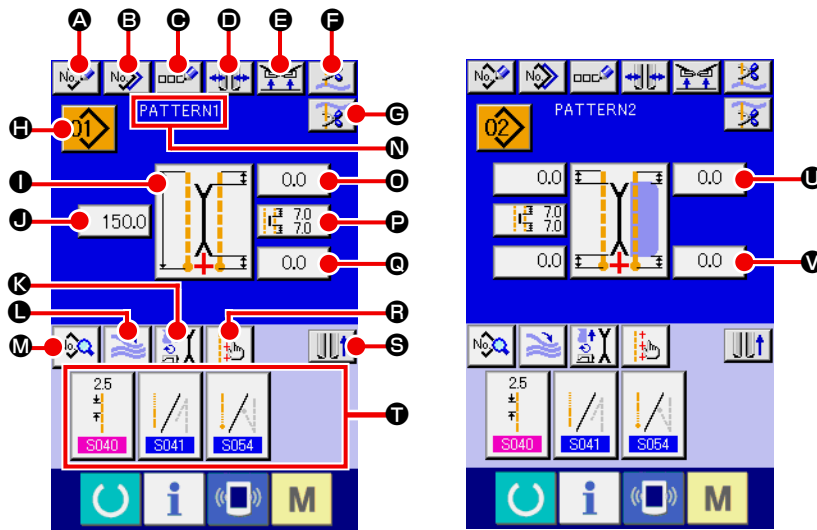

Symbol	Name of button	Description
A	NEW CREATION button	Independent sewing pattern new creation screen is displayed and new register of the pattern data can be performed.
B	COPY button	Independent sewing copy source pattern list screen is displayed and the pattern can be copied.
C	CHARACTER INPUT button	Character input screen is displayed and the name can be inputted to the pattern data.
D	TYPE OF WELT CHANGE-OVER button	Type of welt change-over screen is displayed, and change-over of type of welt and adjustment of parallelism of the binder can be performed.
E	CLAMP UP PROHIBITION AT SEWING END button	When this button is pressed, the clamp is returned in the lowered state at sewing end. It is convenient to use this button at the time of adjusting the marking light or trial sewing.
F	NEEDLE THREAD TRIMMING button	When this button is pressed, needle thread trimming knife comes down and the needle thread trimming operating screen is displayed.
G	BOBBIN THREAD TRIMMING button	Bobbin thread trimming knife opens while this button is pressed.
H	PATTERN NO. LIST button	Pattern No. list screen is displayed and the pattern data can be selected.
I	SEWING MODE CHANGE-OVER button	Sewing mode S003 is selected.
J	L SIZE LENGTH SETTING button	In case of L size sewing, sewing length S004 is set.
K	MOTION MODE SETTING button	With/without S001 of motion of sewing machine motor, center knife and corner knife.
L	STACKER MOTION/STOP CHANGE-OVER button	This button selects motion/stop S069 and S070 of stacker.
M	SEWING DATA DISPLAY button	Sewing pattern edit screen is displayed. Detailed sewing data that are not displayed in the input screen can be selected and edited.
N	PATTERN NAME display	Names that are inputted in pattern Nos. are displayed.
O	CORNER KNIFE MOTION POSITION AT SEWING START SETTING button	Cutting position S019 of corner knife at sewing start is set.
P	CENTER KNIFE SETTING button	Center knife data edit screen is displayed, and center knife cutting position of sewing start S017 and sewing end S018 is set.
Q	CORNER KNIFE MOTION POSITION AT SEWING END SETTING button	Cutting position S020 of corner knife at sewing end is set.
R	MARKING LIGHT SETTING button	Marking light setting screen is displayed. Selection of sewing reference S005 and setting of marking irradiation position, S030 , S031 or S032 is performed.
S	CLAMP FOOT MOVE button	Clamp foot is moved to the front or to the back.
T	SEWING DATA SHORTCUT button	Shortcut buttons (max. 4 items) of the sewing data that are set in customizing in the sewing screen are displayed.
U	FLAP DROP DATA AT SEWING START SETTING button	Flap concealed stitching data at sewing start S008 or S010 is set.
V	FLAP DROP DATA AT SEWING END SETTING button	Flap concealed stitching data at sewing end S009 or S011 is set.

* It is possible to customize display/non-display of the respective buttons.

For the details, refer to "VI-13. CUSTOMIZING THE DATA INPUT SCREEN" p. 75.

(2) Sewing screen (Independent sewing mode)

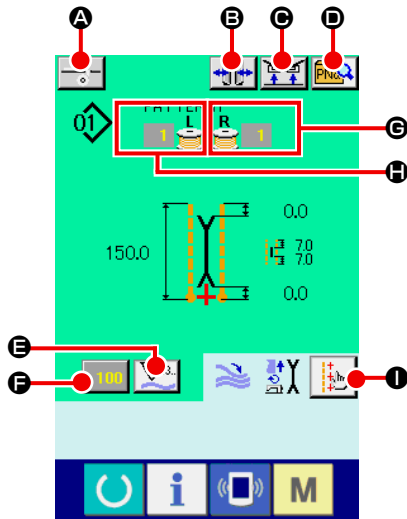

Symbol	Name of button	Description
A	INTERLINING SUPPLY button	When this button is pressed, interlining is supplied. * This is displayed when "With" of SA120 , automatic interlining supplying device is set with the optional setting.
B	TYPE OF WELT CHANGE-OVER button	Type of welt change-over screen is displayed and change-over of type of welt and adjustment of parallelism of the binder can be performed.
C	CLAMP UP PROHIBITION AT SEWING END button	When this button is held pressed, the clamp is returned in the lowered state at sewing end. It is convenient to use this button at the time of adjustment of marking light or trial sewing.
D	DIRECT PATTERN LIST button	Direct pattern list screen is displayed and selection of the sewing data can be performed.
E	COUNTER CHANGE-OVER button	When this button is pressed, the display of sewing counter and number of pcs. counter is changed over. * This button is displayed only when both sewing counter and number of pcs. counter are ON.
F	COUNTER VALUE CHANGE button	This button changes the counter value which is displayed at present.
G	BOBBIN THREAD (RIGHT) REMAINING AMOUNT VALUE	This button detects reflecting light from bobbin and informs that bobbin thread remaining amount is running out. When one stitching completes, the counter value is subtracted, and the count-up screen is displayed when "0" is reached. * This button is displayed only when the reflecting light from bobbin is detected.
H	BOBBIN THREAD (LEFT) REMAINING AMOUNT VALUE	This button detects reflecting light from bobbin and informs that bobbin thread remaining amount is running out. When one stitching completes, the counter value is subtracted and the count-up screen is displayed when "0" is reached. * This button is displayed only when the reflecting light from bobbin is detected.
I	MARKING LIGHT SETTING button	Marking light setting screen is displayed, and changeover of marking light irradiation position S005 and setting of change of marking light set value S030 , S031 and S032 are performed.

* It is possible to customize display/non-display of the respective buttons.

For the details, refer to **"VI-13. CUSTOMIZING THE DATA INPUT SCREEN" p. 75.**

(3) Input screen (Alternate sewing mode)

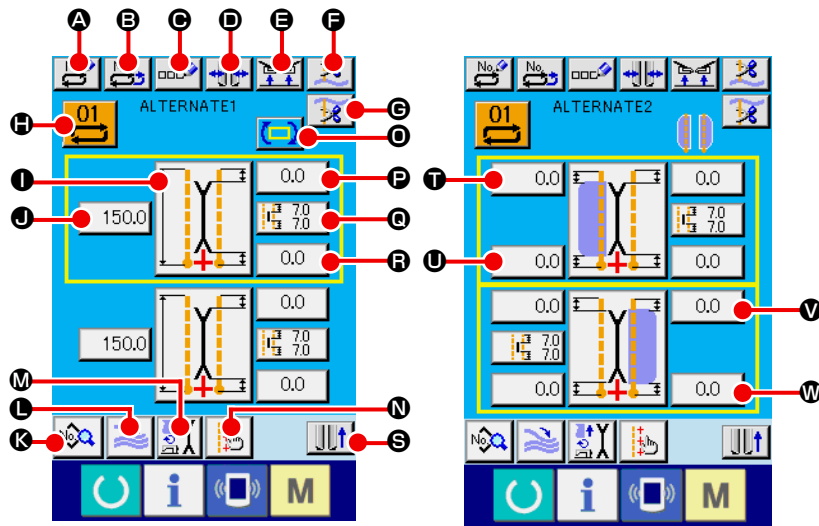

Symbol	Name of button	Description
A	NEW CREATION button	Alternate sewing data new creation screen is displayed and new register of data can be performed.
B	COPY button	Alternate sewing data copy source No. list is displayed and alternate sewing data can be copied.
C	CHARACTER INPUT button	Character input screen is displayed and name input can be performed in the alternate sewing data.
D	TYPE OF WELT CHANGE-OVER button	Type of welt change-over screen is displayed, and change-over of type of welt and adjustment of parallelism of the binder can be performed.
E	CLAMP UP PROHIBITION AT SEWING END button	When this button is held pressed, clamp is returned in the lowered state at the time of sewing end. It is convenient to use this button at the time of adjusting marking light or trial sewing.
F	NEEDLE THREAD TRIMMING button	Needle thread trimming knife comes down and needle thread trimming in motion screen is displayed.
G	BOBBIN THREAD TRIMMING button	Bobbin thread trimming knife opens while this button is pressed.
H	ALTERNATE SEWING DATA NO. LIST button	Alternate sewing data No. list screen is displayed and alternate sewing data can be selected.
I	SEWING MODE CHANGE-OVER button	Sewing mode S003 is selected.
J	L SIZE LENGTH SETTING button	In case of L size sewing, sewing length S004 is set.
K	SEWING DATA DISPLAY button	Sewing pattern edit screen is displayed. This button selects detailed sewing data that are not displayed in the input screen and can edit the data.
L	STACKER MOTION/STOP CHANGE-OVER button	This button selects motion/stop S069 and S070 of stacker.
M	MOTION MODE SETTING button	With/without motion S001 of sewing machine motor, center knife and corner knife.
N	MARKING LIGHT SETTING button	Marking light setting screen is displayed, and selection of sewing reference S005 and setting of marking irradiation position S030 , S031 or S032 can be performed.
O	NEXT SEWING DATA CHANGE-OVER button	Sewing pattern to be sewn next which is enclosed with yellow frame is changed over. * This is not displayed when flap priority sewing selection S002 is ON.
P	CORNER KNIFE MOTION POSITION AT SEWING START SETTING button	Cutting position S019 of corner knife at sewing start is set.
Q	CENTER KNIFE SETTING button	Center knife data edit screen is displayed and center knife cutting position of sewing start S017 and sewing end S018 .
R	CORNER KNIFE MOTION POSITION AT SEWING END SETTING button	Cutting position S020 of corner knife at sewing end is set.
S	CLAMP FOOT MOVE button	Clamp foot is moved to the front or to the back.
T, V	FLAP CONCEALED STITCHING DATA AT SEWING START SETTING button	Flap concealed stitching data at sewing start S008 or S010 is set.
U, W	FLAP CONCEALED STITCHING DATA AT SEWING END SETTING button	Flap concealed stitching data at sewing end S009 or S011 is set.

* It is possible to customize display/non-display of the respective buttons.

For the details, refer to "VI-13. CUSTOMIZING THE DATA INPUT SCREEN" p. 75.

(4) Sewing screen (Alternate sewing mode)

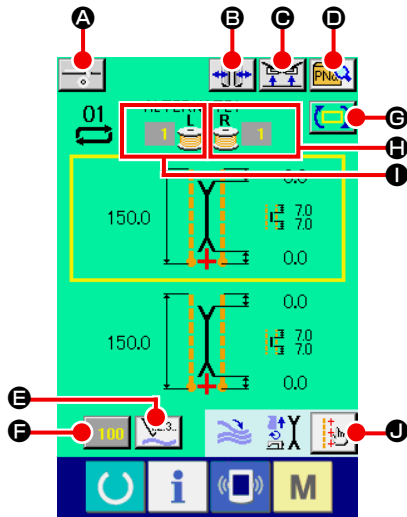

Symbol	Name of button	Description
Ⓐ	INTERLINING SUPPLYING button	When this button is pressed, interlining is supplied. * This is displayed when "With" of S0120 , automatic interlining supplying device is set with the optional setting.
Ⓑ	TYPE OF WELT CHANGE-OVER button	Type of welt change-over screen is displayed, and change-over of type of welt and adjustment of parallelism of the binder can be performed.
Ⓒ	CLAMP UP PROHIBITION AT SEWING END button	When this button is held pressed, the clamp is returned in the lowered state at the time of sewing end. It is convenient to use this button at the time of adjustment of marking light and trial sewing.
Ⓓ	DIRECT PATTERN LIST button	Direct pattern list screen is displayed and selection of the sewing data can be performed.
Ⓔ	COUNTER CHANGE-OVER button	When this button is pressed, display of sewing counter and number of pcs. counter is changed over. This button is displayed only when both sewing counter and number of pcs. counter are ON.
Ⓕ	COUNTER VALUE CHANGE button	Counter value which is displayed at present is changed.
Ⓖ	NEXT SEWING DATA CHANGE-OVER button	Sewing pattern to be sewn next which is enclosed with yellow frame is changed over. * This is not displayed when flap priority sewing selection S002 is ON.
Ⓗ	BOBBIN THREAD (RIGHT) REMAINING AMOUNT VALUE	This button detects reflecting light from bobbin and informs that bobbin thread remaining amount is running out. When one stitching completes, the counter value is subtracted, and the count-up screen is displayed when "0" is reached. * This button is displayed only when the reflecting light from bobbin is detected.
Ⓘ	BOBBIN THREAD (LEFT) REMAINING AMOUNT VALUE	This button detects reflecting light from bobbin and informs that bobbin thread remaining amount is running out. When one stitching completes, the counter value is subtracted, and the count-up screen is displayed when "0" is reached. * This button is displayed only when the reflecting light from bobbin is detected.
⓵	MARKING LIGHT SETTING button	Marking light setting screen is displayed, and changeover of marking light irradiation position S005 and setting of change of marking light set value S030 , S031 and S032 are performed.

* It is possible to customize display/non-display of the respective buttons.

For the details, refer to "**VI-13. CUSTOMIZING THE DATA INPUT SCREEN**" p. 75.

(5) Input screen (Cycle sewing mode)

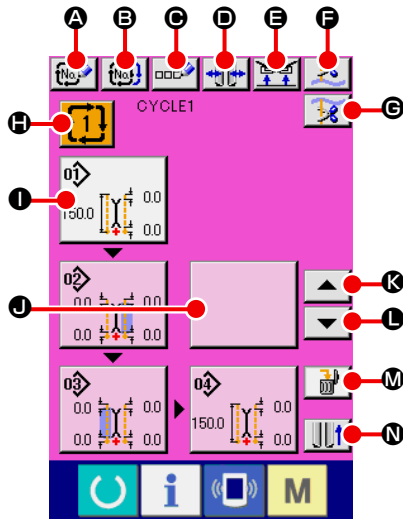

Symbol	Name of button	Description
A	NEW CREATION button	Cycle sewing data No. new creation screen is displayed and new register of cycle sewing data can be performed.
B	COPY button	Cycle sewing data copy source No. list screen is displayed and cycle sewing data can be copied.
C	CHARACTER INPUT button	Character input screen is displayed and name can be inputted to the cycle sewing data.
D	TYPE OF WELT CHANGE-OVER button	Type of welt change-over screen is displayed and change-over of type of welt, and adjustment of parallelism of the binder can be performed.
E	CLAMP UP PROHIBITION AT SEWING END button	When this button is held pressed, the clamp is returned in the lowered state at the time of sewing end. It is convenient to use at the time of adjustment of marking light and trial sewing.
F	NEEDLE THREAD TRIMMING button	Needle thread trimming knife comes down and the needle thread trimming in motion screen is displayed.
G	BOBBIN THREAD TRIMMING button	While this button is held pressed, bobbin thread trimming knife opens.
H	CYCLE SEWING DATA NO. LIST button	Cycle sewing data No. list screen is displayed and the cycle sewing data can be selected.
I	PATTERN DATA EDIT button	Edit of pattern data which have been registered to cycle sewing data can be performed. * For the editing procedure, refer to " 3-(1) Input screen (Independent sewing mode) " p. 28
J	PATTERN DATA EDIT button (blank)	When this blank button is pressed, the pattern list screen to register the pattern data to the cycle sewing data is displayed, and it is possible to select and register the pattern data.
K	CYCLE RETURN button	Pattern data to be sewn next which is displayed with white emphasis is moved forward by one. In case of first pattern, it moves to the last pattern.
L	CYCLE FEED button	Pattern data to be sewn next which is displayed with white emphasis is moved backward by one. In case of the last pattern, it moves to the first pattern.
M	PATTERN DATA DELETION button	Pattern data which is displayed with white emphasis is deleted from register.
N	CLAMP FOOT MOVE button	Clamp foot is moved to the front or to the back.

* It is possible to customize display/non-display of the respective buttons.

For the details, refer to "[VI-13. CUSTOMIZING THE DATA INPUT SCREEN](#)" p. 75.

(6) Sewing screen (Cycle sewing mode)

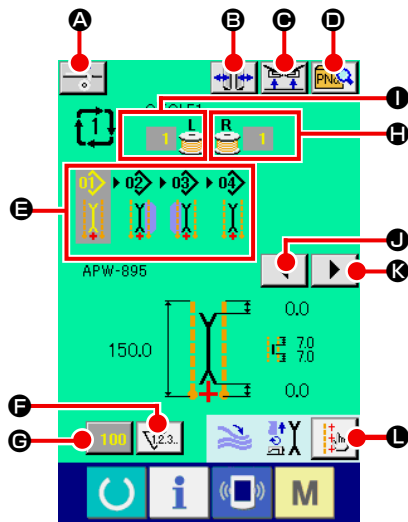

Symbol	Name of button	Description
A	INTERLINING SUPPLYING button	When this button is pressed, interlining is supplied. * This is displayed when "With" of SA120 , automatic interlining supplying device is set with optional setting.
B	TYPE OF WELT CHANGE-OVER button	Type of welt change-over screen is displayed, and change-over of type of welt and adjustment of parallelism of the binder can be performed.
C	CLAMP UP PROHIBITION AT SEWING END button	When this button is held pressed, the clamp is returned in the lowered state at the time of sewing end. It is convenient to use this button at the time of adjustment of marking light and trial sewing.
D	DIRECT PATTERN LIST button	Direct pattern list screen is displayed and selection of the sewing data can be performed.
E	CYCLE DATA display	All pattern data that have been registered to the cycle sewing data are displayed.
F	COUNTER CHANGE-OVER button	When this button is pressed, display of sewing counter and number of pcs. counter is changed over. This button is displayed only when both sewing counter and number of pcs. counter are ON.
G	COUNTER VALUE CHANGE button	Counter value which is displayed at present is changed.
H	BOBBIN THREAD (RIGHT) REMAINING AMOUNT	This button detects light from bobbin and informs that bobbin thread remaining amount is running out. When one stitching completes, the counter value is subtracted, and the counter-up screen is displayed when "0" is reached. * This button is displayed only when the reflecting light from bobbin is detected.
I	BOBBIN THREAD (LEFT) REMAINING AMOUNT	This button detects reflecting light from bobbin and informs that bobbin thread remaining amount is running out. When one stitching completes, the counter value is subtracted, and the counter-up screen is displayed when "0" is reached. * This button is displayed only when the reflecting light from bobbin is detected.
J	LEFT SCROLL button	Pattern data to be sewn next is moved forward by one. In case of the first pattern, it moves to the last pattern.
K	RIGHT SCROLL button	Pattern data to be sewn next is moved backward by one. In case of the last pattern, it moves to the first pattern.
L	MARKING LIGHT SETTING button	Marking light setting screen is displayed, and changeover of marking light irradiation position S005 and setting of change of marking light set value S030 , S031 and S032 are performed.

* It is possible to customize display/non-display of the respective buttons.

For the details, refer to **"VI-13. CUSTOMIZING THE DATA INPUT SCREEN" p. 75.**

4. USING THE COUNTER

(1) Setting procedure of the counter

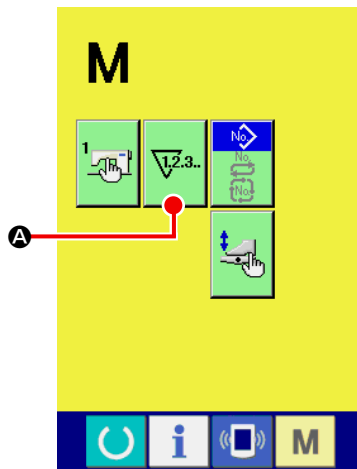

① **Display the counter setting screen.**

Press MODE CHANGEOVER key **M** from the input screen and

COUNTER SETTING button **V2.3.** **A** is displayed on the screen.

Press this button and “COUNTER SETTING screen (screen A)” is displayed.

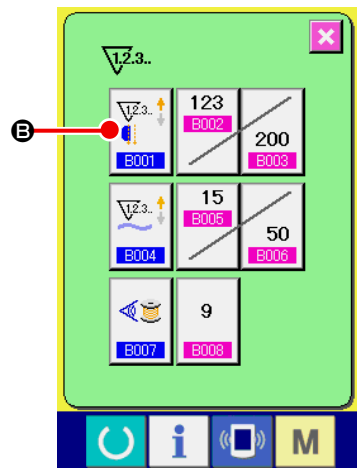

② **Select the kind of counter.**

There are three kinds of counters with this sewing machine, sewing counter, number of pcs. counter and bobbin thread remaining amount adjustment counter.

Press sewing counter button **B** in “counter setting screen

(screen A)”, and “sewing counter setting screen (screen B)” is displayed. Then the kind of counter can be set.

Counter setting screen
(Screen A)

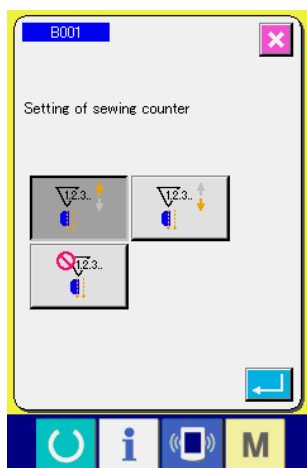

Sewing counter setting
screen (Screen B)

[Sewing counter]	
	UP counter Every time one sewing is performed, the existing value is counter up. When the existing value is equal to the set value, the count-up screen is displayed.
	DOWN counter Every time one sewing is performed, the existing value is counted down. When the existing value is reached to “0”, the count-up screen is displayed.
	Counter unused Sewing counter is set to the prohibition.

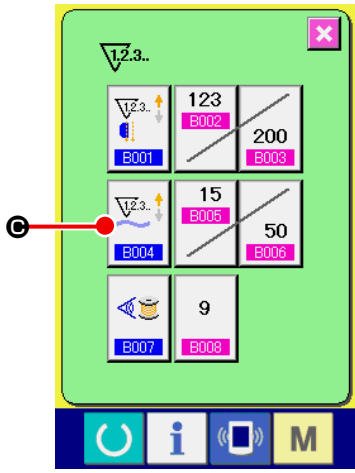

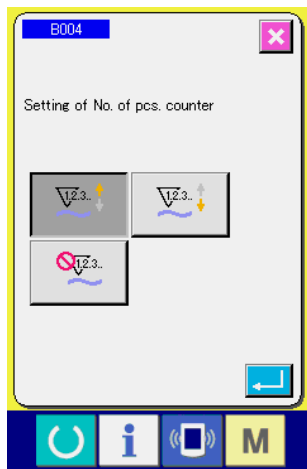

**Counter setting screen
(Screen A)**

Press NUMBER OF PCS. COUNTER button  **C** In “Counter setting screen (screen A)”, and “number of pcs. setting screen (screen C)” is displayed. Then the kind of counter can be set.



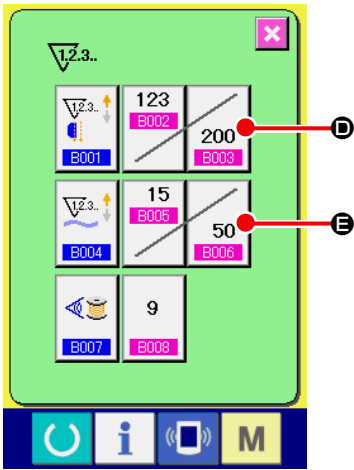

**Number of pcs. counter
(Screen C)**

[Number of pcs. counter]	
	<p>UP counter Every time one of finished products is sewn, the existing value is counted up.</p> <p>* In case of independent sewing : 1 time of sewing In case of alternate sewing : 2 times of sewing In case of cycle sewing : 1 time of cycle sewing</p> <p>The number given in each case above is regarded as one of finished products. When the existing value is equal to the set value, the count-up screen is displayed.</p>
	<p>DOWN counter Every time one of finished products is sewn, the existing value is counted down. When the existing value is reached to “0”, the count-up screen is displayed.</p>
	<p>Counter unused Number of pcs. counter is set to the prohibition.</p>



③ **Changing the target value of the counter**

In case of the sewing counter, press button  **D**, and in case of the number of pcs. counter, press button  **E**, and “ Numerical setting pop-up screen (screen D)” Is displayed. Then the target value of counter can be set.

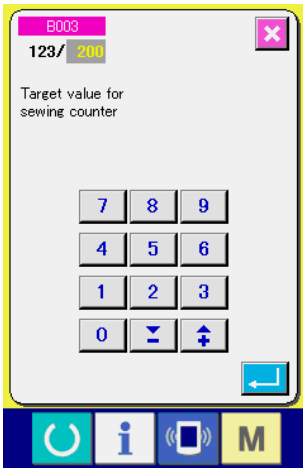

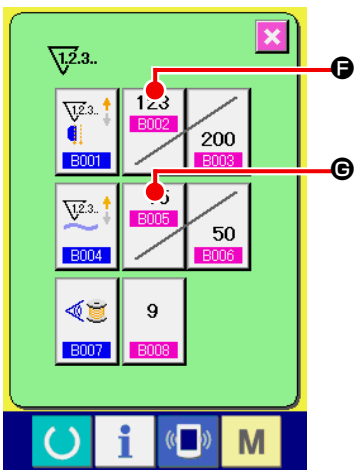

Numerical setting pop-up screen (screen D)

Here, input the target value of counter. When “0” is inputted to the target value of counter, only the existing value is displayed during sewing and the count-up screen is not displayed.



④ **Change the existing value of counter**

In case of the sewing counter, press button  **F** and in case of the number of pcs. counter, press  **G**, and “ Numerical setting pop-up screen (screen E)” is displayed. Then the existing value of counter can be set.

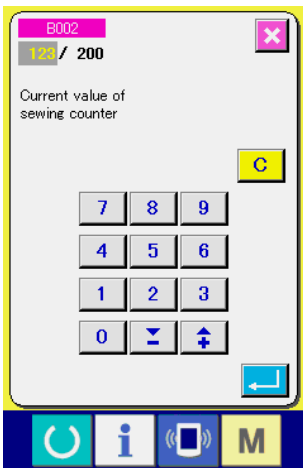

Numerical setting pop-up screen (screen E)

Here, input the existing value of counter.

(2) Releasing procedure of count-up

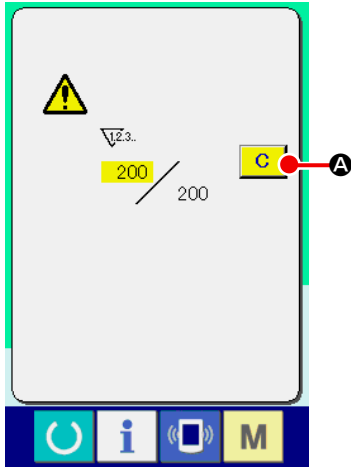

During the sewing work, the count-up condition is reached the count-up screen is displayed and the buzzer sounds. Press CLEAR button **C** **A** to reset the counter, and the screen returns to the sewing screen. And, counting starts again.

(3) Counter value changing procedure during sewing

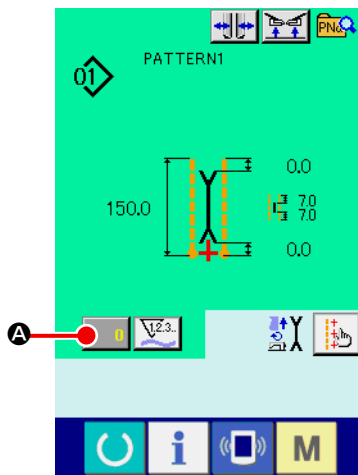

① Display the counter value change screen

When you desire to change the counter value during the sewing work, press COUNTER VALUE CHANGE button **0** **A** on the sewing screen. Counter value change screen is displayed.

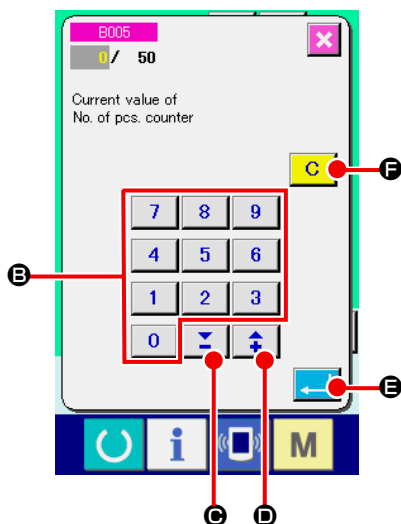

② Change the counter value

Change the counter value with TEN keys **0** to **9** **B** or **▼▲** button **-** **G** (**+** **D**).

③ Determine the counter value

Press ENTER button **↵** **E** and the data is determined. When you desire to clear the counter value, press CLEAR button **C** **F**.

5. USING THE BOBBIN THREAD AMOUNT ADJUSTMENT COUNTER

(1) Setting procedure of the bobbin thread remaining amount adjustment counter

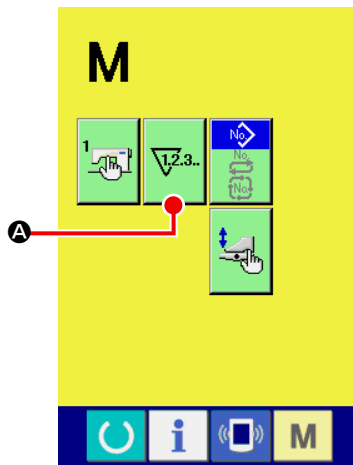

① **Display the counter setting screen**

Press MODE CHANGEOVER key **M** from the input screen,

COUNTER SETTING button **V2.3..** **A** is displayed on the screen..

Press this button and “Counter setting screen (screen A)” is displayed.

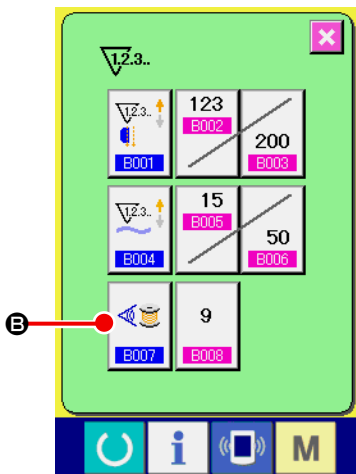

Counter setting screen
(Screen A)

② **Set the bobbin thread remaining amount adjustment counter to ON.**

Press BOBBIN THREAD REMAINING AMOUNT ADJUSTMENT-

COUNTER MOTION SETTING button **E007** **B**, and “Bobbin

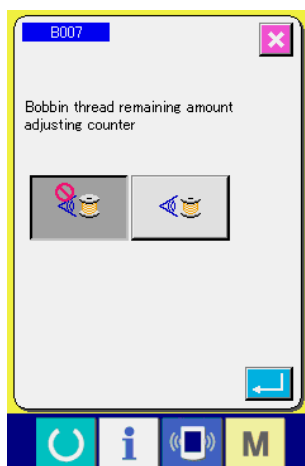

thread remaining amount adjustment counter setting pop-up screen (screen B)” is displayed. Then the bobbin thread remaining amount adjustment counter motion (ON/OFF) can be set.

③ **Set the bobbin thread remaining amount adjustment value**



Bobbin thread remaining amount
adjustment value setting screen
(Screen B)

[Bobbin thread remaining amount detection]

	<p>Bobbin thread remaining amount adjustment counter ON :</p> <p>The counter detects the reflecting light from bobbin and informs that bobbin thread remaining amount is running out. Every time one sewing is performed, the counter value is subtracted and the count-up screen is displayed when the existing value is reached to “0”.</p>
	<p>Bobbin thread remaining amount adjustment counter OFF :</p> <p>Bobbin thread remaining amount detection is set to the prohibition.</p>

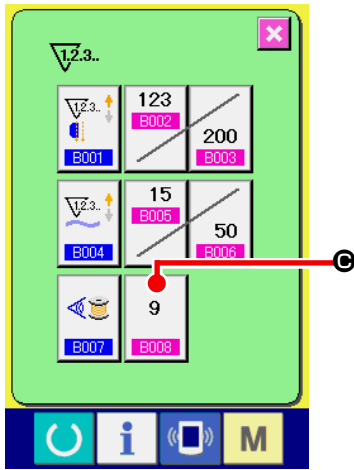

Counter setting screen
(Screen A)

Press BOBBIN THREAD REMAINING AMOUNT ADJUSTMENT VALUE SETTING button  and the bobbin thread remaining amount adjustment value setting screen (screen B) is displayed.

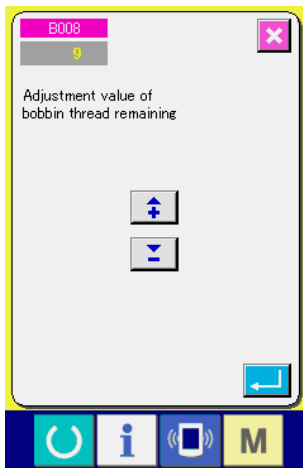

Bobbin thread remaining amount adjustment value setting screen
(Screen B)

Here, input the bobbin thread remaining amount adjustment value (0 to 9).

Set the number of times of sewing from detecting run-out of bobbin thread by the sensor to performing the count-up display.

When you desire to lengthen the remaining length bobbin thread :

 → Decrease the number (toward "0").

When you desire to shorten the remaining length of bobbin thread :

→ Increase the number (toward 9).

*** Setting of the bobbin thread remaining amount adjustment counter ***

- 1) Set the bobbin thread remaining amount adjustment counter to the value shown in the table below.
- 2) Start the sewing to perform regular sewing. In case of test sewing, adjust the sewing length to that to be sewn in the actual process.
- 3) As you continue sewing, the bobbin thread is gradually reduced and the run-out of bobbin thread is displayed in the screen when the bobbin sensor detects the reflecting light.
- 4) At this time, check the length of bobbin thread remaining on the bobbin and properly modify the value on the counter.
- 5) Increasing the counter value by 1 will shorten the remaining length of bobbin thread by the amount that is consumed for one time of sewing.
- 6) The remaining length of bobbin thread at the time when the indication of run-out of bobbin thread varies by a certain extent. This variation depends on the type of thread, sewing length and the winding way of thread.

The remaining length of bobbin thread is shown, as a guide, in the table below. Correct the counter value in accordance with sewing conditions and the like so that the bobbin thread does not completely run out during sewing.

[The table shows the counter value when the sewing length is set to 150 mm]

Thread count	Counter value	Bobbin thread remaining length for reference (m)
#40	1	0.4 to 2.6
#50	2	0.2 to 2.6
#60	2	0.4 to 2.8
#80	3	0.1 to 3.0



- The bobbin thread remaining length has to be re-adjusted in the case described below.
 1. When the sewing length for the sewing product has been changed.
 2. When the thread count of bobbin thread has been changed.
- The value of bobbin thread remaining amount counter is cleared by inputting the value of the bobbin thread remaining amount adjustment counter.

- 7) If the bobbin has run out of thread, the bobbin thread remaining amount detecting device is incapable of performing “bobbin thread remaining amount detection”. So, it is very important to specify a value on the bobbin thread remaining amount adjustment counter to allow the device to give the indication of “run-out of bobbin thread” when the sufficient amount of bobbin thread remains.

(2) Releasing procedure of the bobbin thread remaining amount detection count-up

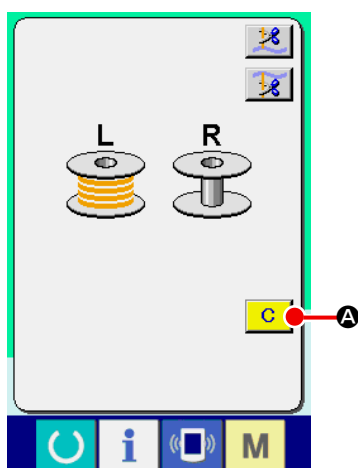

When the bobbin thread remaining amount counter value becomes “0” at the sewing end, the count-up screen is displayed and the buzzer sounds. Replace the bobbin thread of the bobbin where the bobbin thread remains few.

When CLEAR button **C** **A** is pressed, the bobbin thread remaining amount counter value is reset and the screen returns to the sewing screen.

6. CHANGING THE SEWING MODE

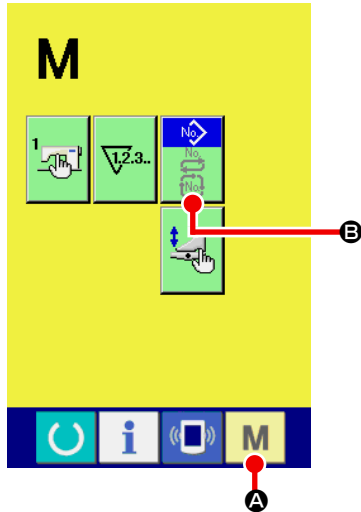

① Display the sewing mode selection screen

Press SEWING MODE CHANGEOVER key **M** **A** and the mode change-over screen is displayed.

② Select the sewing mode

Press MODE SELECTION button **B** and the indication of button is changed.

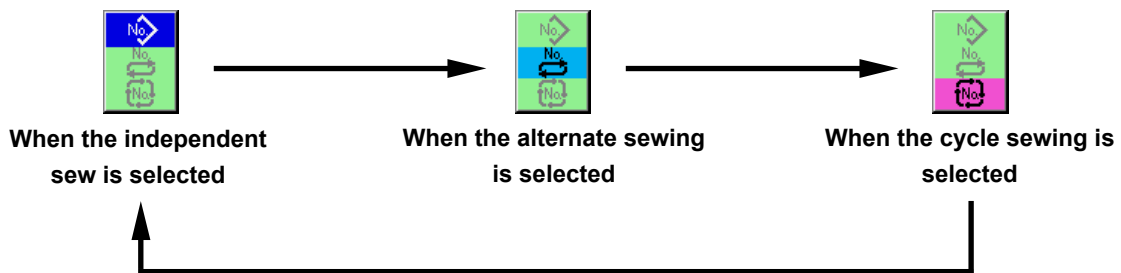

③ Determine the sewing mode.

Press MODE CHANGEOVER key **M** **A** and the data input screen of the selected sewing mode is displayed.

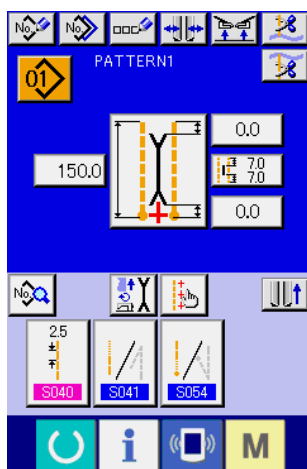

Independent sewing input screen

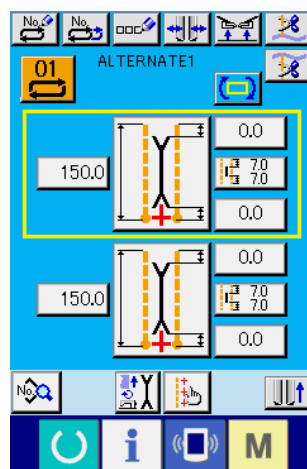

Alternate sewing input screen

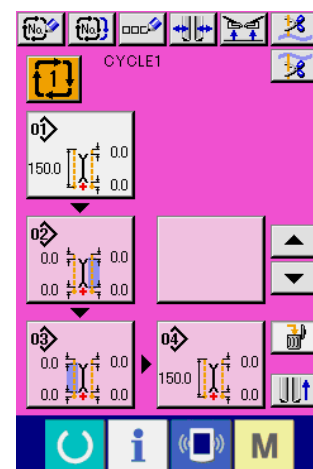

Cycle sewing input screen

7. USING THE SEWING PATTERN

(1) Performing the selection of pattern

① Display the input screen

When the input screen of independent sewing mode, alternate sewing mode and cycle sewing mode is displayed, the selection of pattern can be selected.

By customizing the sewing screen, the selection of pattern can be performed from the sewing screen as well.

② Call the pattern list screen

Press PATTERN LIST button ,  or  (A) and the pattern list screen is displayed.

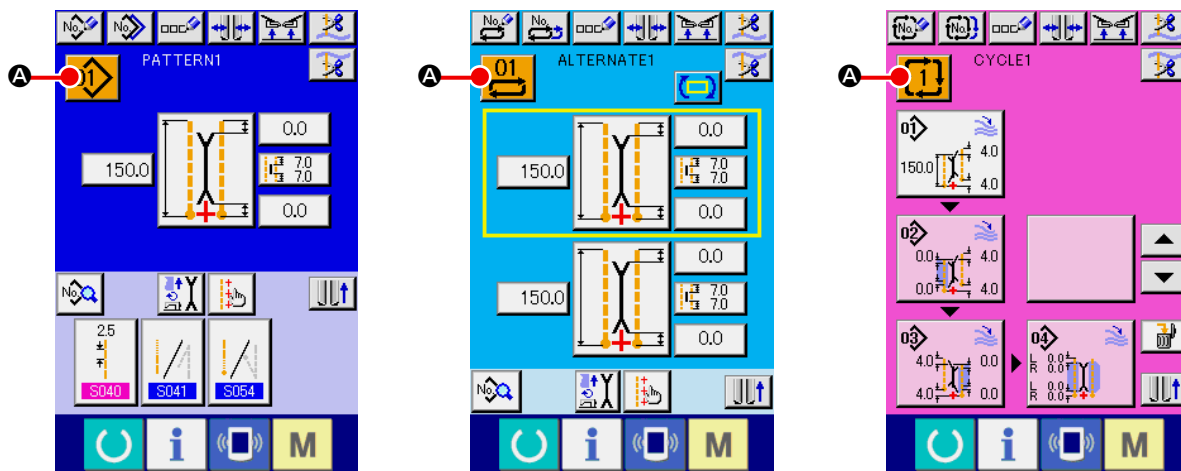

③ Select the pattern

Press pattern data you desire to select (B).

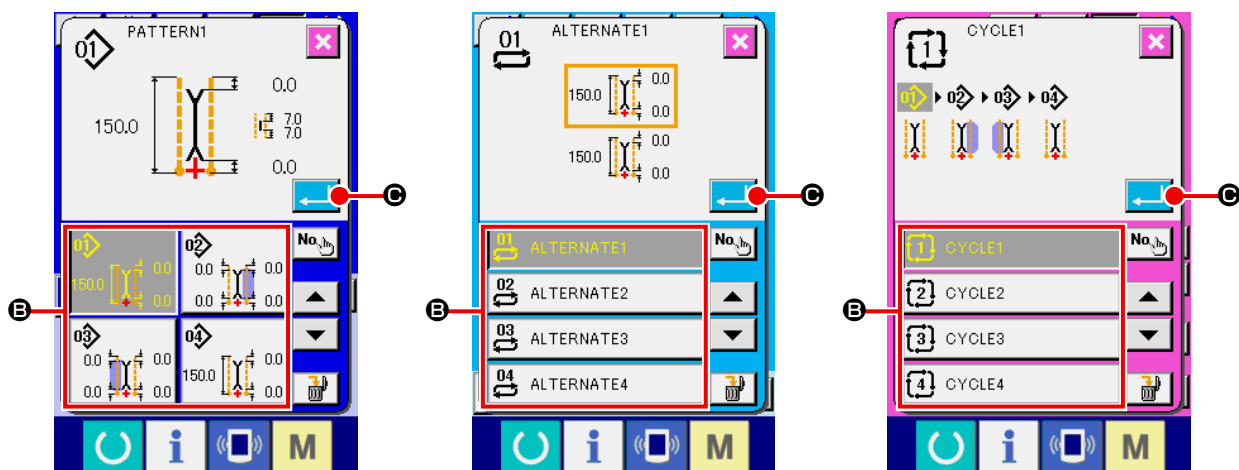

④ Determine the pattern



When ENTER button  (C) is pressed, the pattern is selected and the screen returns to the input screen.

(2) Performing the new creation of pattern

① Display the input screen



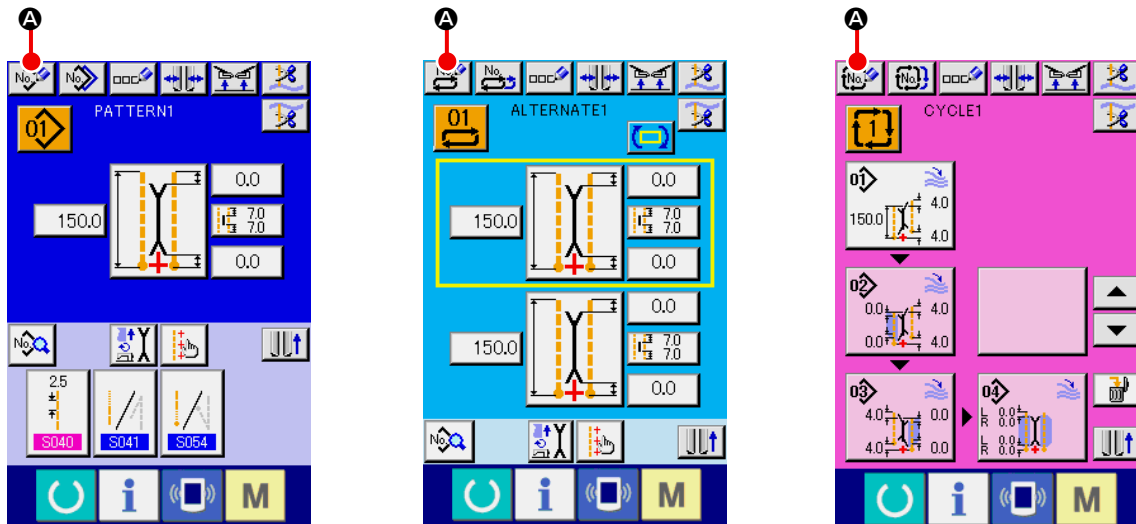

When the input screen of independent sewing mode, alternate sewing mode and cycle sewing mode is displayed, the new creation of pattern can be performed.

② Call the sewing pattern new creation screen

Press NEW CREATION button ,  or  **A**, and the pattern new creation screen is displayed.



③ Input the pattern No.

Input pattern No. you desire to newly create with ten keys  to  **B**. It is possible to retrieve pattern No. which has not been registered yet with  **C** and  **D**.

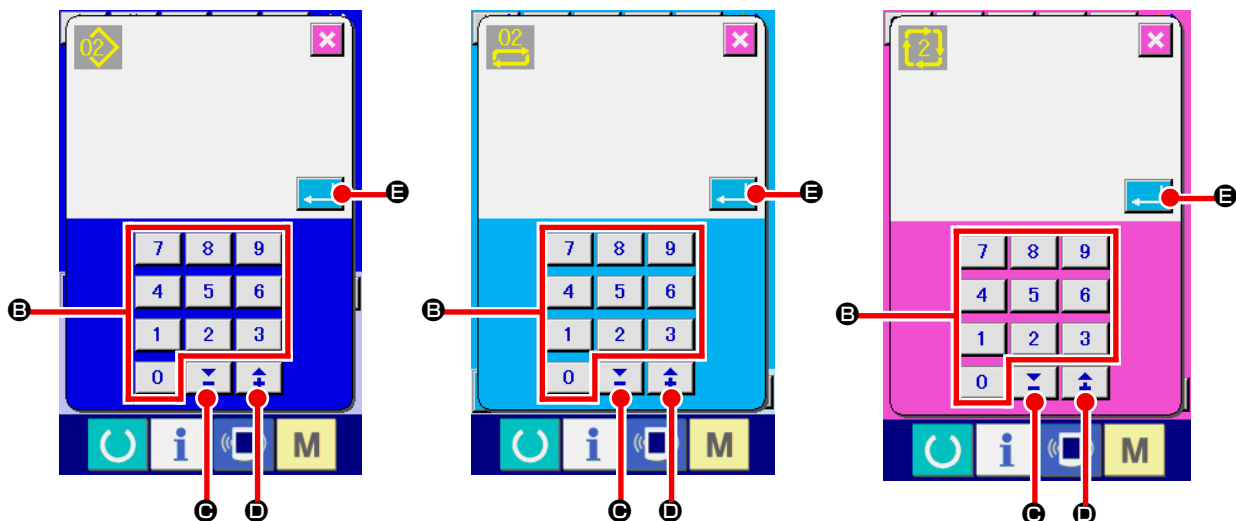

④ Determine the pattern No.

When ENTER button  **E** is pressed, the pattern No. to newly create is determined and the screen returns to the input screen.

(3) Copying the pattern

The pattern which has been already registered can be copied to the sewing pattern which has not registered yet. Copying or overwriting of pattern is prohibited. So, when you desire to overwrite, perform it after erasing the pattern once.

→ For the erasing procedure, see "**VI-7.(4) Erasing the pattern**" p. 46.





When performing copying the pattern No. which has been already registered, copy disapproved error (E401) is displayed.

① Display the input screen

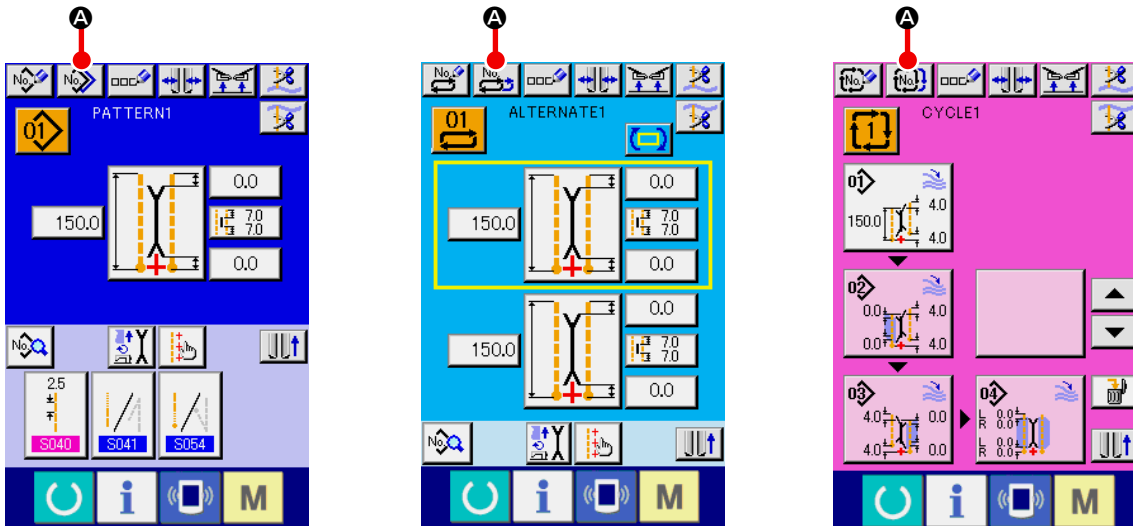
When the input screen of independent sewing mode, alternate sewing mode and the cycle sewing mode is displayed, it is possible to copy.



② Call the pattern No. list screen of the copy source

Press PATTERN COPY button ,  or  **A**, and the copy source pattern list screen is displayed.

③ **Select the pattern of copy source**

Select the pattern of copy source from PATTERN LIST button **B**.

Next, press COPY DESTINATION NO. INPUT button **No.** **C** and the copy destination input screen (screen B) is displayed.

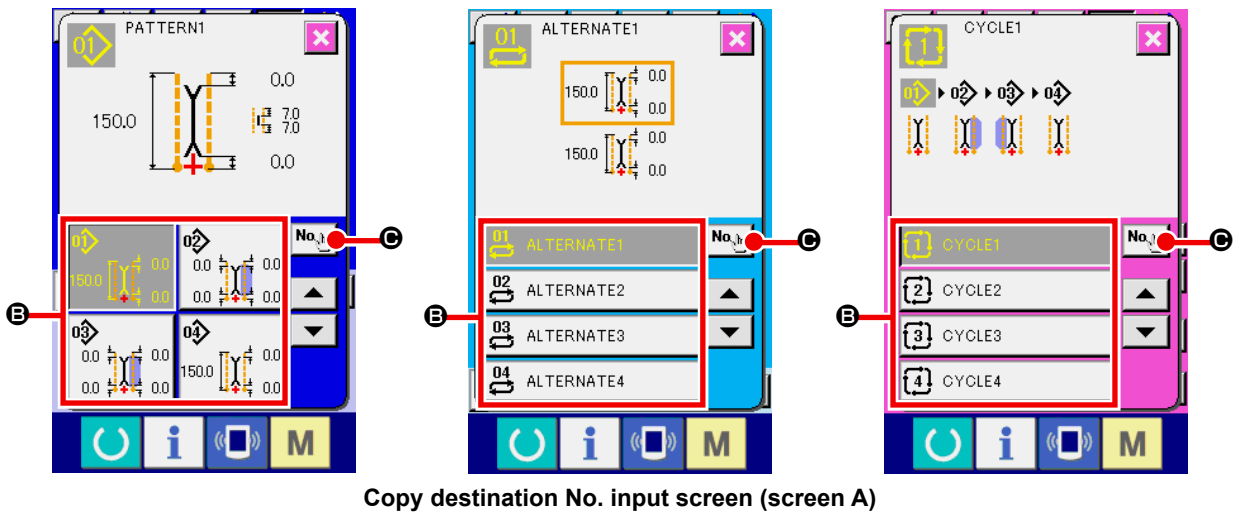

④ **Input the pattern No. of copy destination**

Input the pattern No. of copy destination with ten keys **0** to **9** **B**. It is possible to retrieve the pattern No. which has not been used yet with **▼▲** buttons (**C** and **D**).

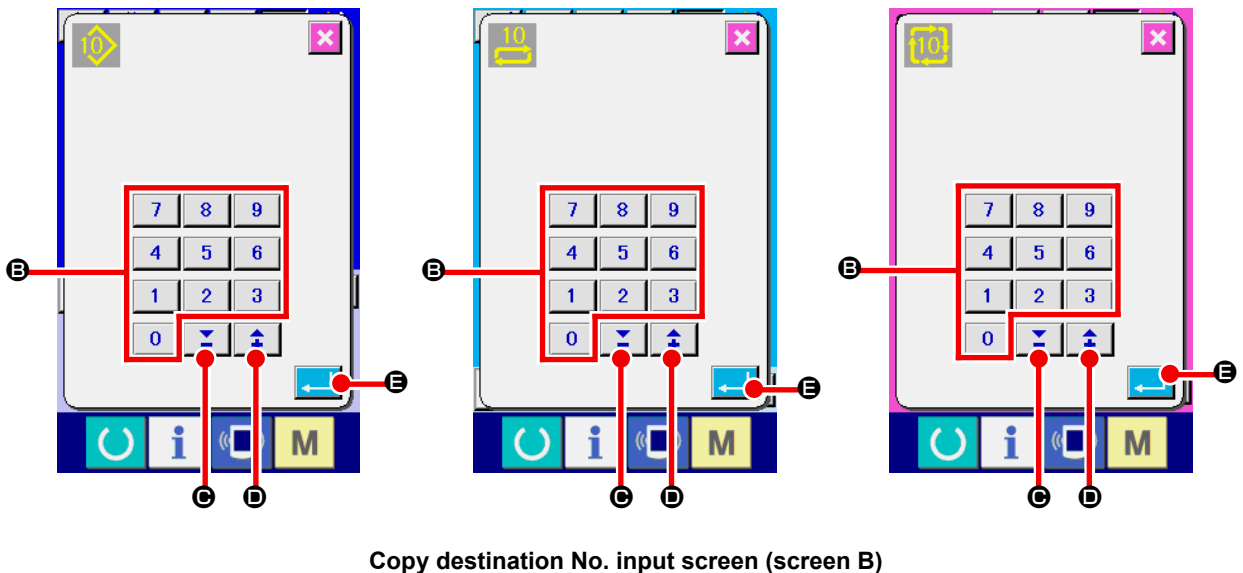

⑤ **Start copying**

When ENTER button **↵** **E** is pressed, copying starts. The pattern No. which has been copied is in the selection state and returns to the copy source pattern list screen (screen A).

(4) Erasing the pattern

① Display the input screen

When the input screen of independent sewing mode, alternate sewing mode and cycle sewing mode is displayed, it is possible to erase the pattern.

② Call the pattern list screen

Press PATTERN LIST button ,  or  **A** and the pattern No. list screen (screen A) is displayed.

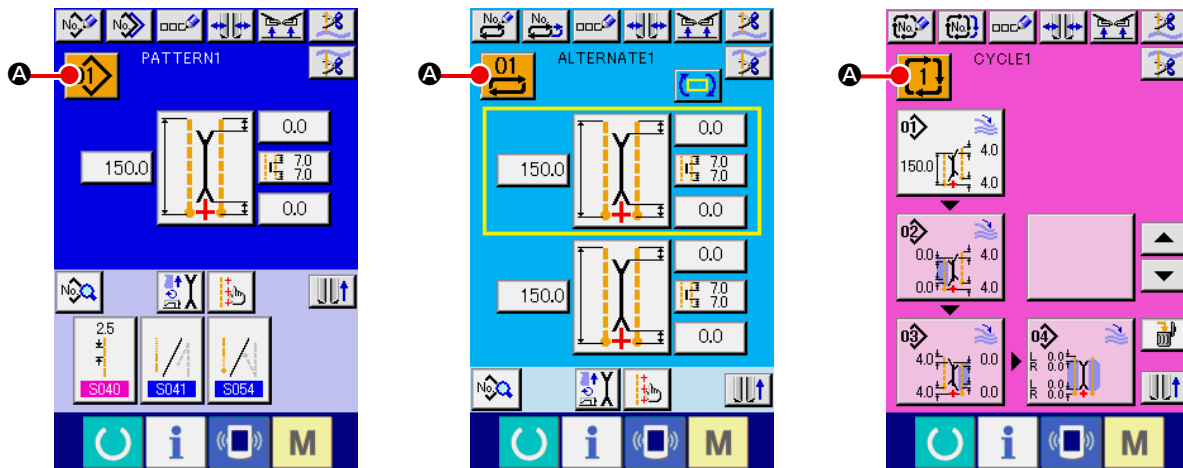

③ Select the pattern to be erased

Select the pattern to be erased from pattern list button **B**.

Next, press ERASE button  **C** and the pattern erase confirmation screen is displayed.

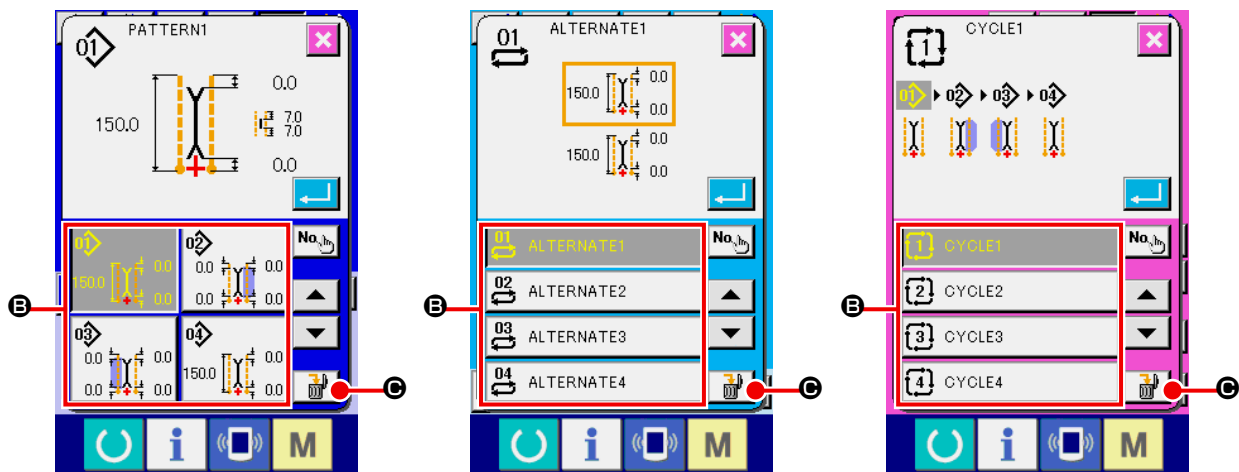

Pattern No. list screen (screen A)

④ Determine the pattern to be erased

Press ENTER button  in the pattern erase confirmation screen and the pattern is erased.

When CANCEL button  is pressed, the screen returns to the original screen A without erasing the pattern.

(5) Naming the pattern

① Display the input screen

When the input screen of independent sewing mode, alternate sewing mode and cycle sewing mode is displayed, it is possible to input the name to the pattern data.

② Call the character input screen

Press CHARACTER INPUT button  **A** and the character input screen (screen B) is displayed.

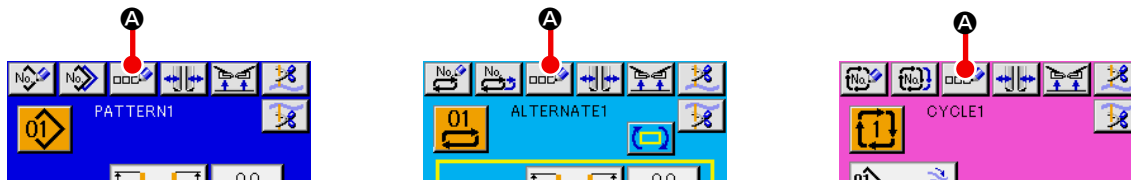

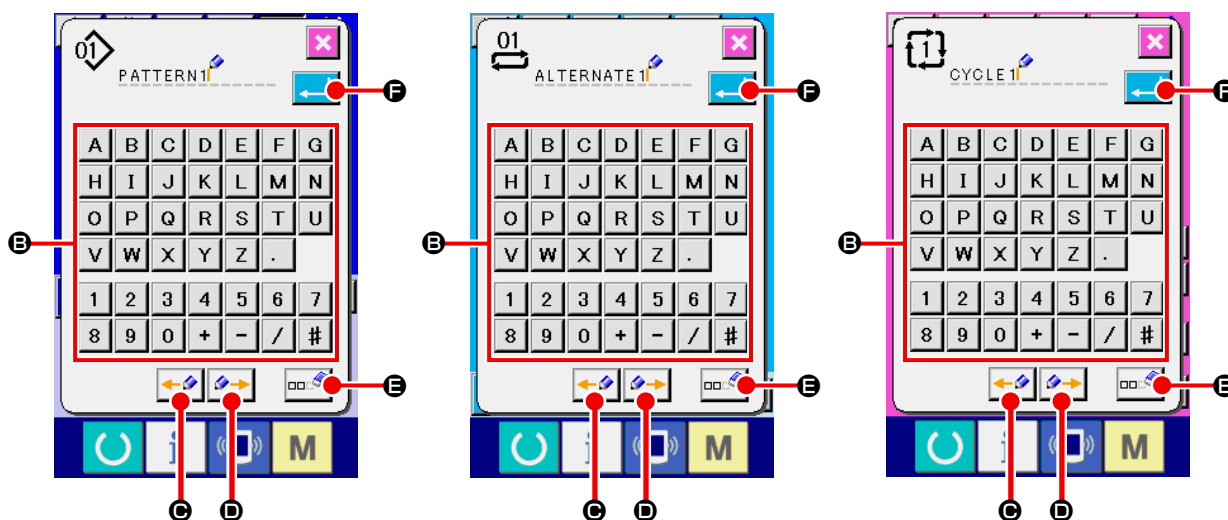

Data input screen (screen A)



Character input screen (screen B)

③ Input the character

It is possible to input the character by pressing CHARACTER button **B** you desire to input. As many as 14 characters of characters (**A** to **Z** and **0** to **9**) and symbols (**+** , **-** , **/** , **#** , **.** and **,**) can be inputted. Cursor can be moved with CURSOR LEFT MOVE button  **C** and CURSOR RIGHT MOVE button  **D**. When you desire to erase the inputted character adjust the cursor to the position of the character you desire to erase and press ERASE button  **E**.

④ End the character input

Press ENTER button  **F** to end the character input. After the end, the inputted character is displayed at the upper part of the input screen.

(6) Editing procedure of the cycle sewing data

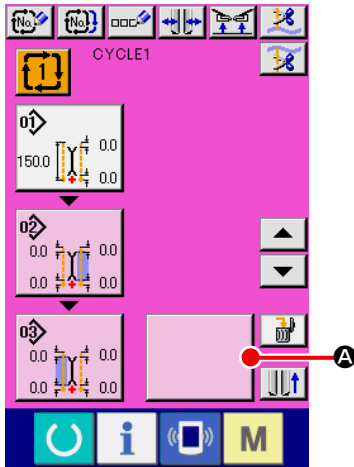

Cycle sewing input screen
(Screen C)

① Display the cycle sewing input screen

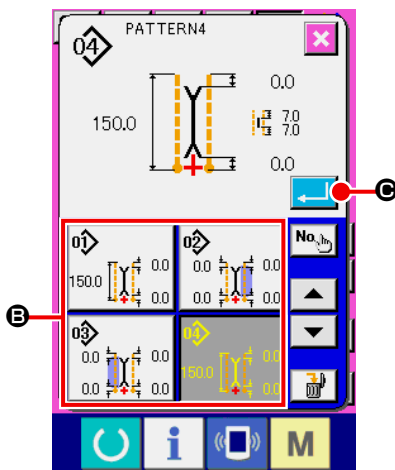

When the input screen of cycle sewing mode is displayed, it is possible to edit the cycle sewing data.



Pattern list screen
(Screen B)

② Register the pattern data

Press BLANK button  and the pattern list screen (screen B) is displayed.

Select the pattern data you desire to register from PATTERN LIST button  and press ENTER button . Then the selected pattern data is registered to the blank section.

When the first pattern data is registered, BLANK button 

 is displayed in the second place. Repeat the operation of ② in case of need.



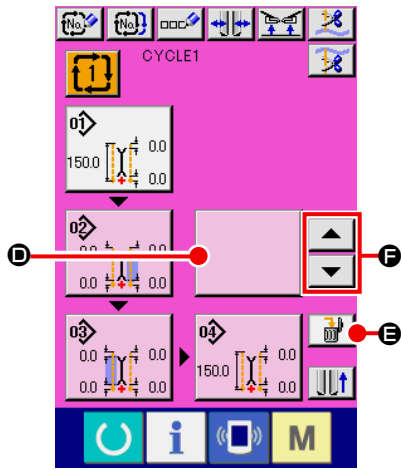

As many as 6 pattern data can be registered to the cycle sewing data.



Cycle sewing input screen
(Screen C)

③ Erase the registered pattern data

Press ERASE button  **E** and the pattern data which is displayed with white emphasis is erased. Select the pattern data you desire to erase with UP/DOWN SCROLL buttons  and  **F** and erase it.



The pattern data which is displayed with white emphasis is the pattern data to be sewn next. So, move it in accordance with the sewing work.

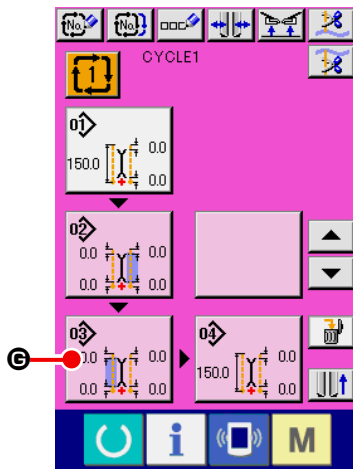

④ Edit the registered pattern data

Press PATTERN DATA button  **G** you desire to edit and the pattern data edit screen (screen D) is displayed in pop-up. Refer to "["VI-3.\(1\) Input screen \(Independent sewing mode\)"](#)" p. 28.

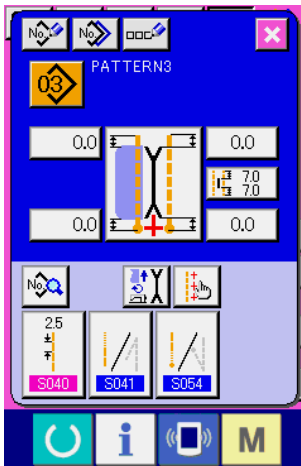

Pattern data edit screen
(Screen D)

8. CHANGING THE SEWING DATA

(1) Changing procedure of the sewing data

① Display the input screen

When the input screen of independent sewing mode, alternate sewing mode and cycle sewing mode is displayed it is possible to change the swing data.

The sewing data which are frequently used can be registered to SEWING DATA SHORTCUT button **B** in the input screen and be set directly. In addition, the detailed sewing data can be set by pressing  **A**.

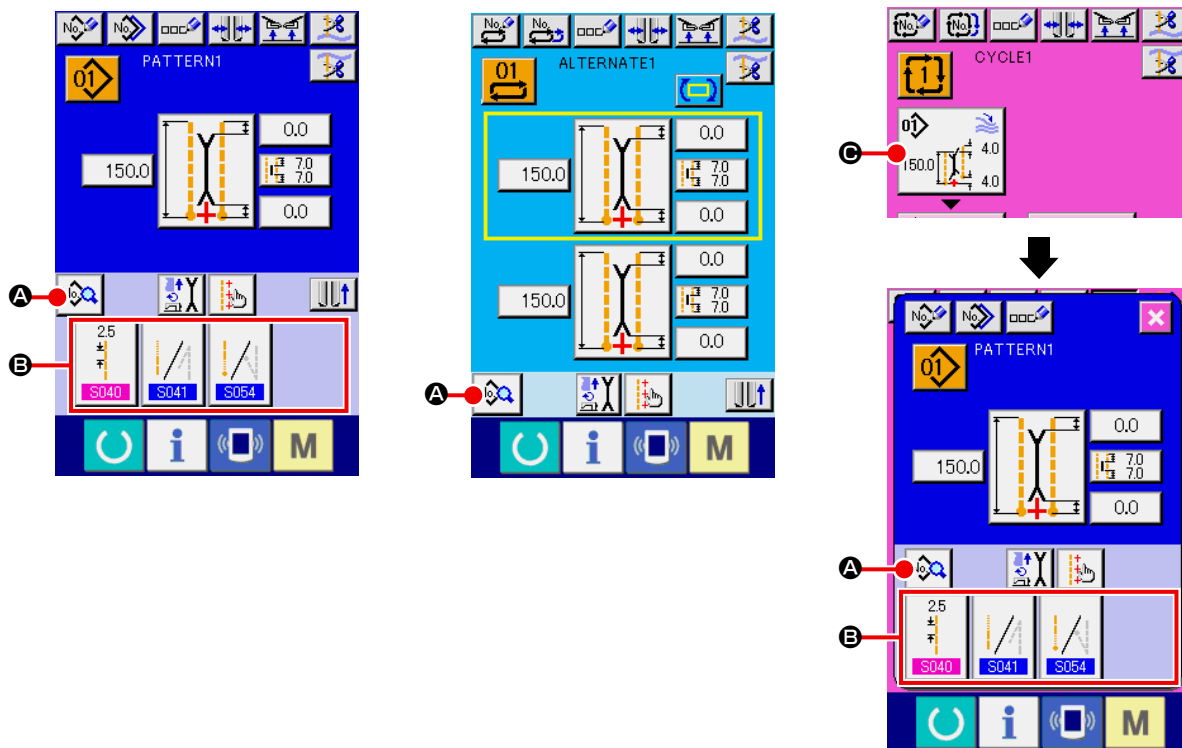

1. When changing the sewing data of cycle sewing mode, press PATTERN DATA EDIT button **C** and it is possible to change.
2. In case of alternate sewing mode, SEWING DATA SHORTCUT button **B** is not displayed.
3. For SEWING DATA SHORTCUT button **B**, refer to "VI-13. CUSTOMIZING THE DATA INPUT SCREEN" p. 75.
4. For the details of sewing data, refer to "① Items that are displayed in the data input screen of VI-8-(2) Sewing data list" p. 51.

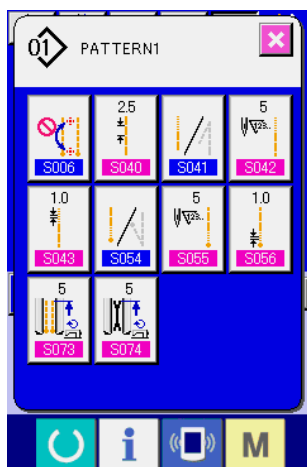

Sewing data list screen (Screen A)

② Select the sewing data to be changed



















Press  **A** and the sewing data list screen (screen A) is displayed. Then select the data you desire to change.

















Caution Data items which are not used due to the shape are not displayed. So, be careful.

(2) Sewing data list

① Items that are displayed in the data input screen















No.	Item	Setting range / Edit unit	Initial value
S001	<p>Motion mode change-over With/without of motion of sewing machine motor, center knife and corner knife is selected.</p>  Cloth feed mode  Cloth feed, sewing machine thread trimming and center knife mode  Cloth feed, sewing machine thread trimming  Cloth feed, sewing machine thread trimming, center knife and corner knife mode	---	
S003	<p>Sewing mode change-over Sewing mode is selected. * In case of alternate sewing, flap priority sewing is set with S002 .</p>  L size sewing  Left flap sewing  Right flap sewing  Flap priority sewing	---	
S004	<p>L size setting In case of L size sewing, the sewing length is set. * It is possible to set only when setting L size sewing S003 . * For the long and wide type, it is possible to set up to 250 mm. (However, it is possible to set up to 300 mm without corner knife.)</p> 	18.0 to 220.0 / 0.1mm	150.0mm
S005	<p>Marking light irradiation position change-over Sewing start irradiation/sewing end irradiation/center irradiation is selected.</p>  Sewing start irradiation  Sewing end irradiation  Center irradiation	---	
S008	<p>Flap concealed stitching data (Left sewing start) Position of sewing start of left-hand flap is adjusted. * It is possible to set only when S003 is set to flap sewing.</p> 	-9.9 to 9.9 / 0.1mm	0.0mm
S009	<p>Flap concealed stitching data (Left sewing end) Position of sewing end of left-hand flap is adjusted. * It is possible to set only when S003 is set to flap sewing.</p> 	-9.9 to 9.9 / 0.1mm	0.0mm
S010	<p>Flap concealed stitching data (Right sewing start) Position of sewing start of right-hand flap is adjusted. * It is possible to set only when S003 is set to flap sewing.</p> 	-9.9 to 9.9 / 0.1mm	0.0mm

 ... Item that is not displayed due to other setting state







No.	Item	Setting range / Edit unit	Initial value
S011	Flap concealed stitching data (Right sewing end) Position of sewing end of right-hand flap is adjusted. * It is possible to set only when S003 is set to flap sewing. 	-9.9 to 9.9 / 0.1mm	0.0mm
S017 S018	Center knife actuating position setting Cutting position of center knife at sewing start/sewing end is set. * Be sure to adjust with every gauge so that the position meets the top of letter V of corner knife.  Sewing start center knife position  Sewing end center knife position	0.0 to 25.0 / 0.1mm * APW-895L only Max. 30.0	7.0mm
S019	Corner knife actuating position at sewing start Cutting position of corner knife at sewing start is set. 	-9.9 to 9.9 / 0.1mm	0.0mm
S020	Corner knife actuating position at sewing end Cutting position of corner knife at sewing end is set. 	-9.9 to 9.9 / 0.1mm	0.0mm
S030 S031 S032	Marking light setting Marking light irradiation position in each case of sewing start irradiation/ sewing end irradiation/center irradiation is set. When set value 0.0n mm, the sewing position is the same as the marking light irradiation position. Use this function when irradiating the marking light to the position that is different from the sewing position.  Sewing start irradiation  Sewing end irradiation  Center irradiation	-100.0 to 100.0 / 0.1mm * Sewing start irradiation : -80.0 to 100.0	0.0mm
S069	Roller stacker stop/motion change-over Stop/motion of roller stacker is selected. * It is displayed only when SP047 is set to roller stacker mounting.  Stop  Motion	---	
S070	Clamp bar stacker stop/motion change-over Stop/motion of clamp bar stacker is selected. * It is displayed only when SP046 is set to clamp bar stacker mounting.  Stop  Motion	---	

 ... Item that is not displayed due to other setting state











② Items that are displayed in the sewing data list screen

No.	Item	Setting range / Edit unit	Initial value
S002	<p>Flap priority sewing selection Flap priority sewing mode is selected. * It is possible to set only when alternate sewing mode is set.</p>  Flap priority sewing prohibited  Flap priority sewing mode	---	
S006	<p>Selection of automatic changeover of marking light irradiation position When S005 is sewing start irradiation or sewing end irradiation, the marking irradiation position is automatically changed over after end of sewing. * This function does not move at the time of alternate sewing mode and cycle sewing mode.</p>  Stop  Motion	---	
S012	<p>Flap forced stop data When flap sewing end is not detected, the machine stops after sewing as long as the set length from rear reference position. * It is possible to set only when S003 is set to flap sewing.</p> 	0.0 to 10.0 / 0.1mm	5.0mm
S040	<p>Lockstitch pitch Sewing pitch of lockstitch section is set.</p> 	2.0 to 3.4 / 0.1mm	2.5mm
S041	<p>Selection of condensation/back tack at sewing start Condensation/back tack at sewing start is selected.</p>  Condensation  Back tack	---	
S042	<p>Number of condensation stitches at sewing start Number of condensation stitches at sewing start is set. * It is possible to set only when S041 is set to selection of condensation.</p> 	3 to 19 / 1 stitch	5 stitches
S043	<p>Condensation pitch at sewing start Condensation sewing pitch at sewing start is set. * It is possible to set only when S041 is set to selection of condensation.</p> 	0.5 to 1.5 / 0.1mm	1.0mm
S044	<p>First stitch pitch of condensation sewing at sewing start First stitch pitch of condensation sewing at sewing start is set. * It is possible to set only when S041 is set to selection of condensation. * It is possible to set only when U024 is set to selection of condensation/back tack detailed setting.</p> 	0.1 to 1.5 / 0.1mm	1.0mm







 ... Item that is not displayed due to other setting state

No.	Item	Setting range / Edit unit	Initial value
S045	<p>Second stitch pitch of condensation sewing at sewing start</p> <p>Second stitch pitch of condensation sewing at sewing start is set.</p> <p>* It is possible to set only when S041 is set to selection of condensation.</p> <p>* It is possible to set only when U024 is set to selection of condensation/back tack detailed setting.</p> 	0.1 to 1.5 / 0.1mm	1.0mm
S046	<p>Third stitch pitch of condensation sewing at sewing start</p> <p>Third stitch pitch of condensation sewing at sewing start is set.</p> <p>* It is possible to set only when S041 is set to selection of condensation.</p> <p>* It is possible to set only when U024 is set to selection of condensation/back tack detailed setting.</p> 	0.1 to 1.5 / 0.1mm	1.0mm
S047	<p>Number of back tack stitches at sewing start</p> <p>Number of back tack stitches at sewing start is set.</p> <p>* It is possible to set only when S041 is set to selection of back tack.</p> 	1 to 12 / 1 stitch	3 stitches
S048	<p>Back tack pitch at sewing start</p> <p>Back tack sewing pitch at sewing start is set.</p> <p>* It is possible to set only when S041 is set to selection of back tack.</p> 	0.5 to 3.0 / 0.1mm	2.0mm
S049	<p>Back tack tie stitch pitch at sewing start</p> <p>Back tack tie stitch at sewing start is set.</p> <p>* It is possible to set only when S041 is set to selection of back tack.</p> 	-2.0 to 2.0 / 0.1mm	-1.5mm
S050	<p>First stitch pitch of return of back tack at sewing start</p> <p>First stitch pitch of return section of back tack sewing at sewing start is set.</p> <p>* It is possible to set only when S041 is set to selection of back tack.</p> <p>* It is possible to set only when U024 is set to selection of condensation/back tack detailed setting.</p> 	0.1 to 3.0 / 0.1mm	2.0mm
S051	<p>Second stitch pitch of return of back tack at sewing start</p> <p>Second stitch pitch of return section of back tack sewing at sewing start is set.</p> <p>* It is possible to set only when S041 is set to selection of back tack.</p> <p>* It is possible to set only when U024 is set to selection of condensation/back tack detailed setting.</p> 	0.1 to 3.0 / 0.1mm	2.0mm









 ... Item that is not displayed due to other setting state

No.	Item	Setting range / Edit unit	Initial value
S052	<p>Third stitch pitch of return of back tack at sewing start</p> <p>Third stitch pitch of return section of back tack sewing at sewing start is set.</p> <p>* It is possible to set only when S041 is set to selection of back tack.</p> <p>* It is possible to set only when U024 is set to selection of condensation/back tack detailed setting.</p> 	0.1 to 3.0 / 0.1mm	2.0mm
S054	<p>Selection of condensation/back tack at sewing end</p> <p>Selection of condensation/back tack at sewing end is performed.</p>  Condensation  Back tack	---	
S055	<p>Back tack pitch at sewing start</p> <p>Back tack sewing pitch at sewing start is set.</p> <p>* It is possible to set only when S054 is set to selection of back tack.</p> 	3 to 19 / 1 stitch	5 stitches
S056	<p>Condensation pitch at sewing end</p> <p>Condensation sewing pitch at sewing end is set.</p> <p>* It is possible to set only when S054 is set to selection of condensation.</p> 	0.5 to 1.5 / 0.1mm	1.0mm
S057	<p>The last stitch pitch of condensation</p> <p>The last stitch pitch of condensation sewing at sewing end is set.</p> <p>* It is possible to set only when S054 is set to selection of condensation.</p> <p>* It is possible to set only when U024 is set to selection of condensation/back tack detailed setting.</p> 	0.1 to 1.5 / 0.1mm	1.0mm
S058	<p>Pitch of one stitch before the last stitch of condensation</p> <p>Pitch of one stitch before the last stitch of condensation sewing at sewing end is set.</p> <p>* It is possible to set only when S054 is set to selection of condensation.</p> <p>* It is possible to set only when U024 is set to selection of condensation/back tack detailed setting.</p> 	0.1 to 1.5 / 0.1mm	1.0mm
S059	<p>Pitch of two stitches before the last stitch of condensation</p> <p>Pitch of two stitches before the last stitch of condensation sewing at sewing end is set.</p> <p>* It is possible to set only when S054 is set to selection of condensation.</p> <p>* It is possible to set only when U024 is set to selection of condensation/back tack detailed setting.</p> 	0.1 to 1.5 / 0.1mm	1.0mm
S060	<p>Number of back tack stitches at sewing end</p> <p>Number of back tack stitches at sewing end is set.</p> <p>* It is possible to set only when S054 is set to selection of back tack.</p> 	1 to 12 / 1 stitch	3 stitches



... Item that is not displayed due to other setting state

No.	Item	Setting range / Edit unit	Initial value
S061	<p>Back tack pitch at sewing end</p> <p>Back tack sewing pitch at sewing end is set.</p> <p>* It is possible to set only when S054 is set to selection of back tack.</p> 	0.5 to 3.0 / 0.1mm	2.0mm
S063	<p>First stitch pitch of return of back tack at sewing end</p> <p>First stitch pitch of return section of back tack sewing at sewing end is set.</p> <p>* It is possible to set only when S054 is set to selection of back tack.</p> <p>* It is possible to set only when U024 is set to selection of condensation/back tack detailed setting.</p> 	0.1 to 3.0 / 0.1mm	2.0mm
S064	<p>Second stitch pitch of return of back tack sewing at sewing end</p> <p>Second stitch pitch of return section of back tack sewing at sewing end is set.</p> <p>* It is possible to set only when S054 is set to selection of back tack.</p> <p>* It is possible to set only when U024 is set to selection of condensation/back tack detailed setting.</p> 	0.1 to 3.0 / 0.1mm	2.0mm
S065	<p>Third stitch pitch of return of back tack sewing at sewing end</p> <p>Third stitch pitch of return section of back tack sewing at sewing end is set.</p> <p>* It is possible to set only when S054 is set to selection of back tack.</p> <p>* It is possible to set only when U024 is set to selection of condensation/back tack detailed setting.</p> 	0.1 to 3.0 / 0.1mm	2.0mm
S067	<p>The last stitch pitch of back tack at sewing end</p> <p>The last stitch pitch of back tack at sewing end is set.</p> <p>* It is possible to set only when S054 is set to selection of back tack.</p> 	-2.0 to 2.0 / 0.1mm	-1.5mm
S068	<p>Compensation of back tack return at sewing end</p> <p>Compensation value of back tack return at sewing end is set.</p> <p>* It is possible to set only when S054 is set to selection of back tack.</p> <p>* It is possible to set only when K061 compensates with pattern data.</p> 	-2.0 to 2.0 / 0.1mm	1.0mm

 ... Item that is not displayed due to other setting state

No.	Item	Setting range / Edit unit	Initial value
S071	<p>Stacking position</p> <p>After moving clamp foot as far as the set distance from the position of corner knife, stacker is actuated. (+ : rear side, - : front side)</p> <p>* Range of actuating amount is limited by the position of clamp foot at the time of sewing end.</p> <p>* Use SP046 clamp bar stacker or SP047 roller stacker. In addition, it is possible to set only when S069 roller stacker motion setting or S070 clamp bar stacker motion setting is performed.</p> 	0 to 500mm / 1mm	0mm
S072	<p>Stacker timer 1</p> <p>Roller rotation time is set. When material sensor has detected without material before setting time, rotation stops.</p> <p>* SP047 roller stacker option is used and it is possible to set only when S069 roller stacker motion is set.</p> 	0.0 to 9.9 / 0.1 sec.	0.5 sec.
S073	<p>Jump feed speed up to the position of sewing start</p> <p>Jump feed speed up to the position of sewing start is set.</p> 	3 to 8 / 1	5
S074	<p>Jump feed speed up to the position of corner knife</p> <p>Jump feed speed up to the position of corner knife is set.</p> 	3 to 6 / 1	5
S075	<p>Dart stretcher device stop/motion change-over</p> <p>Stop/motion of dart stretcher device is selected.</p> <p>* It is possible to set only when SA117 dart stretcher option is used.</p> 	---	
S076	<p>Automatic interlining supplying device stop/motion change-over</p> <p>Stop/motion of automatic interlining supplying device is selected.</p> <p>* It is possible to set only when SA120 automatic interlining supplying option is used.</p> <p>* Regarding the interlining supplying, when the pattern is not used, be careful not to make the interlining come out from the top surface of the table. When using next, press once the feeding button on the panel and perform the feeding motion to cut.</p> 	---	

 ... Item that is not displayed due to other setting state

No.	Item	Setting range / Edit unit	Initial value
S077	<p>Flap length Length of flap is set. It is possible to set only when S076 automatic interlining supplying device is selected to motion and S003 sewing mode changeover is selected to flap sewing. * This setting is set to determine the interlining feeding length of automatic interlining supplying device. Sewing length is determined by the detection of flap sensor.</p> 	37.0 to 220.0 / 0.1mm	150.0mm
S078	<p>Sewing speed under the high-speed mode Number of revolutions at lockstitch section is set. * It is possible to set only when K059 sewing speed setting selection is set to pattern data selection.</p> 	1000 to 3000 / 100sti/min	2500sti/min
S079	<p>Sewing speed under the low-speed mode Number of revolutions at condensation and back tack sewing sections is set. * It is limited by S078 sewing speed under the high-speed mode. * It is possible to set only when K059 sewing speed setting selection is set to the selection of pattern data. * In case of back tack sewing, the upper limit of number of revolutions of the actual low speed is limited to 1,500 sti/min.</p> 	1000 to 2500 / 100sti/min	1500sti/min

 . . . Item that is not displayed due to other setting state

9. CHANGING THE MEMORY SWITCH DATA

(1) Changing procedure of the memory switch data

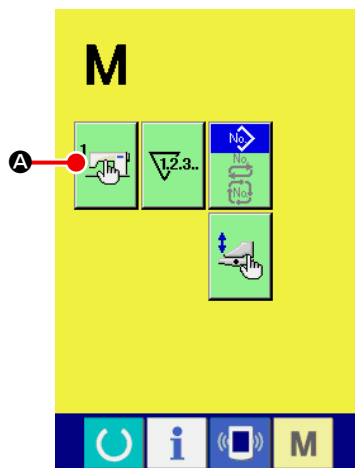

① Display the memory switch data list screen

Press MODE CHANGE-OVER key **M** and the memory switch

button **A** is displayed. When this button is pressed, the memory switch data list (screen A) is displayed.

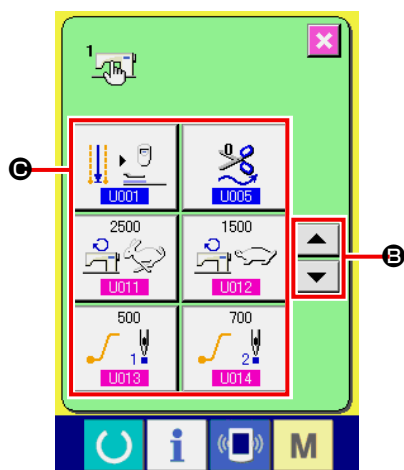

② Select the memory switch button you desire to change







Press UP/DOWN SCROLL button **B** or **B** and select DATA ITEM button **C** you desire to change.

Memory switch data list screen
(Screen A)

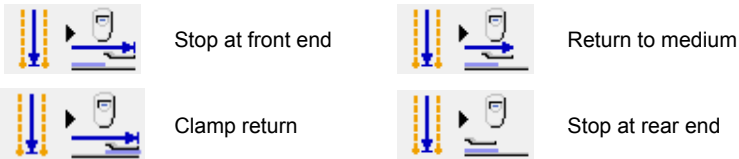
(2) Memory switch data list

① Level 1

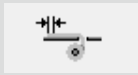
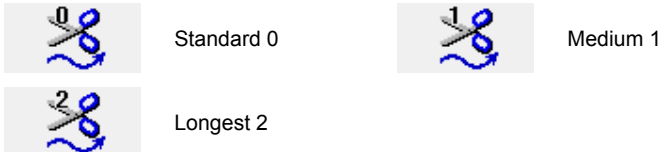



















Memory switch data (level 1) are the motion data that the sewing machine has in common and the data that operate on all sewing patterns in common.

No.	Item	Setting range / Edit unit	Initial value
U001	<p>Change-over of the position of clamp foot after sewing end Position of clamp foot after sewing end is selected from Stop at front end/Return to medium/Clamp return/Stop at rear end.</p> 	---	
U002	<p>Front end motion start waiting time Waiting time up to the start of front end motion of clamp foot is set. * It is possible to set only when U001 is set to the stop at front end.</p> 	0.50 to 9.99 / 0.01 sec.	3.00 sec.
U003	<p>Number of times of feeding of automatic interlining supplying at sewing start Number of times of feeding of automatic interlining supplying device at sewing start is set. * It is possible to set only when SA120 automatic interlining supplying option is used.</p> 	2 to 9 / 1	3
U004	<p>Feeding length of automatic interlining supplying at sewing end Feeding length of automatic interlining supplying device at sewing end is set. * It is possible to set only when SA120 automatic interlining supplying device is used.</p> 	0 to 99.9 / 0.1mm	0mm
U005	<p>Thread trimming timing Thread trimming timing after sewing is selected from Standard/Medium/Longest and length of thread at sewing end is adjusted.</p>  <p>* When SA125 Zipper attachment is mounted and the setting is set to standard value "0", needle thread may not be cut.</p>	---	
U007	<p>Stacker timer 2 Waiting time from the start of clamp motion to hold material on the stacker base to release the material presser is set. * It is possible to set only when SP046 clamp bar stacker option is used.</p>	0.00 to 9.99 / 0.01 sec.	0.70 sec.



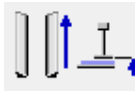





... Item that is not displayed due to other setting state.

No.	Item	Setting range / Edit unit	Initial value
U008	Stacker timer 3 Motion time of material sweeping bar is set. * It is possible to set only when SP046 clamp bar stacker option is used.	0.00 to 9.99 / 0.01 sec.	0.70 sec.
U009	Stacker timer 4 Time to advance timing to release the sewing product by lifting clamp foot is set. When clamping a short sewing product, the amount to drop by tare is adjusted. * It is possible to set only when SP046 clamp bar stacker option is used.	0.00 to 9.99 / 0.01 sec.	0.00 sec.
U011	Sewing speed under the high-speed mode Number of revolutions of lockstitch section is set. * It is possible to set only when K059 sewing speed setting selection is set to memory switch.	1000 to 3000 / 100 sti/min	2500sti/min
U012	Sewing speed under the low-speed mode Number of revolutions of condensation and back tack sewing sections is set. * It is limited by U011 sewing speed under the high-speed mode. * It is possible to set only when K059 sewing speed setting selection is set to memory switch. * In case of back tack sewing, the upper limit of number of revolutions of the actual low speed is limited to 1,500 sti/min.	1000 to 2500 / 100 sti/min	1500sti/min
U013	Soft start, first stitch Number of revolutions of first stitch at sewing start is limited.	500 to 2500 / 100 sti/min	500sti/min
U014	Soft start, second stitch Number of revolutions of second stitch at sewing start is limited.	500 to 2500 / 100 sti/min	700sti/min
U015	Soft start, third stitch Number of revolutions of third stitch at sewing start is limited.	500 to 2500 / 100 sti/min	1000sti/min
U016	Return speed of clamp foot Return speed of clamp foot is set.	3 to 9 / 1	7

 . . . Item that is not displayed due to other setting state.

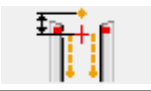
No.	Item	Setting range / Edit unit	Initial value
U017	<p>Thread breakage detection With/without thread breakage detection is selected.</p>  <p>With thread breakage detection</p>  <p>Without thread breakage detection</p>	---	
U018	<p>Flap presser motion mode Motion order of flap presser is selected.</p>  <p>From right</p>  <p>From left</p>  <p>Right/Left at the same time</p>  <p>Side where flap is put</p> <p>* When right and left are simultaneously actuated with customizing of pedal setting, this parameter is neglected and the right and left are simultaneously actuated.</p>	---	
U019	<p>Clamp foot down order change-over Lowering order of clamp foot is selected.</p>  <p>From right</p>  <p>From left</p>  <p>Right/left at the same time</p> <p>* When right and left are simultaneously actuated with customizing of pedal setting, this parameter is neglected and the right and left are simultaneously actuated.</p>	---	
U020	<p>Folding plate motion mode “Return/No return” of folding plate when corner knife projects is selected.</p>  <p>Return</p>  <p>No return</p>	---	
U021	<p>Binder pressure reduction rise prohibition Pressure reduction rise of the binder at the time of jump feed is prohibited.</p>  <p>Pressure reduction rise is prohibited</p>  <p>Pressure reduction rise</p>	---	
U022	<p>Standing pedal continuous depressing timer effective/ineffective change-over Effective/ineffective of U023 standing pedal continuous depressing timer is selected. * It is possible to set only when K054 one-shot pedal is set.</p>  <p>Ineffective</p>  <p>Effective</p>	---	









... Item that is not displayed due to other setting state.

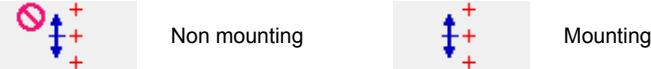

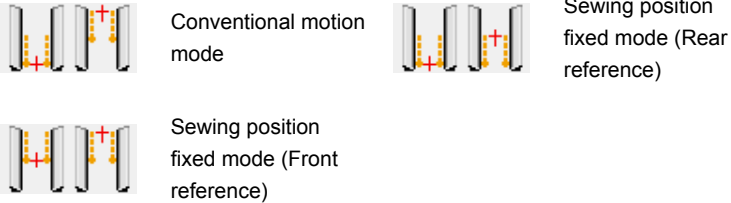

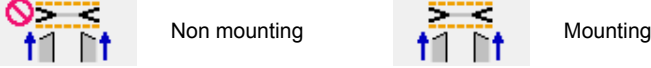







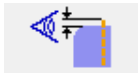
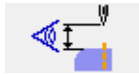
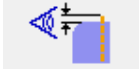

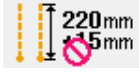
No.	Item	Setting range / Edit unit	Initial value
U023	Standing pedal continuous depressing timer When performing sewing product setting work with the standing pedal depressed, the time interval when the respective devices operate in order is set. * It is possible to set only when K054 one-shot pedal is set. 	0.1 to 2.0 / 0.1 sec.	0.5 sec.
U024	Condensation/back tack detailed setting Detailed setting "Perform/Not perform" of pitch of condensation/back tack section is selected.  Perform  Not perform	---	
U025	Flap stopper position In case of flap sewing, sewing start irradiation position of marking light (distance from needle) is set * Setting is only the irradiation position of marking light. Actual sewing position is the flap end position detected by the flap sensor. 	80.0 to 280.0 / 0.1mm	80.0mm
U028	Stacker timer 5 Sets the waiting time of the stacker from the start of material grasping operation to the release of the material This setting is available when SP048 "Grasping stacker (optional)" is used. 	0.00 - 9.99 / 0.01 sec	1.00 sec
U029	Stacker timer 6 Sets the duration of operating the oscillating arm This setting is available when SP048 "Grasping stacker (optional)" is used. 	0.00 - 9.99 / 0.01 sec	1.50 sec
U245	Number of stitches of grease-up Number of stitches of sewing machine motion after replenishing grease is indicated. * When pressing CLEAR button, number of stitches is cleared to "0". Be sure to clear after replenishing grease. 	---	---
U500	Language selection Language to be indicated in the panel is selected. 日本語 Japanese English English 中文繁體字 Chinese (traditional) 中文简体字 Chinese (simplified) Español Spanish Italiano Italian Français French Deutsch German Português Portuguese Türkçe Turkish Tiếng Việt Vietnamese 한국어 Korean Indonesia Indonesian Русский Russian	---	No selection











 ... Item that is not displayed due to other setting state.



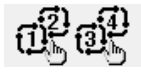
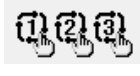

② Level 2

Memory switch data (level 2) are the motion data that the sewing machine has in common and the data that operate on all sewing patterns in common. The data are for the maintenance personnel and possible to edit by pressing the mode switch as long as 6 seconds.

No.	Item	Setting range / Edit unit	Initial value
K051	<p>Marking light mounting Mounting/Non-mounting of marking light is selected. When “Non mounting” is selected, marking light does not work.</p> 	---	
K052	<p>Sewing position selection Mode that surely ends sewing at rear reference position, mode that surely starts sewing from front reference position or the conventional motion mode that changes sewing position according to the setting of S005 is selected.</p> <p>* Front reference position : 80 mm from needle Rear reference position : 300 mm from needle (For the long and wide type, it is 330 mm.) (However, when K058 is set, it is 380 mm.)</p> 	---	
K053	<p>Setting of solenoid valve for corner knife separate drive Mounting/non mounting of solenoid valve for corner knife separate drive is set.</p> 	---	
K054	<p>Pedal operation mode change-over Mode to be used for foot pedal is set.</p> 	---	
K055	<p>Excess rate of center knife cutting Excess rate in terms of the speed of revolution of center knife can be set.</p> 	300 to 500 / 1%	350%

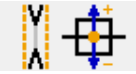
No.	Item	Setting range / Edit unit	Initial value
K056	<p>Setting of intermittent feed prohibition</p> <p>Perform/not perform intermittent feed sewing is selected.</p> <p>* When performing intermittent sewing, the max. sewing speed of sewing machine is limited 1,500 sti/min.</p> <div style="display: flex; justify-content: space-around; align-items: center;"> <div style="text-align: center;">  <p>Perform intermittent feed sewing</p> </div> <div style="text-align: center;">  <p>Not perform intermittent feed sewing</p> </div> </div>	---	
K057	<p>Change-over of flap concealed stitching data edit reference</p> <p>Making the flap concealed stitching data that is set from panel the compensation value from the flap detecting end or the distance from detecting sensor to sewing start is selected.</p> <div style="display: flex; justify-content: space-around; align-items: center;"> <div style="text-align: center;">  <p>Flap detecting end compensation</p> </div> <div style="text-align: center;">  <p>Sensor compensation</p> </div> </div>	---	
K058	<p>L size data range enlargement</p> <p>Enlarging/not enlarging L size data range to max. 220 mm + 15 mm is set. In case of the long and wide type, the size is enlarged to 250 mm + 50 mm.</p> <p>* When performing sewing longer than 250 mm with M004 the long and wide type, the corner knife does not work.</p> <p>* In case of M004 the long and wide type, corner knife does not work when a flap cloth is put in the area of +50 mm even when it is less than 250 mm.</p> <div style="display: flex; justify-content: space-around; align-items: center;"> <div style="text-align: center;">  <p>Not enlarging</p> </div> <div style="text-align: center;">  <p>Enlarging</p> </div> </div>	---	
K059	<p>Selection of sewing speed of sewing machine setting</p> <p>It is selected that either memory switch or pattern data performs setting of sewing speed of sewing machine.</p> <div style="display: flex; justify-content: space-around; align-items: center;"> <div style="text-align: center;">  <p>Memory switch</p> </div> <div style="text-align: center;">  <p>Pattern data</p> </div> </div>	---	
K060	<p>Selection of reflecting tape check mode</p> <p>ON/OFF of reflecting tape check mode is set.</p> <p>When ON is set, the clamp foot is automatically comes lowered with the first clamp foot advance motion after turning ON the power and deterioration check of reflecting tape is performed.</p> <p>* Clamp foot is automatically lowered. Be sure to use this function only in case of shim type.</p> <div style="display: flex; justify-content: space-around; align-items: center;"> <div style="text-align: center;">  <p>OFF</p> </div> <div style="text-align: center;">  <p>ON</p> </div> </div>	---	
K061	<p>Selection of back tack return at sewing end compensation setting</p> <p>It is selected that either memory switch or pattern data performs setting of back tack return at sewing end compensation.</p> <div style="display: flex; justify-content: space-around; align-items: center;"> <div style="text-align: center;">  <p>Memory switch</p> </div> <div style="text-align: center;">  <p>Pattern data</p> </div> </div>	---	

No.	Item	Setting range / Edit unit	Initial value
K062	<p>Back tack return at sewing end compensation Back tack return at sewing end compensation is set. * It is possible to set only when K061 is set to the memory switch selection.</p> 	-2.0 to 2.0 / 0.1mm	1.0mm
K063	<p>Selection of mode change-over button display in the pattern list screen Mode change-over button is displayed in the pattern list screen and data of different mode can be selected.</p>  Non-display  Display	---	
K066	<p>Cycle sewing coupling function Odd-numbered pattern can be coupled to even-numbered pattern and as many as 12 steps can be sewn. Only combination of 1 and 2, 3 and 4, 5 and 6, 7 and 8, 9 and 10, 11 and 12, 13 and 14, 15 and 16, 17 and 18, and 19 and 20 can be coupled.</p>  Coupling function OFF  Coupling function ON	---	
K069	<p>Center knife lowering time Center knife lowering time is set.</p> 	10 to 100 / 1	40
K070	<p>Center knife one-shot motion prohibition setting With/without one-shot motion to properly cut the cutting position of center knife on the side of the end of sewing is selected.</p>  With one-shot motion  One-shot motion prohibited	---	
K080	<p>Clamp foot motor origin compensation Origin of clamp foot motor is compensated.</p> 	-10.0 to 10.0 / 0.1mm	0.0mm

No.	Item	Setting range / Edit unit	Initial value
K081	<p>Corner knife motor origin compensation Origin of corner knife motor is compensated.</p> 	-5.0 to 5.0 / 0.1mm	0.0mm
K082	<p>Marking light origin compensation (just under) Origin of marking light motor is compensated. Origin is in the state that it irradiates light just under and located at the position of 230 mm from needle. * In case of M004 Long and wide type, light irradiation position is at the position of 246 mm from the needle.</p> 	-500 to 500 / 1 pulse	0 pulse
K083	<p>Marking light origin compensation (needle side) Position of needle side from origin of marking light motor is compensated. Light irradiation position is 80 mm from needle. * In case of M004 Long and wide type, light irradiation position is at the position of 96 mm from the needle.</p> 	-500 to 500 / 1 pulse	0 pulse
K084	<p>Marking light origin compensation (operator side) Position of operator side from origin of marking light motor is compensated. Light irradiation position is 380 mm from needle. * In case of M004 Long and wide type, light irradiation position is at the position of 396 mm from the needle.</p> 	-500 to 500 / 1 pulse	0 pulse
K085	<p>Back tack motor origin compensation Origin of back tack motor is compensated.</p> 	-30 to 30 / 1 pulse	0 pulse

10. PERFORMING OPTIONAL SETTING

(1) Changing procedure of the optional setting

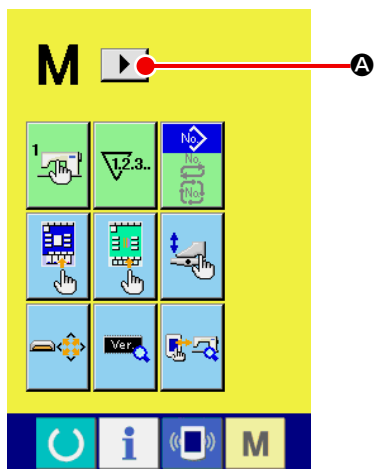

- ① **Displaying the 2nd screen of the operation-mode changeover screen.**

When you keep operation-mode changeover key **M** held pressed for six seconds, right-scroll button **A** is displayed on the screen.

When you press this button, the 2nd screen (screen A) of the operation-mode changeover screen is displayed.

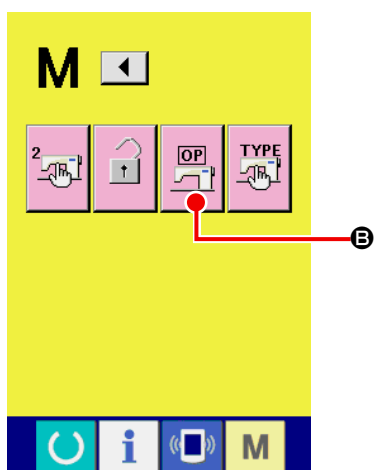

- ② **Displaying the option setting list screen**

Option setting button **B** is displayed on the screen.

When you press this button, option setting list screen (screen B) is displayed.

Second screen of the mode changeover screen (Screen A)

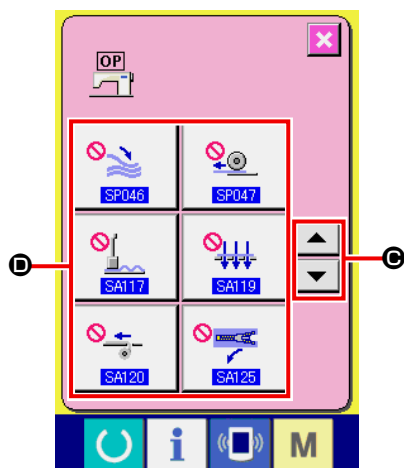



















- ③ **Selecting the option setting you want to change**

Press up/down scroll buttons **C** to select the data item button **D** you want to change.

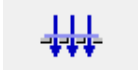
Optional setting list screen (Screen B)

(2) Optional setting list

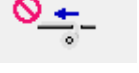
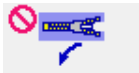
By setting the optional mounted state, it is possible to perform the respective optional operations.

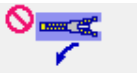
No.	Item	Setting range / Edit unit	Initial value
SP046	Clamp bar stacker mounting/not mounting is set  Not mounting  Mounting	---	 Not mounting
SP047	Roller stacker mounting/not mounting is set.  Not mounting  Mounting	---	 Not mounting
SP048	Sets mount/unmount of the grasping stacker device mount/unmount  Unmount  Mount	---	 Unmount
SA117	Dart stretcher mounting/not mounting is set. * However, in case of dart stretcher mounting, M001 Gauge size setting is limited to 8 to 12 mm. * In case of M004 the long and wide type, the dart stretcher does not work.  Not mounting  Mounting	---	 Not mounting
SA119	Vacuum device mounting/not mounting is set. * In case of M004 the long and wide type, the vacuum device does not work.  Not mounting  Mounting	---	 Not mounting
SA120	Automatic interlining supplying device mounting/not mounting is set. * In case of M004 the long and wide type, the automatic interlining supplying device does not work.  Not mounting  Mounting	---	 Not mounting
SA125	Zipper attachment mounting/not mounting is set. * However, in case of zipper attachment mounting, M001 Gauge size setting is limited to 16 to 20 mm. * In case of M004 the long and wide type, the zipper attachment does not work.  Not mounting  Mounting	---	 Not mounting

11. CHANGING THE DEVICE SETTING

(1) Changing procedure of the device setting



- ① **Displaying the 2nd screen of the operation-mode changeover screen.**

When you keep operation-mode changeover key **M** held pressed for six seconds, right-scroll button  **A** is displayed on the screen.

When you press this button, the 2nd screen (screen A) of the operation-mode changeover screen is displayed.

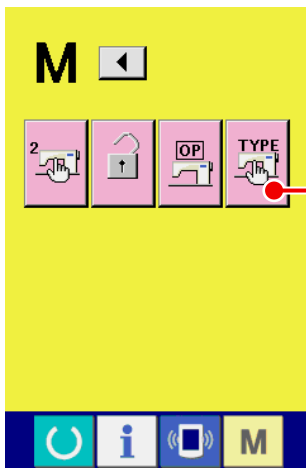

- ② **Displaying the device setting list screen**

Device setting button  **B** is displayed on the screen.

When you press this button, the device setting list screen is displayed.

Second screen of the mode changeover screen (Screen A)

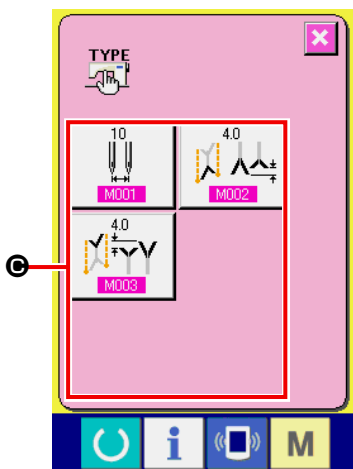



- ③ **Selecting the device setting you want to change**

Select the data item button  **C** you want to change.

Device setting list screen (Screen B)

(2) Device setting list

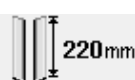
By setting the type of device, it is possible to operate according to the type.

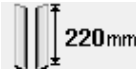
No.	Item	Setting range / Edit unit	Initial value
<p>M001</p>	<p>Gauge size Gauge size of sewing machine is set. * For M004 the long and wide type, the range is enlarged to 22 to 32 mm. * Corner knife motion is changed according to the set value of gauge size. * When SA117 Dart stretcher device is mounted, the range is limited to 8 to 12 mm and SA125 Zipper attachment is mounted, 16 to 20 mm.</p> 	<p>8 to 20 (22 to 32) / 2 mm</p>	<p>10 mm</p>
<p>M004</p>	<p>Long and wide type selection It is set when using the long and wide type.</p>  <p>Standard : Standard clamp mounting, Sewing size 220 mm</p>  <p>Long and wide type : Clamp foot for long and wide type mounting, Sewing size 250 mm</p> <div style="border: 1px dashed black; padding: 5px; margin-top: 10px;">  <p>The type has been set according to the mounted clamp foot type at the time of delivery. Do not select any other than the mounted clamp foot type since interference occurs.</p> </div>	<p>---</p>	

12. CUSTOMIZING THE PEDAL OPERATION

Operation functions of “Binder down”, “Flap presser down”, etc. in terms of the number of the respective depressing steps of the pedal can be optionally registered in accordance with the using conditions. In addition, the customized pedal operation data can have as many as 5 kinds. Select and use them.

(1) Method to select and use the customized data

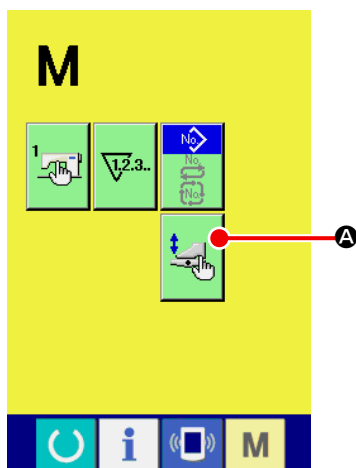

① Display the pedal customizing screen

Press MODE CHANGEOVER key **M** and PEDAL CUSTOMIZ-

ING button **A** is displayed on the screen.

Press this button and the pedal customizing screen (screen A) is displayed.

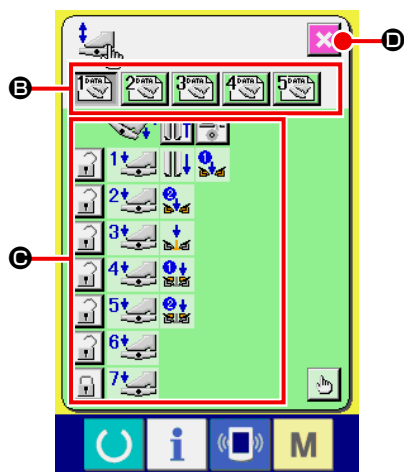



② Select from button **B** 5 kinds of pedal operation that are registered as customized. At this time, the contents of selected pedal operation data are displayed at **C**.

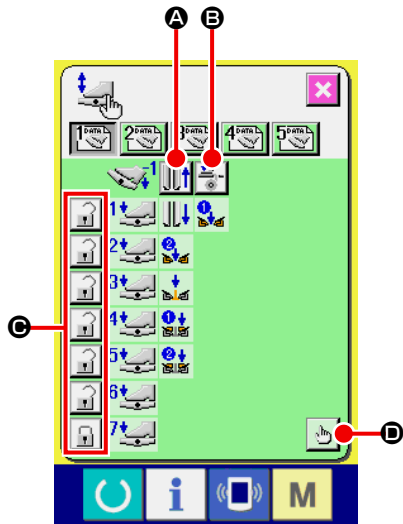

③ When SCREEN END button **D** is pressed, the selected pedal operation data is determined and the screen returns to the original screen.

Pedal customizing screen
(Screen A)



(2) Customizing the pedal operation data





- ① Press button  **A**, and set whether to make the clamp foot recede or not with the pedal depressed to the reverse step.

Display	Description
	To make clamp foot recede
	Not to make clamp foot recede

- ② Press button  **B**, and set whether or not the interlining presser actuate with the pedal depressed to the reverse step.

Display	Description
	To actuate
	Not to actuate

- ③ Press button  **C** and set whether or not to lock the respective pedal operations of first to seventh steps.
In case of “lock”, even when the pedal is released, the motion state by pedal operation is held unless the pedal is depressed to the reverse step or reset of pedal is performed.

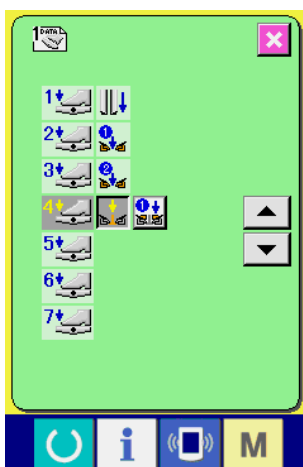

Display	Description
	To lock
	Not to lock



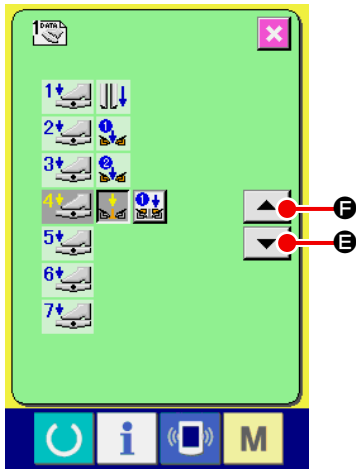

Pedal motion function setting screen
(Screen A)

- ④ Press button  **D**, and the pedal motion function setting screen (screen A) is displayed. Then the motion function to be registered to the number of the respective pedal steps can be set.



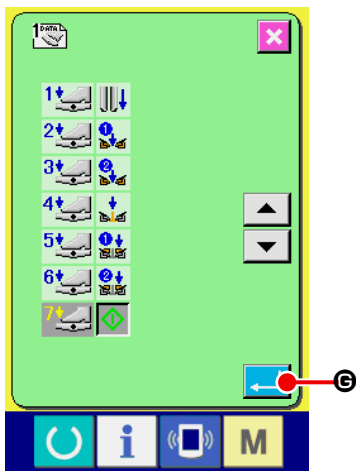







⑤ Functions below can be registered from first step in order. Functions that can be registered are in the state of button as  , and displayed in order. When the button is pressed, the color changes and the function is registered. The number of pedal steps is advanced with ▲ ▼ button  ⑤. When the number of pedal steps is returned with  ⑥, it becomes the state before one.



When functions are registered up to the last, ENTER button  ⑥ is displayed. Press it to determine the registered data.

- * It is possible to clear and register the number of pedal steps.
- * When the function is determined without registering MACHINE START  , knee switch start is applied.
- * Whether or not the clamp foot comes down from right or left is determined by **U019** clamp foot lowering order change-over. When right and left are set to the same time, even if the independent motion is set in this screen, the right and the left actuate at the same time.
- * Whether or not the flap presser comes down from right or left is determined by **U018** flap presser lowering order change-over.

When right and left are set to the same time, even if the independent motion is set in this screen, the right and the left actuate at the same time.

Display	Description	Display	Description
	Dart stretcher (optional)		Binder down
	Vacuum suction		Flap presser one side down
	Clamp foot one side down		Flap presser remaining side down
	Clamp foot remaining side down		Machine start

13. CUSTOMIZING THE DATA INPUT SCREEN

Buttons displayed in the data input screen can be customized in accordance with the customers' using conditions.

(1) Customizing procedure

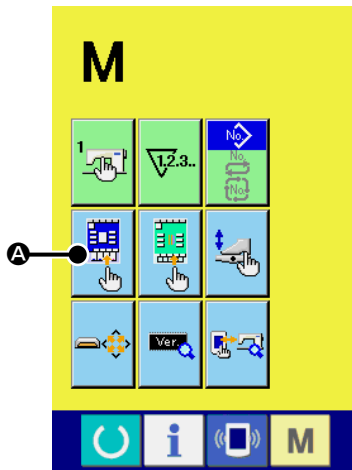

① Display the customizing screen of the input screen





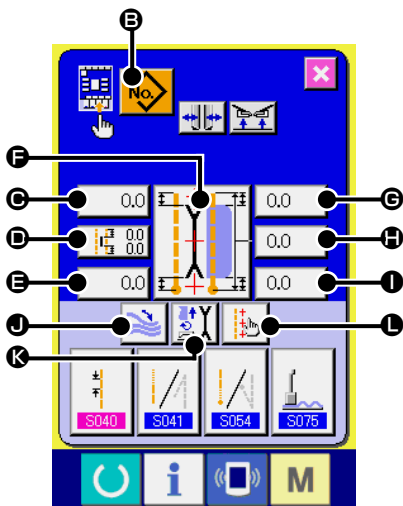

















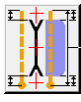
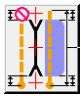
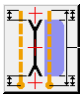







Keep pressing MODE CHANGEOVER key **M** for three seconds, and CUSTOMIZE button  **A** is displayed on the screen.

When this button is pressed, the customizing screen of the input screen is displayed.



② Select the conditions of buttons

Every time the buttons from **B** to **L** are pressed, display/non display of the buttons can be changed over. Customize and use the buttons in accordance with the customers' using conditions.

Symbol	Display	Non display	Description	Initial state
B			Pattern list button	
C			Flap concealed stitching data (Left sewing start)	
D			Center knife motion position setting	
E			Flap concealed stitching data (Left sewing end)	
F			Sewing mode change-over	
G			Corner knife motion position at sewing start	
H			L size setting	
I			Corner knife motion position at sewing end	
J			Stacker stop/motion change-over	
K			Motion mode change-over	
L			Marking light setting	

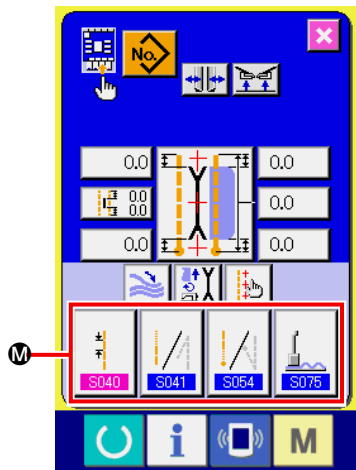

③ **Register the sewing data to SEWING DATA CUSTOMIZING button**

Up to 4 sewing data can be registered to SEWING DATA CUSTOMIZE buttons (M).

Register and use the sewing data that are frequently used.

When pressing CUSTOMIZING button (M) you desire to register, the sewing data list (screen A) is displayed.

④ **Select the sewing data to be registered**

Select the sewing data you desire to register with SEWING DATA button (N).

When the selected button is pressed twice, the selection is released.

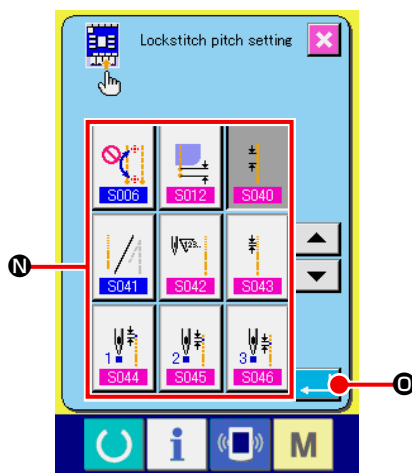





⑤ **Register the data to the customizing button**

When ENTER button (O) is pressed, register to the customizing button ends, and the screen returns to the customizing screen of the input screen. The registered sewing data is displayed on CUSTOMIZING button (M).

**Sewing data list screen
(Screen A)**

The data below have been registered in order from the left at the time of your purchase.

a.		Lockstitch pitchy
b.		Condensation/back tack at sewing start selection
c.		Condensation/back tack at sewing end selection
d.		Dart stretcher stop/motion change-over

14. PERFORMING THE CUSTOMIZING SETTING OF THE SEWING SCREEN

Buttons displayed in the data input screen can be customized in accordance with the customers' using conditions.

(1) Customizing procedure

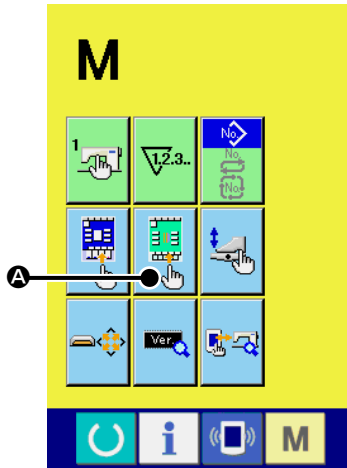

① Display the customizing screen of the sewing screen

Keep pressing MODE CHANGEOVER key **M** for three seconds and SEWING SCREEN CUSTOMIZING button **A** is



A is

displayed on the screen.

Press this button and the customizing screen of sewing screen is displayed.

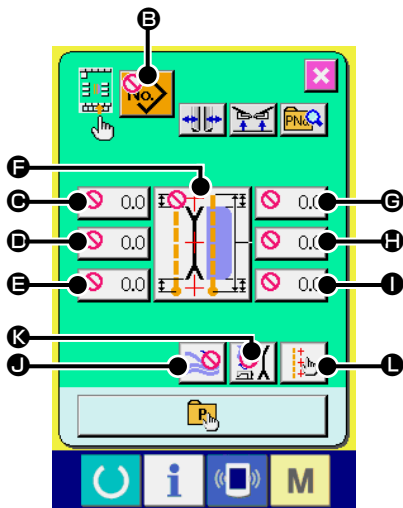

② Set the conditions of buttons

Every time the buttons from **B** to **L** are pressed, button display/non display can be changed over. Customize and use the buttons in accordance with the customers' using conditions.

Symbol	Display	Non display	Description	Initial state
B			Pattern list button	
C			Flap concealed stitching data (Left sewing start)	
D			Center knife motion position setting	
E			Flap concealed stitching data (Left sewing end)	
F			Sewing mode change-over	
G			Corner knife motion position at sewing start	
H			L size setting	
I			Corner knife motion position at sewing end	
J			Stacker stop/motion change-over	
K			Motion mode change-over	
L			Marking light setting	

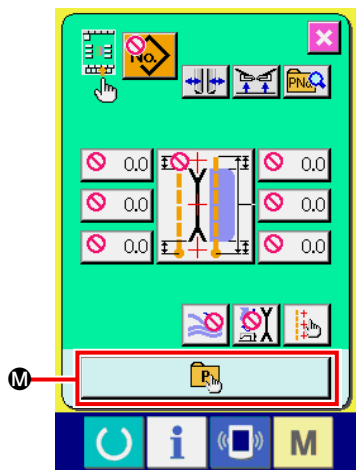

③ **Register the direct pattern.**

When DIRECT PATTERN REGISTER button **M** is pressed, the direct pattern register list screen (screen A) is displayed.

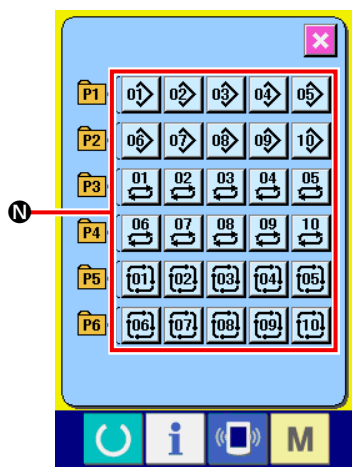

Direct pattern list screen
(Screen A)

In the direct pattern list screen, the pattern data of independent sewing/alternate sewing/cycle sewing can be freely registered up to 30.

Register and use the pattern data that are frequently used. Press PATTERN LIST button **N** and the direct pattern selection screen (screen B) is displayed.

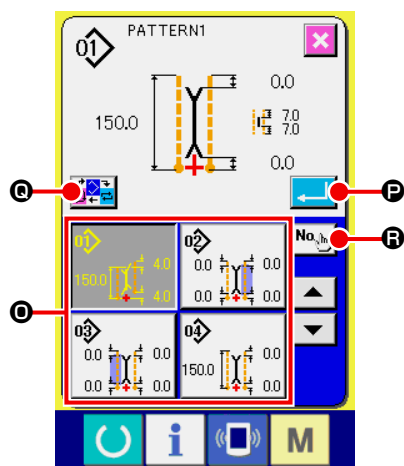

Direct pattern selection screen
(Screen B)

Select the pattern you desire to register with PATTERN SELECTION button **O**.

In addition, the ten keys are displayed by pressing NO. INPUT button **R** and the pattern you desire to register can be selected by inputting the ten keys.



When the selected button is pressed again, the selection is released.

When ENTER button **P** is pressed, register to the direct button is completed and the screen returns to the direct pattern list screen (screen A).

When MODE CHANGEOVER button **Q** is pressed, the sewing mode is changed over to independent sewing → alternate sewing → cycle sewing.



The direct buttons have not been registered at the time of your purchase.

15. USING THE INFORMATION

There are three functions below, in the information function.

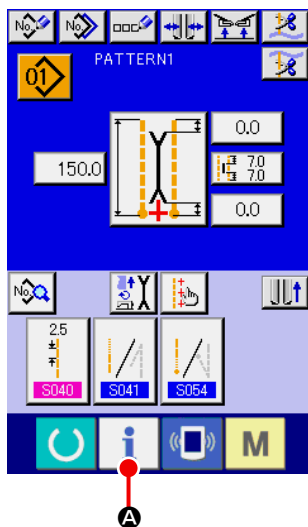

① Display the information screen

Press INFORMATION key  **A** of the switch seat section in the input screen and the information screen (screen A) is displayed.

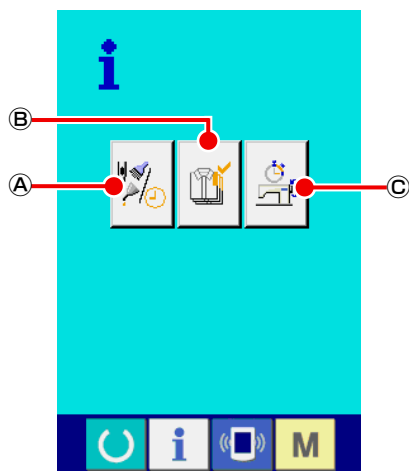

Information screen
(screen A)

Ⓐ Maintenance inspection information

Oil replacement (grease-up) time, needle replacement time, cleaning time, etc. are specified, and when the specified time has passed, the warning notice can be performed. See "[VI-15.\(1\) Observing the maintenance inspection information](#)" p. 80.

Ⓑ Production control information

By means of function to display target production and actual production, the target achieving consciousness of a line or a group is enhanced and also the progress can be confirmed in one glance.

See "[VI-15.\(3\) Observing the production control information](#)" p. 82 and "[VI-15.\(4\) Performing setting of the production control information](#)" p. 84.

Ⓒ Operation measurement information

Information on machine operating situation, machine operating rate, pitch time, machine time, and machine speed can be displayed.

See "[VI-15.\(5\) Observing the operation measurement information](#)" p. 86.

(1) Observing the maintenance inspection information

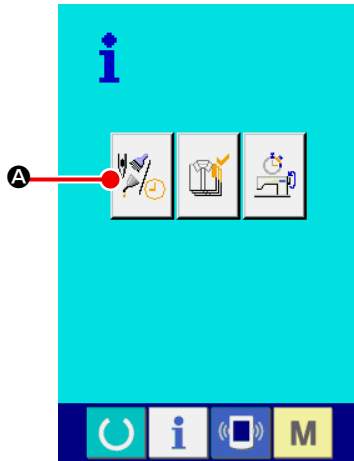

- ① **Display the maintenance information screen**
 Press MAINTENANCE INSPECTION INFORMATION SCREEN
 DISPLAY button  **A** of the information screen.

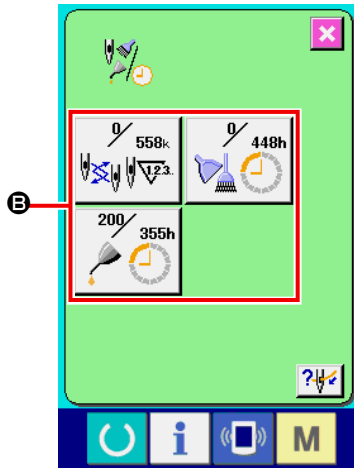

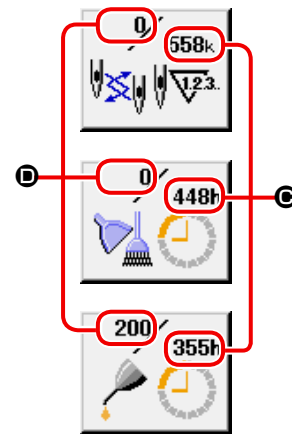

Three items of the information below are displayed in the maintenance inspection information screen.

- Needle replacement (1,000 stitches) :
- Cleaning time (hour) :
- Oil replacement time (hour) :

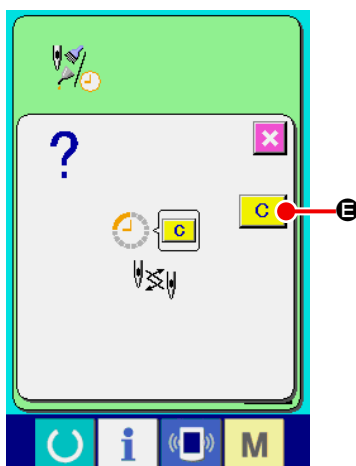

Interval **E** to inform the inspection and remaining time **D** up to replacement are displayed in the respective item buttons **B**.
 Also, the remaining time up to the replacement can be cleared.



- ② **Perform CLEAR of the remaining time up to the replacement**
 Press ITEM button **B** you desire to clear and the replacement time clear screen is displayed.
 Press CLEAR button  **E**, and the remaining time up to the replacement is cleared.

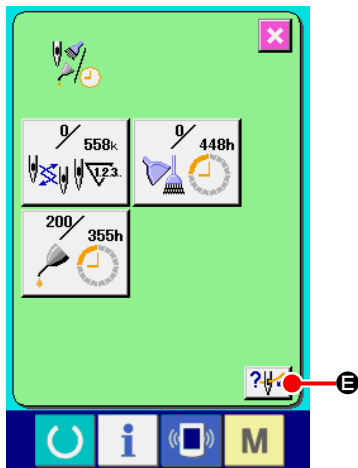

③ Display the threading diagram

Press THREADING button  **E** displayed in the maintenance inspection information screen and the needle thread threading screen is displayed.

See when performing threading.

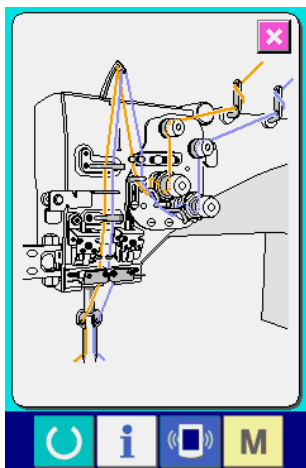

(2) Releasing procedure of the warning

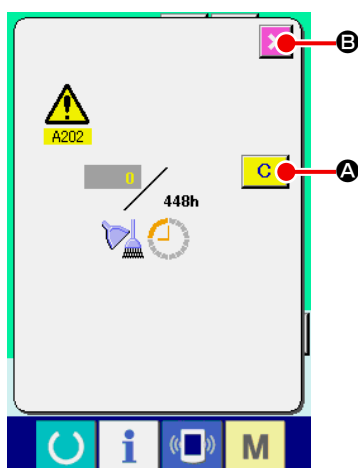

When the specified inspection time is reached, the warning screen is displayed. In case of clearing the inspection time, press CLEAR button

 **A**. The inspection time is cleared and the pop-up is closed. If

not, press CANCEL button  **B** and close the pop-up. Every time one sewing is completed, the warning screen is displayed until the inspection time is cleared.

Warning Nos. of the respective items are as follows.

- Needle replacement : A201
- Cleaning time : A202
- Oil replacement time : A203

(3) Observing the production control information

It is possible to designate the start, display the number of pieces of production from the start to the existing time, display the number of pieces of production target, etc. in the production control screen. There are two kinds of display ways for the production control screen.

[In case of displaying from the information screen]

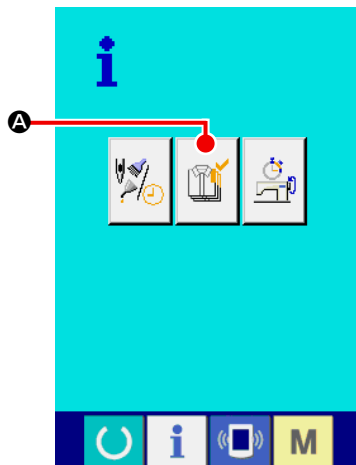

① Display the production control screen

Press PRODUCTION CONTROL SCREEN DISPLAY button



A in the information screen. The production control screen is displayed.

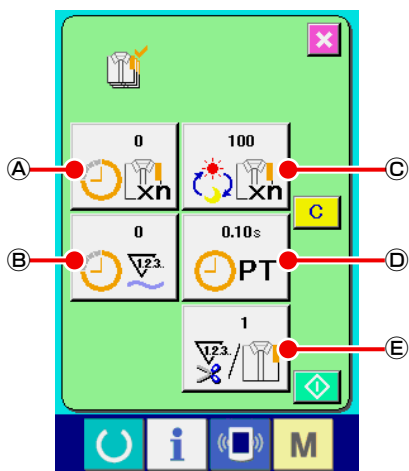

The production control screen is displayed.

- Ⓐ : Existing target value
Number of pieces of the target of sewn products at the present time is automatically displayed.
- Ⓑ : Actual results value
Number of pieces of the sewn products is automatically displayed.
- Ⓒ : Final target value
Number of pieces of the final target of sewn products is displayed.
- Ⓓ : Pitch time
Time (second) required for one process is displayed.
- Ⓔ : Number of times of thread trimming
Number of times of thread trimming per process is displayed.



Refer to "VI-15.(4) Performing setting of the production control information" p. 84, and input Ⓒ number of pieces, Ⓓ time (unit : second) and Ⓔ number of times.

[In case of displaying from the sewing screen]

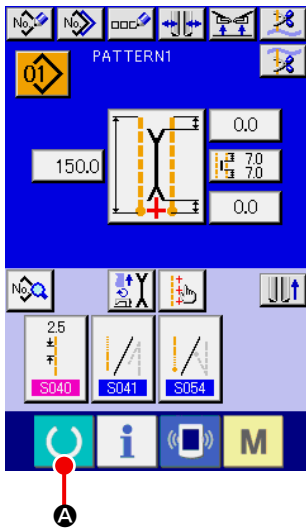

① Display the sewing screen

Press READY key  **A** in the input screen and the sewing screen is displayed.

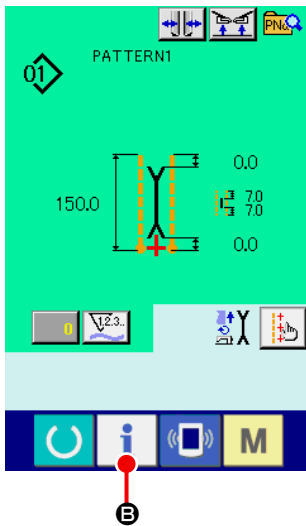

② Display the production control screen

Press INFORMATION key  **B** in the sewing screen and the production control screen is displayed.

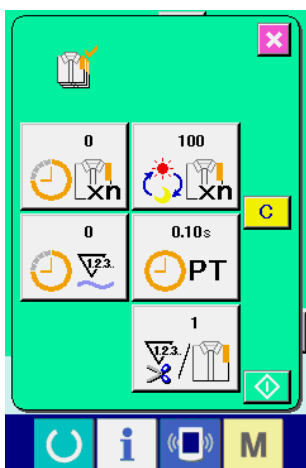

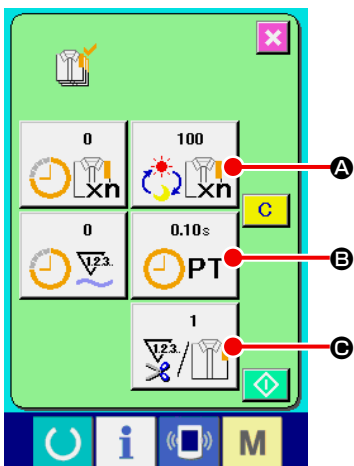

The contents of display and the functions are common to “In case of displaying from the information screen”.

(4) Performing setting of the production control information



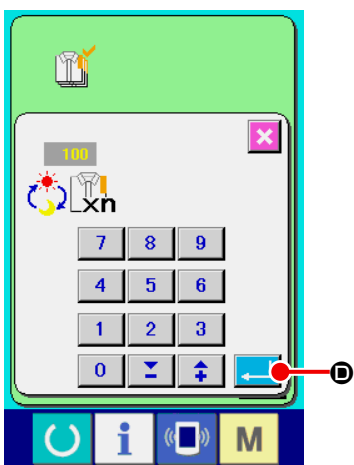

- ① **Display the production control screen**
Refer to "VI-15.(3) Observing the production control information" p. 82 and display the production control screen.



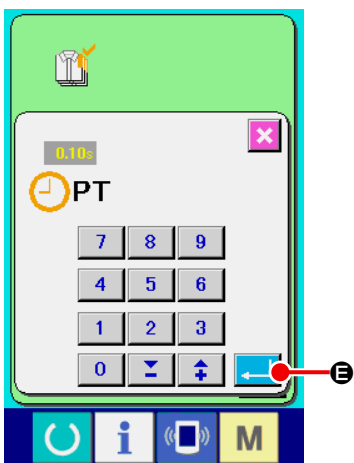

- ② **Input the final target value**
First, input the number of pieces of the target of production in the process to which sewing is performed from now on.
When FINAL TARGET VALUE button  A of item ① is pressed, the final target value input screen is displayed. Input the value you desire with ten keys or UP/DOWN buttons. After the input, press ENTER button  D.

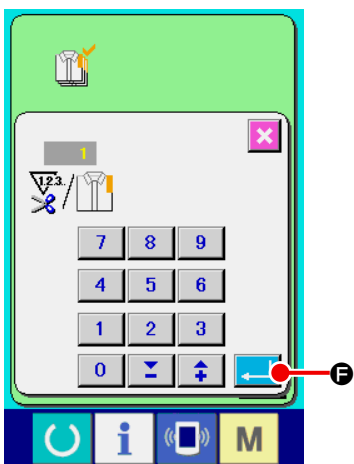

- ③ **Input the pitch time**
Next, input the pitch time required for one process.
When PITCH TIME button  B of item ① is pressed, the pitch time input screen is displayed. Input the value you desire with ten keys or UP/DOWN buttons. After the input, press ENTER button  E.



- ④ **Input the number of times of thread trimming**
Next, input the number of times of thread trimming per process. When NUMBER OF TIMES OF THREAD TRIMMING button  C of item ① is pressed, the number of times of thread trimming input screen is displayed. Input the value you desire with ten keys or UP/DOWN buttons. After the input, press ENTER button  F.
- * When the input value is "0", count of the number of times of thread trimming is not performed. Use this function by connecting the external switch.

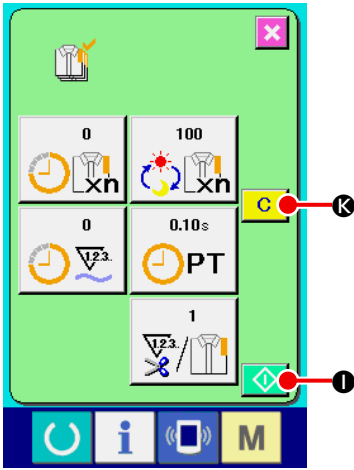



⑤ **Start the count of number of pieces of production**

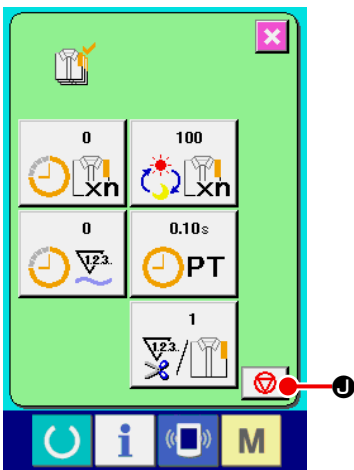

Press START button  ① and the count of number of pieces of production is started.



⑥ **Stop the count**

Display the production control screen referring to **"VI-15.(3) Observing the production control information"** p. 82.

When the count is being performed, STOP button  ① is displayed. When STOP button  ① is pressed, the count is stopped.

After the stop, START button  ① is displayed at the position of STOP button. When continuing the count, press START button  ① again. The counted value is not cleared until CLEAR button  ① is pressed.

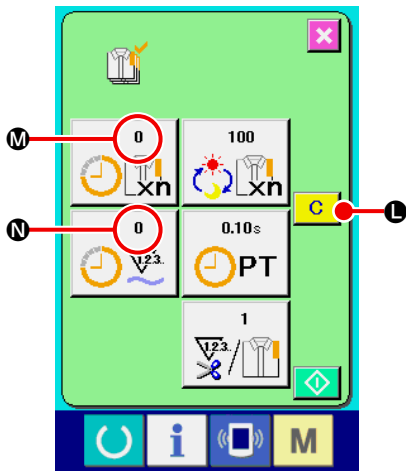



⑦ **Clear the counted value**

When clearing the counted value, set the count to the stop state and press CLEAR button  ①.

The value to be cleared is the present target value **M** and actual results value **N**.

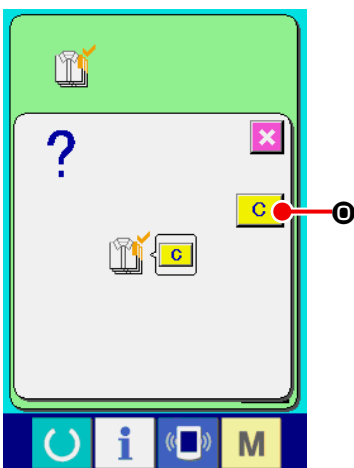
* CLEAR button is displayed only in case of stop state.



When CLEAR button  ① is pressed, the clear confirmation screen is displayed.

When CLEAR button  ① is pressed in the clear confirmation screen, the counted value is cleared.

(5) Observing the operation measurement information

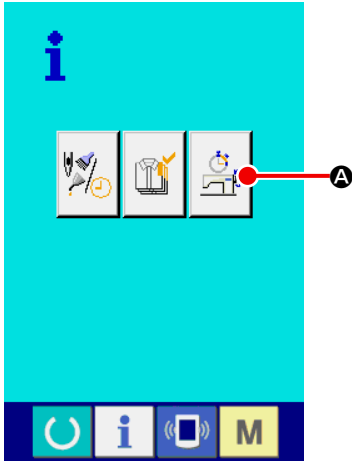

① Display the operation measurement screen

Press OPERATION MEASUREMENT SCREEN DISPLAY button



A in the information screen. The operation measurement screen (screen A) is displayed.

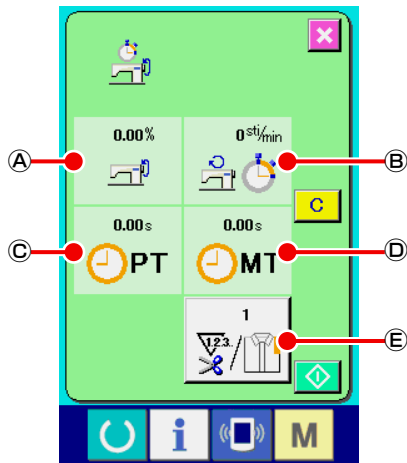

Operation measurement screen
(Screen A)

Information on the following 5 items is displayed in the operation measurement screen.

- Ⓐ : This item automatically displays the operation rate from the time of starting the measurement.
- Ⓑ : This item automatically displays the mean machine speed from the time of starting the measurement.
- Ⓒ : This item automatically displays the mean pitch time from the time of starting the measurement.
- Ⓓ : This item automatically displays the mean machine time from the time of starting the measurement.
- Ⓔ : This item displays the number of times of thread trimming per process.
Input the number of times referring to item ② below.

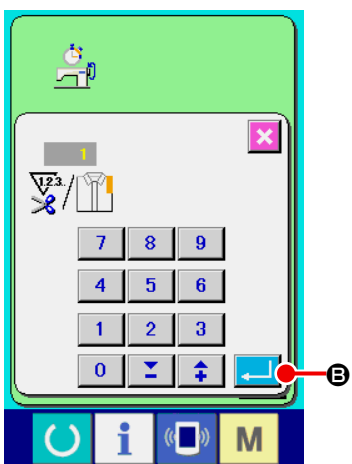

② Input the number of times of thread trimming

Next, input the number of times of thread trimming per process.

Press NUMBER OF TIMES OF THREAD TRIMMING button



E and the number of times of thread trimming input screen is displayed.

Input the value you desire with ten keys or UP/DOWN buttons.

After the input, press ENTER button  **B**.

- * When the input value is “0”, count of the number of times of thread trimming is not performed. Use this function by connecting the external switch.

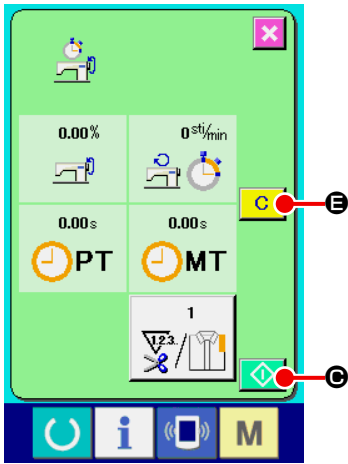



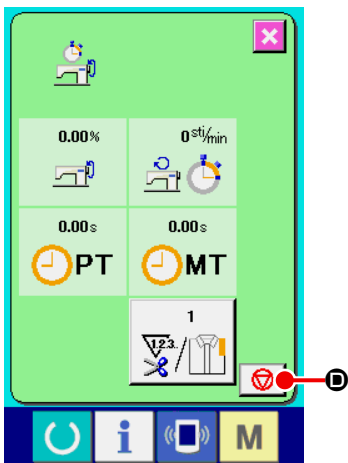

③ Start the measurement

Press START button  **Ⓒ**, and the measurement of each data is started.



④ Stop the count

Display the operation measurement screen referring to Items ① and ② of "["VI-15.\(5\) Observing the operation measurement information"](#) p. 86.

When the measurement is being performed, STOP button  **Ⓓ** is displayed. When STOP button  **Ⓓ** is pressed, the measurement is stopped.  **Ⓒ** is displayed at the position of STOP button. In case of continuing the measurement, press again START button  **Ⓒ**. The measured value is not cleared until CLEAR button  **Ⓔ** is pressed.

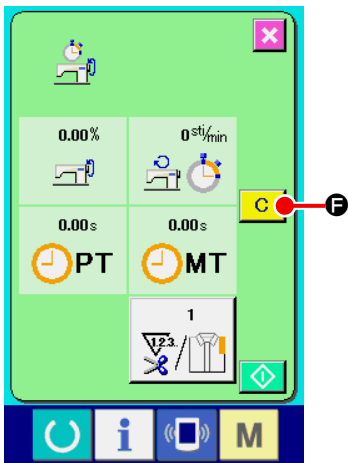



⑤ Clear the counted value

When clearing the counted value, set the count to the stop state and press CLEAR button  **Ⓕ**.

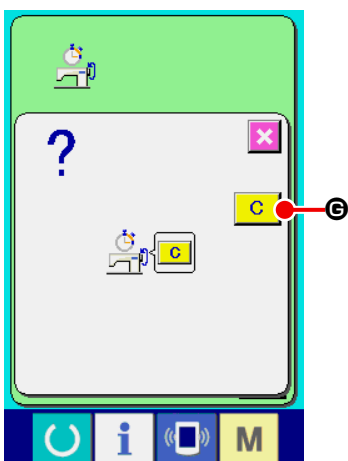
* CLEAR button is displayed only in case of stop state.



When CLEAR button  **Ⓕ** is pressed, the clear confirmation screen is displayed.

When CLEAR button  **Ⓖ** is pressed in the clear confirmation screen, the counted value is cleared.

16. USING THE COMMUNICATION FUNCTION

Communication function can download the sewing data created with other sewing machine . In addition, the function can upload the aforementioned data to the media or personal computer.

As the means of communication, a media slot and USB are prepared.

(1) Handling possible data

Data name		Extension	Description of data
Sewing data		APW xxx .EPD	Sewing data created by the sewing machine exclusive for APW

xxx : File No.

(2) Performing communication by using the media

For handling way of the media, read "[VI-1. PREFACE](#)" p. 21.

(3) Performing communication by using USB

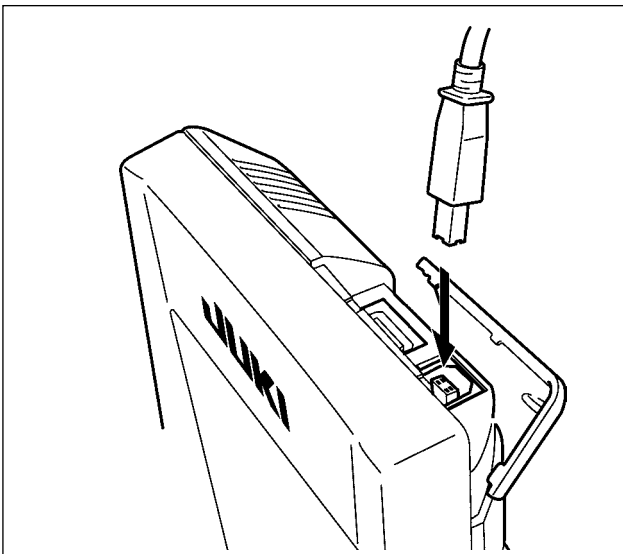

Data can be sent/received to/from a personal computer or the like, by means of a USB cable.



If the contact part becomes dirty, failure of contact will be caused. Do not touch by hand, and control so that dust, oil or other foreign material does not adhere to it. In addition, the inside element is damaged by static electricity or the like. So, be very careful when handling.

(4) Take-in of the data

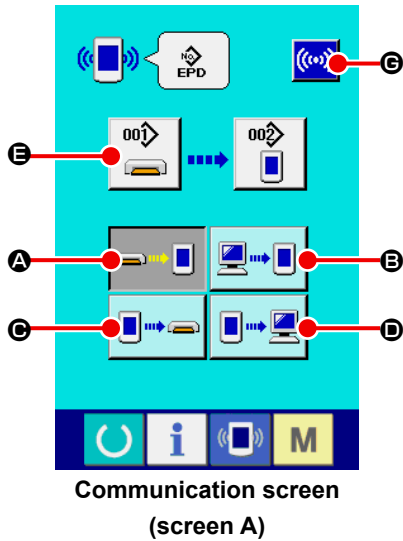

① Display the communication screen

When COMMUNICATION key  of switch seat section is pressed in the input screen, the communication screen (screen A) is displayed.

② Select the communication procedure

There are four communication procedures as described below.

- Ⓐ Writing data from media to panel
- Ⓑ Writing data from personal computer (server) to panel
- Ⓒ Writing data from panel to media
- Ⓓ Writing data from panel to personal computer (server)

Select the button of communication procedure you desire.

③ Select the data No.

When  Ⓔ is pressed, the writing file selection screen is displayed.

Input the file No. of the data you desire to write. For the file No., input APW***. of the file name and the numerals of the part *** of EPD. Designation of the pattern No. of writing destination can be performed in the same way. When the writing destination is the panel, pattern Nos. which have not been registered are displayed.

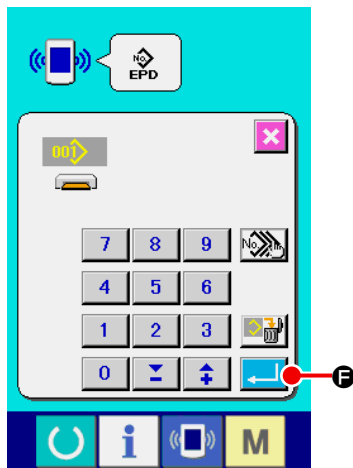

④ Determine the data No.

When ENTER button  Ⓕ is pressed, the data No. selection screen is closed and the screen returns to the communication screen (screen A).

⑤ Start communication

When COMMUNICATION START button  Ⓖ is pressed, the data communication starts.

The during communication is displayed during communication and the screen returns to the communication screen after the end of communication.



Do not open the cover during reading the data. Data may not be read in.

(5) Take-in of plural data together

It is possible for the sewing data to select plural data to be written and write all together. Pattern No. of writing destination is the same No. of the selected data No.



No.99 and after of the media cannot perform the plural selection.



① Display the writing file selection screen

Press PLURAL SELECTION button **A** and the data No. plural selection screen is displayed.

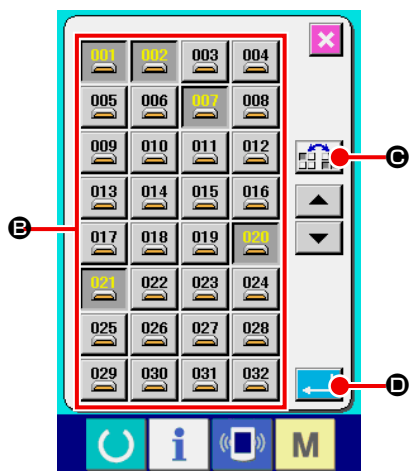

② Perform the selection of data No.

List of the file No. of the existing data is displayed. Press FILE No. buttons **B** you desire to write. It is possible to reverse the selection state of the button with REVERSE button **C**.

③ Determine the data No.

When ENTER button **D** is pressed, the data No. plural selection screen is closed and the selection of data ends.

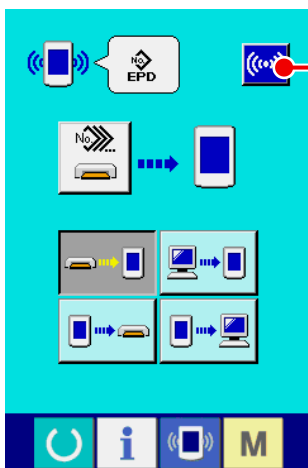

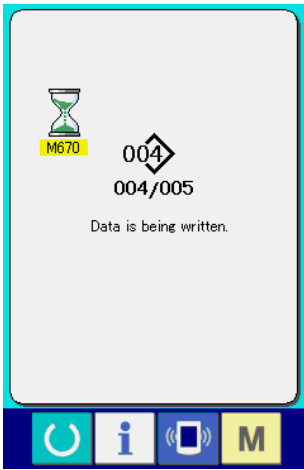

④ Start the communication

Press COMMUNICATION START button **E** and the data communication starts.

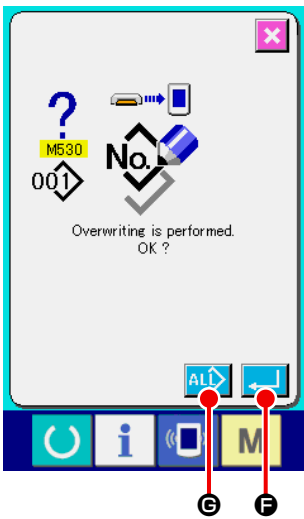

Data No. during communication, total number of writing data and number of data that have finished the data communication are displayed in the during communication screen.



* When performing writing to the pattern No. that already exists, the overwriting confirmation screen is displayed before writing. When performing overwriting, press ENTER button  **F**. When performing overwriting to all without displaying the overwriting confirmation screen, press OVERWRITING button  **G** in all cases.

17. PERFORMING FORMATTING OF THE MEDIA

When re-formatting the media, be sure to perform it with IP-420. The media that have been formatted with the personal computer cannot be read with IP-420.

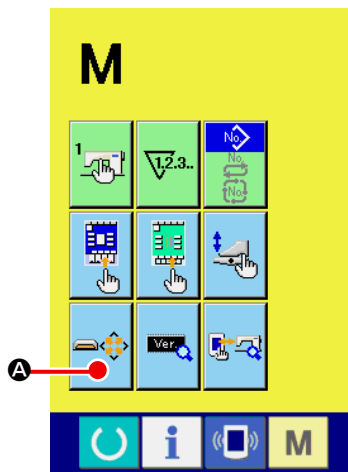

① Display the media format screen

Keep pressing MODE CHANGEOVER key **M** for three sec-

onds and MEDIA FORMAT button  **A** is displayed on the screen. When this button is pressed, the media format screen is displayed.

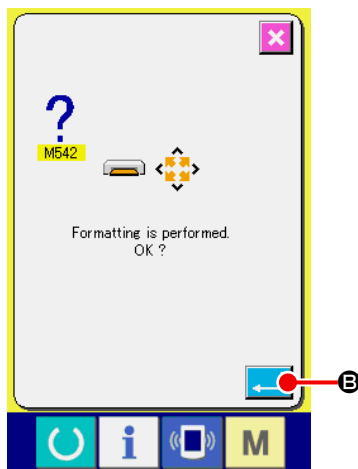

② Start formatting of the media

Set the media you desire to format to the media slot, press ENTER button  **B** after closing the cover and formatting starts.

Store the necessary data in the media to other media before formatting. When formatting is performed, the inside data are erased.

VII. MAINTENANCE

1. INSPECTION

Be sure to periodically execute the maintenance and inspection to keep the performance of this machine.
Be sure to periodically execute the work since machine trouble may be caused unless the maintenance and inspection are performed.

(1) Maintenance and inspection of the pneumatic device



CAUTION :

To prevent accidents caused by abrupt start of the sewing machine, do not place hand(s), foot, face or tools on the machine moving part.

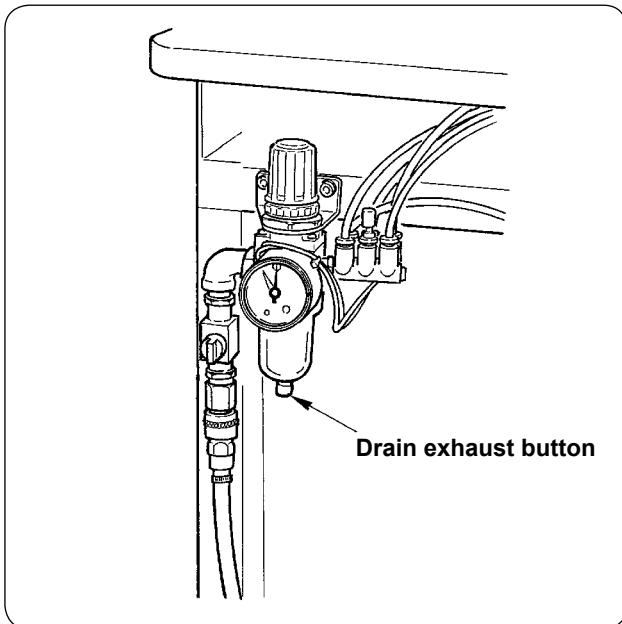

- Discharge the drain of filter every day.
Press the drain exhaust button located at the bottom of filter to exhaust the drain.

(2) Maintenance and inspection related to the sewing machine



CAUTION :

To prevent accidents caused by abrupt start of the sewing machine, start the work after turning OFF the power.

- When dust adheres to the small places of the machine such as clamp foot or the like, normal operation is disturbed. Be sure to perform cleaning before the work. In addition, be sure to clean the thread waste in the hook cover once a week.
- Check the sharpness of center knife and corner knife before the work, and try to replace it in good time.
- For the lubrication of the sewing machine, be sure to use the designated oil JUKI MACHINE OIL No. 1 (MDFRX1600C0).
- Periodically replace the thread guide felt. (Refer to "[V-1.\(3\) How to pass the needle thread](#)" p. 14).

(3) With regard to the waste oil of the hook oil



CAUTION :

To prevent accidents caused by abrupt start of the sewing machine, start the work after turning OFF the power.

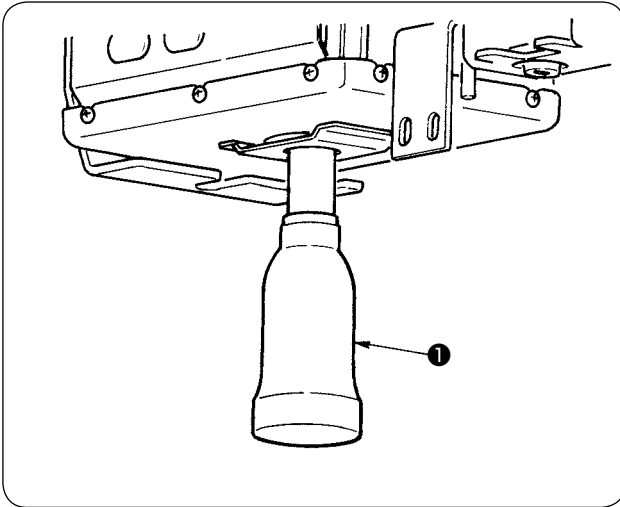

Turn and remove the oil can, and drain the waste oil when the waste oil gathered in approximately half of oil can ❶ located on the machine bed cover.

(4) With regard to the cleaning of the hook shaft base



CAUTION :

To prevent accidents caused by abrupt start of the sewing machine, start the work after turning OFF the power.

Periodically clean the waste cloth or the like gathered in the hook oil cover.

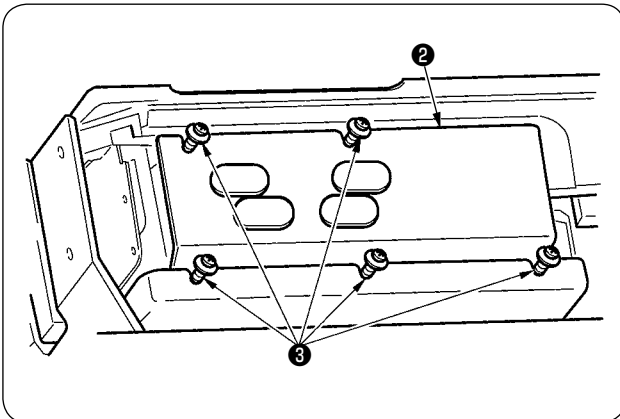

- Raise the machine head and remove oil cover ❷ after loosening setscrews ❸ (5 places).

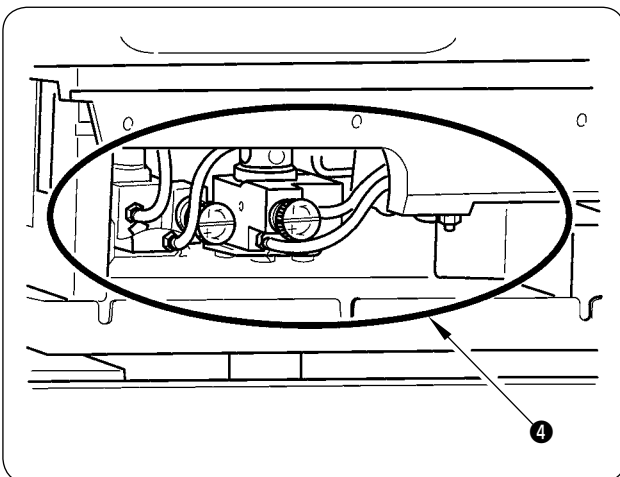

- Clean the inside of hook oil cover ❹ .

2. MARKING LIGHT



WARNING :

1. If the laser light directly enters the eye, eyesight trouble may be caused.
Do not look into the laser inlet/outlet.
2. Never perform installing/removing of the marking lamp with the power turning ON.
In addition, do not use the light other than marking.

(1) Marking light for sewing reference setting

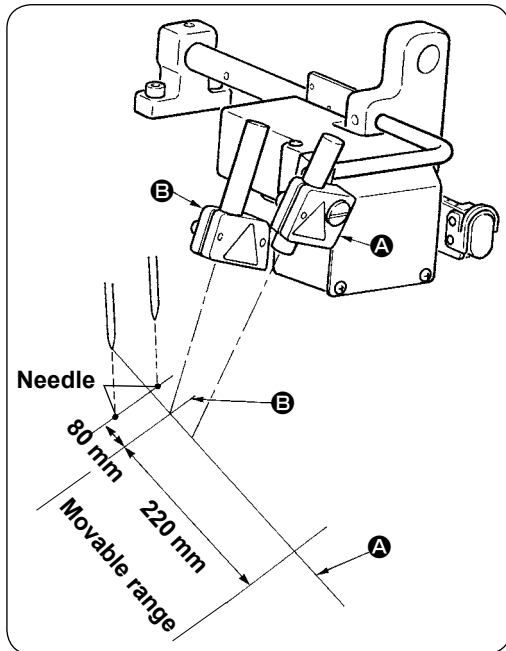

The light of marking light on the front side observed from the operator side is used for longitudinal line reference setting (fixed) **A** and that in the rear side is used for lateral line reference setting (moving according to the sewing type) **B**.

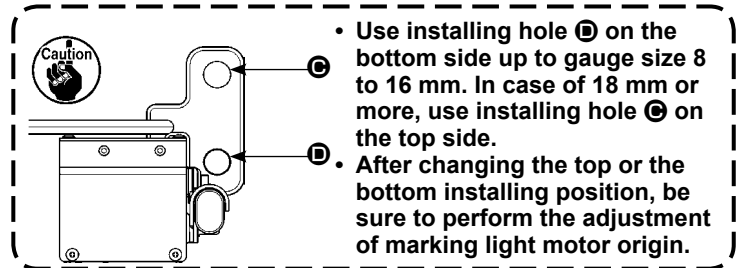

Laser specifications	
Lateral line reference laser	Longitudinal line reference laser
Class 2 laser product	Class 2M laser product
Maximum output: 1.0mW	Maximum output: 3.5mW
Wave length: 650nm	Wave length: 650nm
Safety standard	
JIS C 6802:2011	
IEC60825-1+A2:2007	

(2) Adjusting the marking light irradiation position

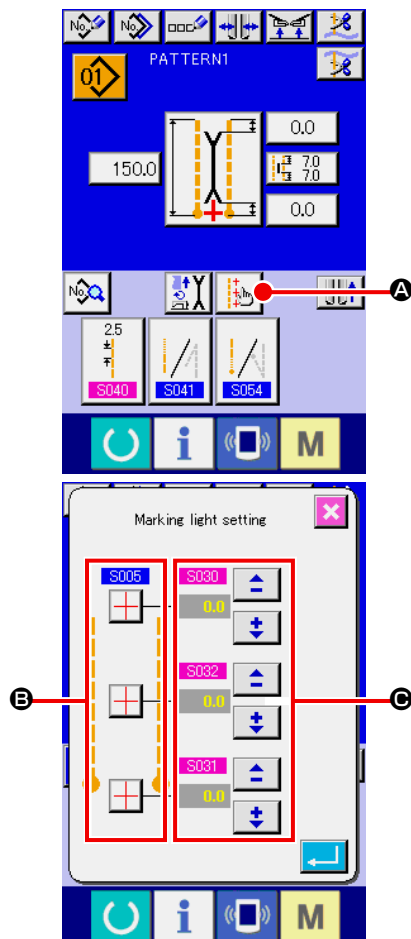

Press button **A** in the input screen and the marking light setting screen is displayed. Then the irradiation position of marking light can be adjusted.

Lateral line irradiation position of marking light is determined by the sewing type, and the irradiation position is automatically moved by **B** "S005 change-over of sewing start irradiation/sewing end irradiation/center irradiation" and "S004 L size setting".



When the compensation value of **C** is 0.0 mm, the marking light irradiates the sewing position.



When you desire to move the marking light irradiation position in terms of the sewing position, set each compensation value of **C** for use.

- S030** : Sewing start irradiation position compensation
- S031** : Sewing end irradiation position compensation
- S032** : Center irradiation position compensation

3. REPLENISHING GREASE TO THE DESIGNATED PLACE

* When “Grease-up warning E220” or “Grease-up error E221” is displayed, or when the machine has been used for one year, be sure to perform replenishing of grease.

When turning ON the power after the sewing machine has operated up to 40 million stitches, “grease-up warning E220” informing of the time of grease replenishment is displayed on the panel. When pressing RESET button  to leave the error screen, the machine can continue operating. However, the error has not been released and the error is displayed every time the power is turned ON. After performing replenishment of grease which is explained later, call “Memory switch  ” and set the number of stitches of operation to “0” with CLEAR button .

When the machine has been continuously used up to 48 million stitches, “grease-up error E221” is displayed on the panel. In this case, even when RESET button  is pressed and the error screen is released, the sewing after that cannot be performed. Be sure to call “Memory switch  ” and set the number of stitches of to “0” with CLEAR button  after performing replenishment of grease which is explained later.



1. “Grease-up warning E220” and “Grease-up error E221” are displayed again unless memory switch  is cleared to “0” after replenishing grease.
2. Be sure to use the grease tube (Part No. : 40006323) supplied with the machine as accessories for replenishing grease to the designated place which is explained later. If any grease other than the designated one is replenished, Component breakage will be caused.
3. Keep the used grease tube in a safe place.



CAUTION :

To prevent accidents caused by abrupt start of the sewing machine, start the work after turning OFF the power.

(1) Grease-up procedure

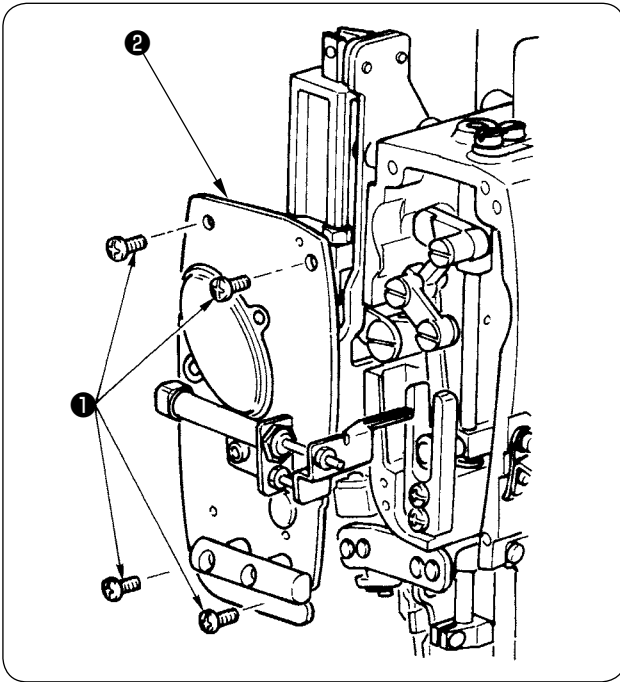

- ① Remove four setscrews ① and take out face plate ② .

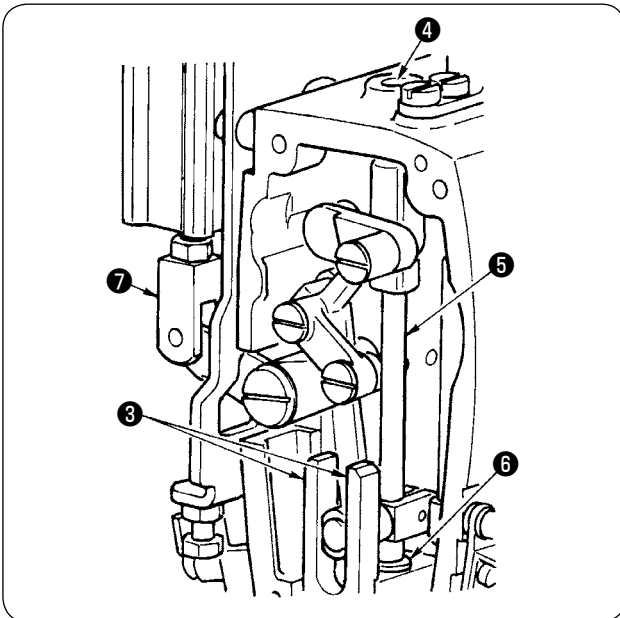

- ② Replenishment of grease to the center knife section
- Apply grease to both planes of guides ③ , knife bar metal, upper ④ , and knife bar metal, lower ⑥ .
 - Knife bar ⑤ moves up and down by moving cylinder joint ⑦ up and down in the state that air is not supplied. Apply grease to the metal so as to infiltrate the inside.

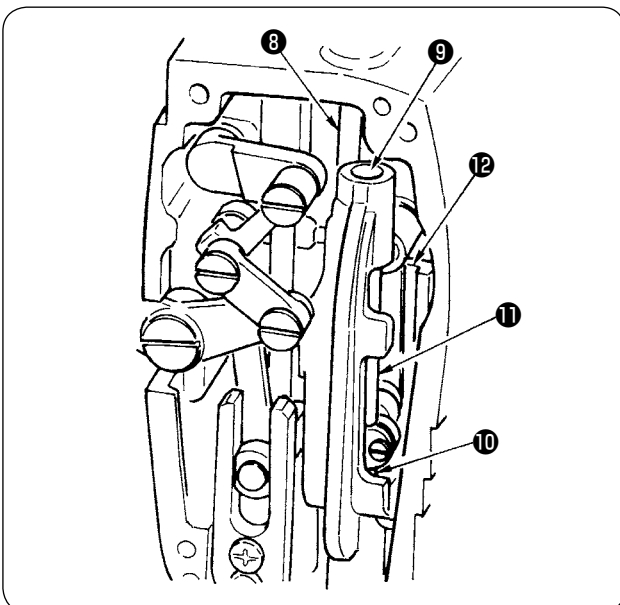

- ③ Replenishment of grease to the needle bar section
- Apply grease to thread take-up lever ⑧ , needle bar upper section ⑨ , needle bar lower section ⑩ , needle bar ⑪ and needle bar ⑫ .

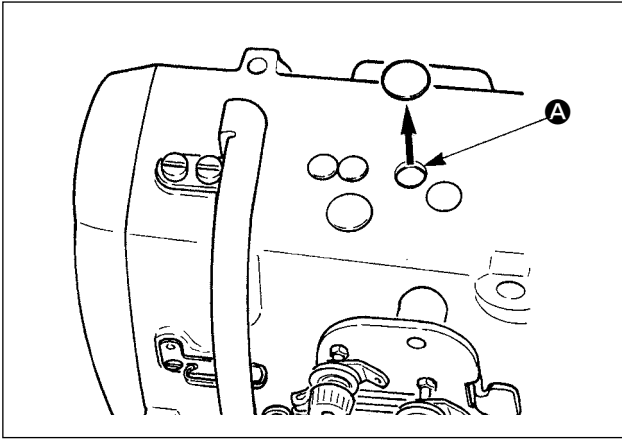

- ④ Remove the rubber cap and apply new grease to the inside of the hole after removing old grease adhered to the inside of hole **A**. Then cover the hole with the rubber cap.

4. CONSUMABLE REPLACEMENT COMPONENTS

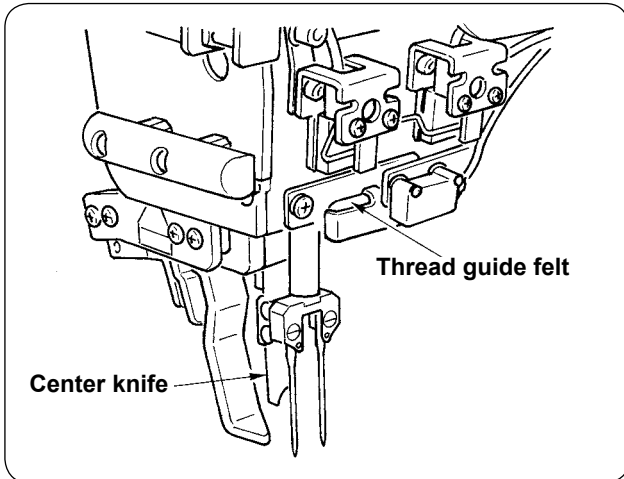

The components below are the consumable ones. Periodically replace them.

- **Thread guide felt (Part No. : 40034444)**

The part where thread passes is worn out and rough motion of thread is apt to occur unless it is periodically replaced.

- **Center knife (Part No. : 40026155)**

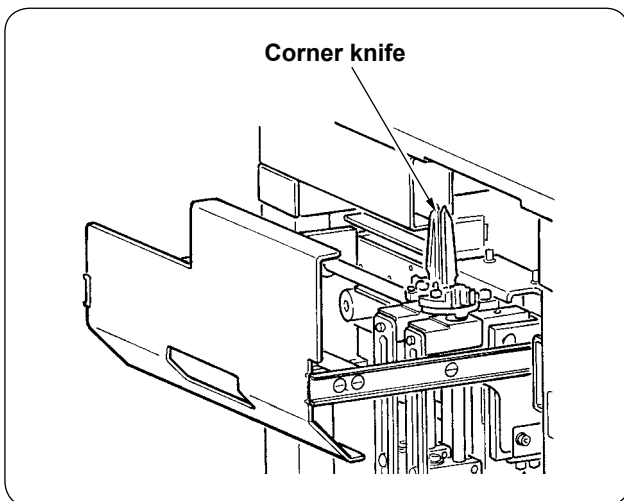

- **Corner knife**

Gauge size	Part No.
8 to 14mm	16607301, 16607400
16 to 20mm	16607509, 16607608
22 to 26mm	16607707, 16607806
28 to 32mm	16607905, 16608002

Sharpness is deteriorated and sewing quality is influenced unless it is periodically replaced.

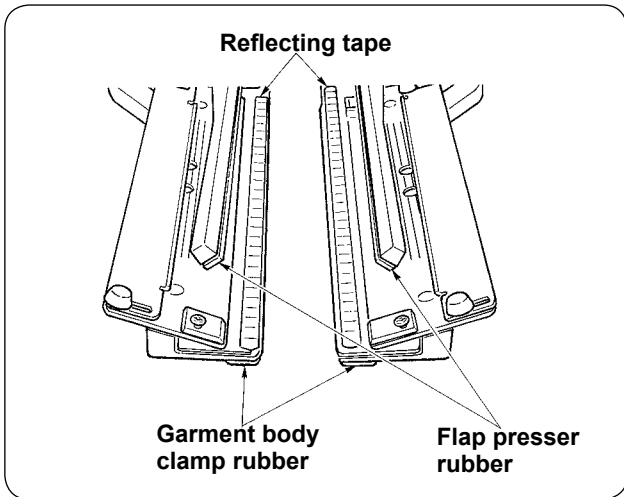

• **Reflecting tape**

	Part No.
Standard	40039942
Long and wide type	40056942

Accuracy of detection of flap is deteriorated and sewing quality is influenced unless it is periodically replaced.

• **Garment body clamp rubber**

	Part No.
Standard	40034825
Long and wide type	40040827

• **Flap presser rubber**

	Part No.
Standard	40034826
Long and wide type	40040829

Pressing of material is deteriorated and sewing quality is influenced unless it is periodically replaced.

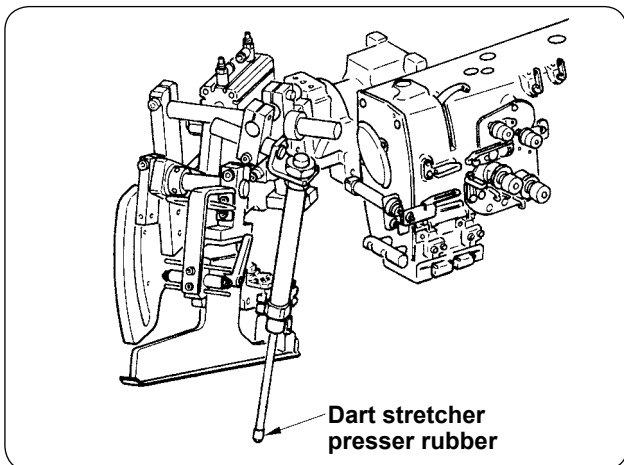

• **Dart stretcher presser rubber**
(Part No. : 40034733)

Pressing of material is deteriorated and sewing quality is influenced unless it is periodically replaced.

5. TILTING THE MACHINE

CAUTION :



- Turn OFF the power before starting the work so as to prevent accidents caused by abrupt start of the sewing machine.
- When tilting/raising the machine, be careful not to allow your hands, fingers or any other part of your body to be caught in the related parts.

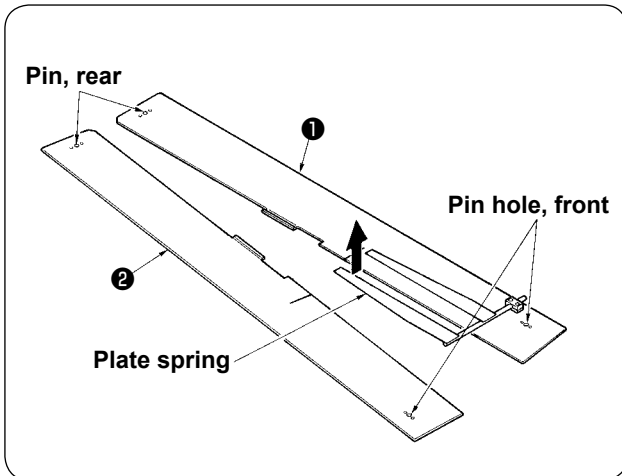

- ① Remove sewing tables ① and ② .

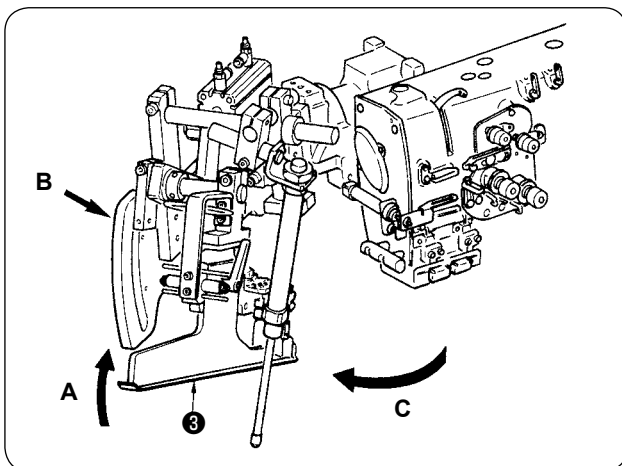

- ② Turn the binder unit.
Lift binder ③ in the direction **A**, support section **B** by hand and turn the whole binder in the direction **C**.



Binder is locked with ball plunger. Turn it rather strongly in the direction of **C** to release the lock.

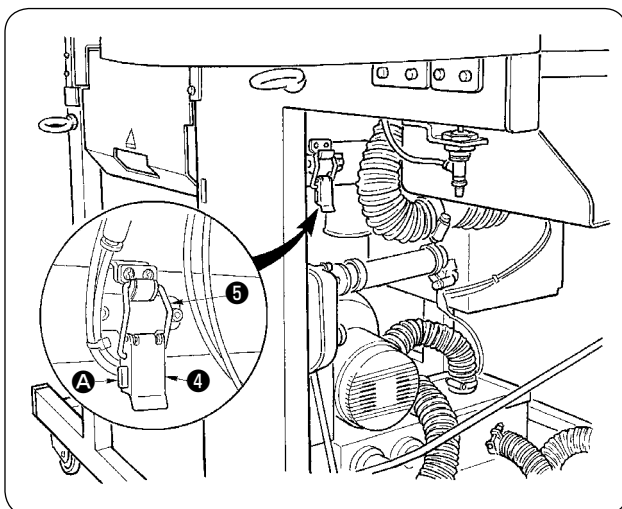

- ③ Release machine fixing hinge.
Pressing section **A**, release machine fixing hinge ④ , and remove hinge hook ⑤ .

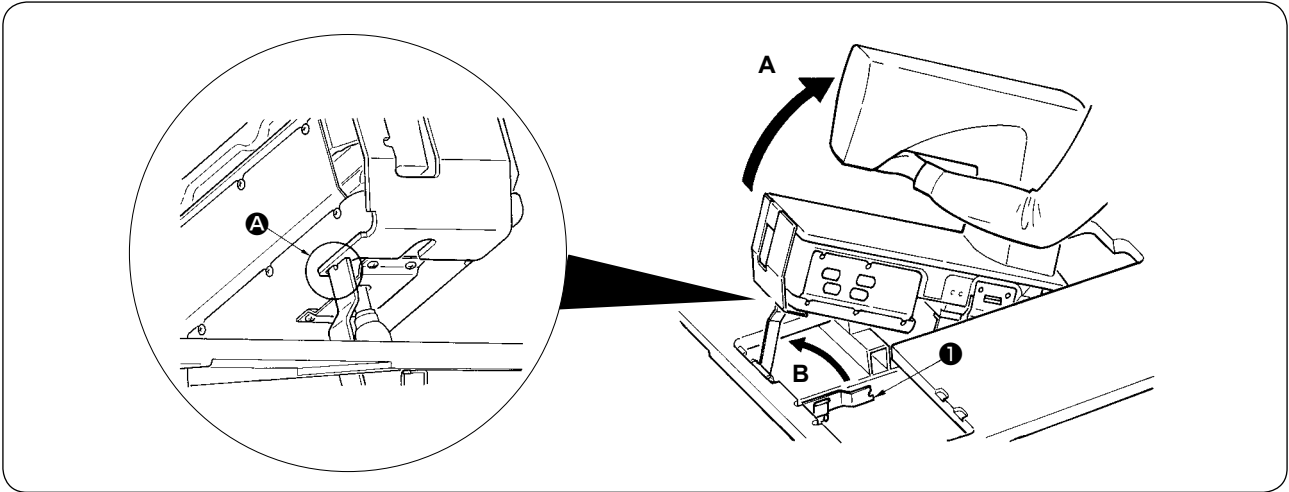

CAUTION :



1. For turning the sewing machine head, be sure to perform with two persons or more.
2. To avoid personal injuries, when returning the machine head from the raised state to the home position, return it to the home position after confirming that there is no tool or component under the gas spring.
3. To avoid personal injuries and damage of sewing machine, do not damage with tools or parts the rod section of the gas spring located under the machine head.
4. To avoid personal injuries, immediately replace the gas spring with a new one when the rod section of gas spring does not function properly with a flaw or the like, or it is judged as a defective one. [Do not use anything other than JUKI genuine gas spring (Part No. : 40023177).]
5. To avoid personal injuries, do not use with the gas spring removed.

④ Turn the sewing machine.

- Hold the bottom side of the machine arm and lift the whole sewing machine in the direction **A**.
- Lift the sewing machine fixing plate **1** in the direction **B**, put the point of the sewing machine fixing plate **1** to the hole of the machine bed, and fix the sewing machine. (Refer to **A**.)

⑤ When returning the sewing machine, set the sewing machine by reversing the procedure.

6. STANDARD OF REPLACING TIME OF THE GAS SPRING

CAUTION :



- Turn OFF the power before starting the work so as to prevent accidents caused by abrupt start of the sewing machine.
- When tilting/raising the machine, be careful not to allow your hands, fingers or any other part of your body to be caught in the related parts.

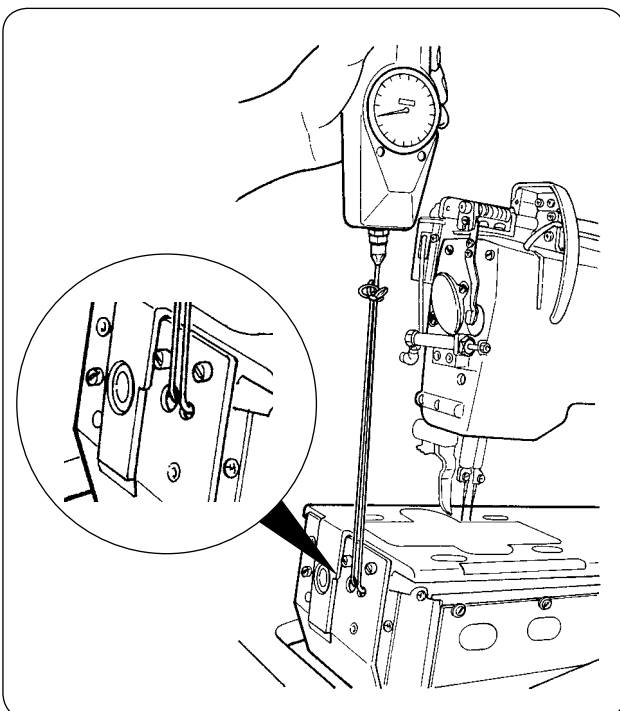

- 1) Gas spring is one of the consumables. Gas inside the gas spring will be gone naturally even when the frequency of use is low and the spring cannot display the thrust to secure the safety. In case a force of 130N or more is necessary when passing strings through the front end of machine bed and lifting the sewing machine as shown in the left-hand figure, quickly replace the spring with JUKI genuine gas spring (Part No. : 40023177).



Gas spring is a component that can be used with ease. However, there is a flaw on the rod section or a section that is weak in the side load when the gas spring is fully stretched. Be very careful when performing maintenance or cleaning of the sewing machine.

7. REPLACING PROCEDURE BETWEEN DOUBLE-WELT AND SINGLE-WELT



CAUTION :

To prevent accidents caused by abrupt start of the sewing machine, start the work after turning OFF the power.

(1) Replacing procedure between double-welt and single-welt

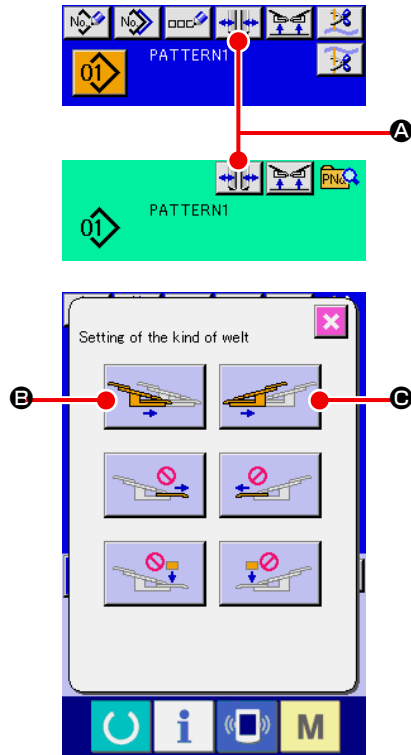

① Turn ON the power and advance the clamp foot.



In case of M004 the long and wide type, changeover of double-welt and single-welt cannot be performed with the clamp foot advanced.

② Press button  **A** to display the type of welt setting screen.

③ When button **B** is pressed, the left garment body clamp operates between inside and outside alternately. When button **C** is pressed, the right garment body clamp operates between inside and outside alternately.

Select the position of left and right garment body clamps In accordance with the sewing type.

In addition, press buttons **B** and **C** to operate the garment body clamp between inside and outside at the time of fine adjustment of the position of garment body clamps which is explained later.

(2) Fine adjustment of the position of garment body clamp

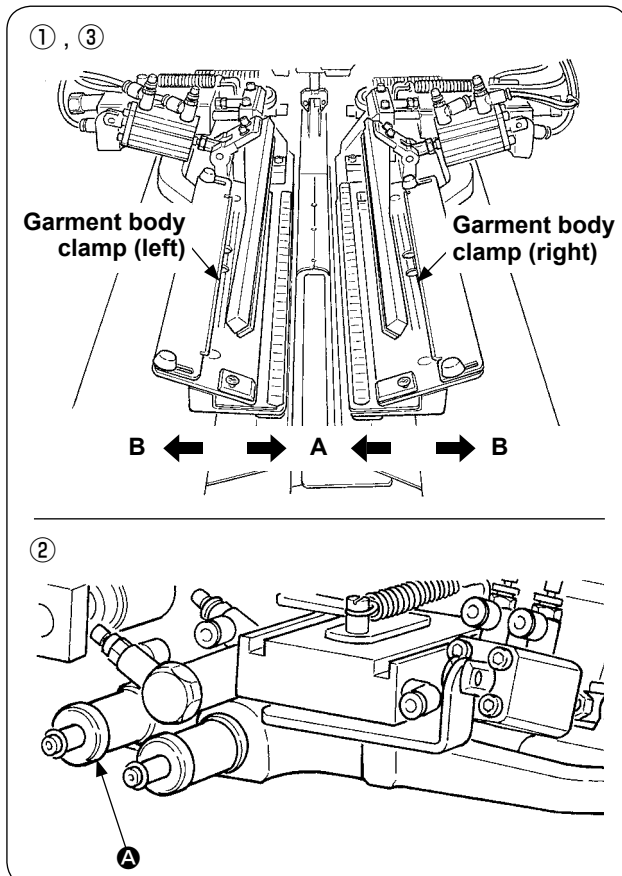

• Fine adjustment of double-welt type

① Move the position of garment body clamp to outside (direction **B**) on the panel.

② It is possible to perform the fine adjustment of the position of garment body with adjustment knob for double-welt **A**.

Move it clockwise to outside (direction **B**) and counterclockwise to inside (direction **A**).

③ Move the position of garment body clamp to inside (direction **A**) on the panel and confirm the position.

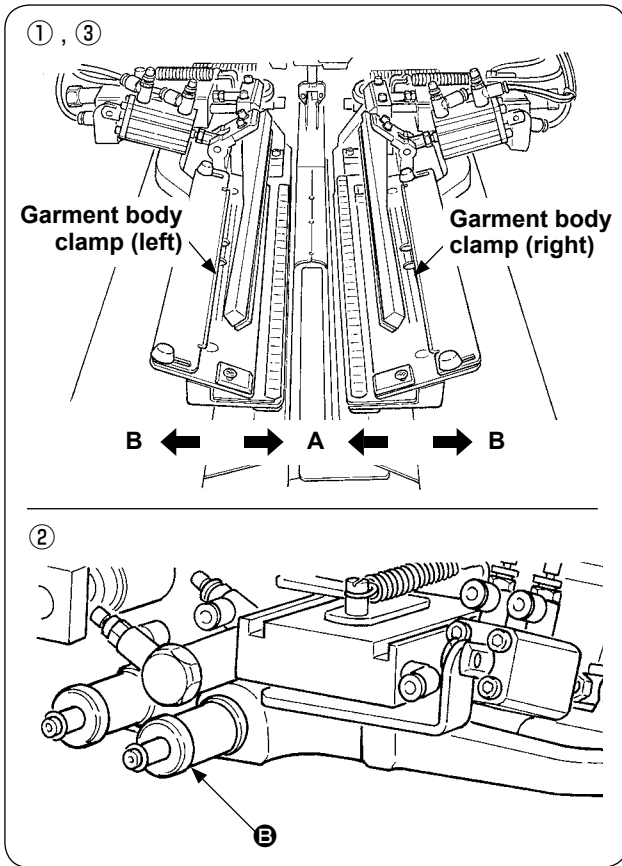

- Fine adjustment of single-welt type
- ① Move the position of garment body clamp to inside (direction **A**) on the panel.
- ② It is possible to perform the fine adjustment of the position with adjustment knob for single-welt **B**.
Move it clockwise to inside (direction **A**) and counterclockwise to outside.
- ③ Move the position of garment body clamp to outside (direction **B**) on the panel and confirm the position.

(3) Replacing the binder

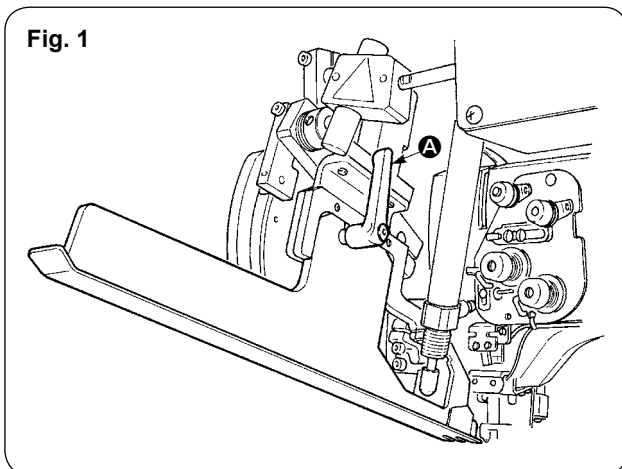

- ① Turn lever **A** counterclockwise with the binder lifted as shown in Fig. 1, and remove welting patch scale for double-welt (single-welt) (asm.).

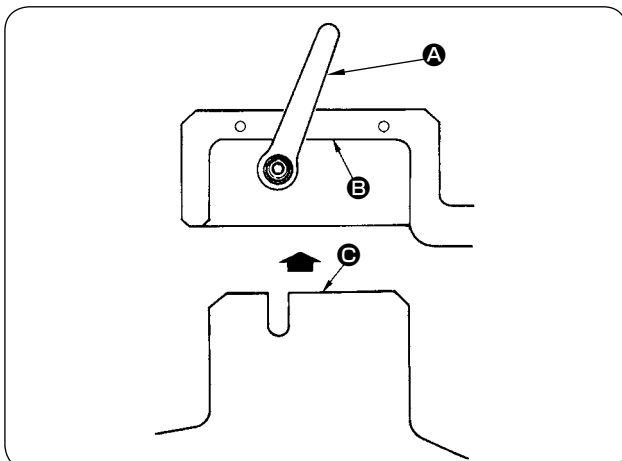

- ② Set welting patch scale for double-welt (single-welt) (asm.) and fix it with lever **A**.



When fixing the welting patch scale for double-welt (single-welt) (asm.), perform fixing in the state that plane **B comes in contact with plane **C**.**

8. ADJUSTING THE CORNER KNIFE

CAUTION :

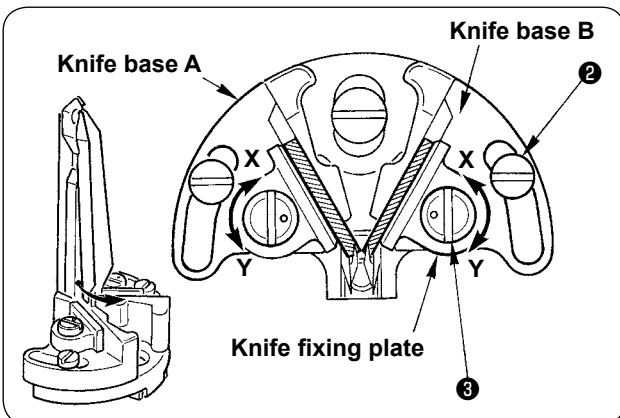
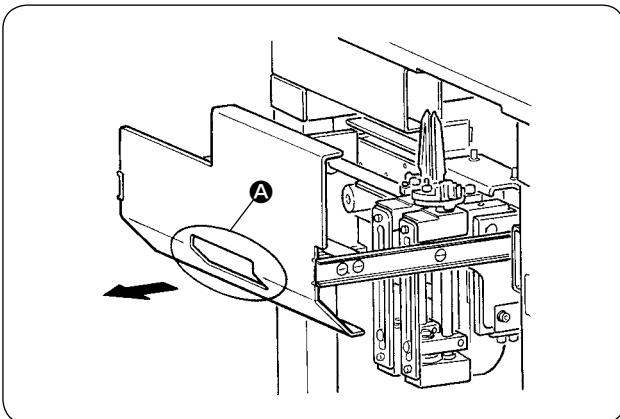
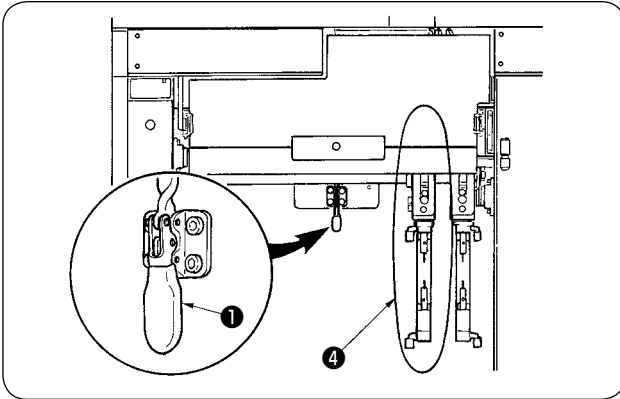

1. Turn OFF the power before starting the work so as to prevent accidents caused by abrupt start of the sewing machine.
2. Do not touch your fingers or hands to the blade section of knife. so as to prevent fatal accidents.
3. Perform the adjustment work by the maintenance engineers who are familiar with the sewing machine and trained for the safety so as to prevent accidents caused by unfamiliarity or wrong adjustment.
4. Be careful not to slip your hand since the adjustment work is performed with a screwdriver.



The angle of inclination of the corner knife of this model of machine has been factory-adjusted to approximately 60° at the time of delivery so that the blade tip of the knife does not easily come in contact with the rising part of the welting patch.

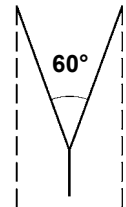

- ① Release toggle clamp ① .
- ② Hold section A and draw out the drawer in the direction of the arrow.



Draw it out. until it goes no further.

- ③ Adjustment procedure
[Adjusting the open angle of knife]

- 1) Loosen angle adjustment screws ② , adjust knife bases A and B, and fix the screws.

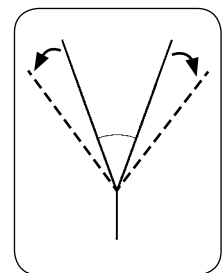

Direction of rotation to loosen left/right knives is different from each other.

[Adjusting the cutting length of knife]

- 1) Turn eccentric pin ③ in the direction of the arrow mark Y with a flat-blade screwdriver or the like and loosen the knife.
- 2) Tilt the knife and adjust the cutting length.
- 3) Turn eccentric pin ③ in the direction of the arrow mark X with a flat-blade screwdriver or the like and fix the knife.

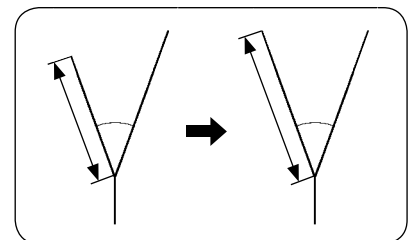

- ④ After the adjustment, return the drawer to its home position and fix it with toggle clamp ① .



When returning the drawer, return corner knife on the moving side ④ to the initial position.

9. ADJUSTING THE POSITION OF THE SENSOR FOR DETECTING FLAPS

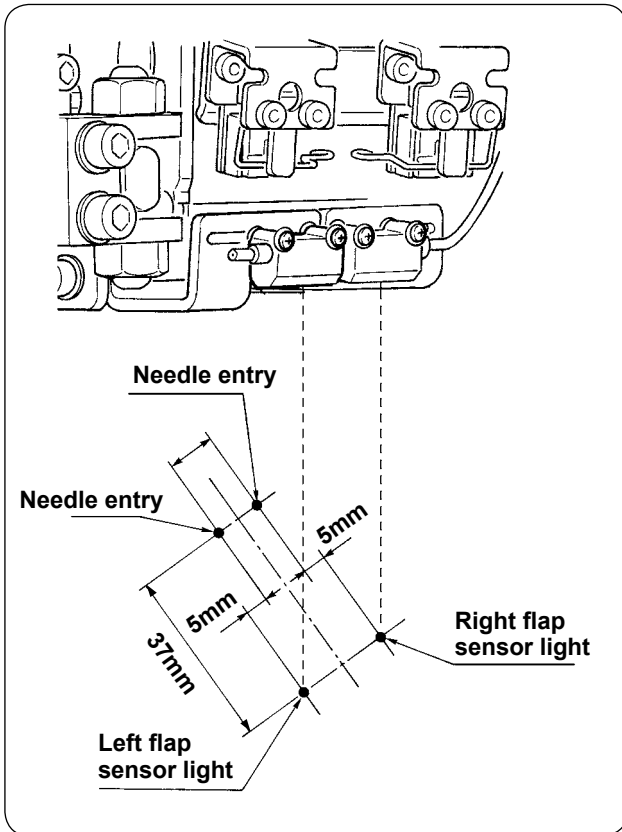

- Adjust the positions of both right and left sensors for detecting flaps to outside of 5 mm from the needle entry, and the sewing direction (longitudinal direction) of both right and left sensors to the position of 37 mm from the needle entry to the operator side.

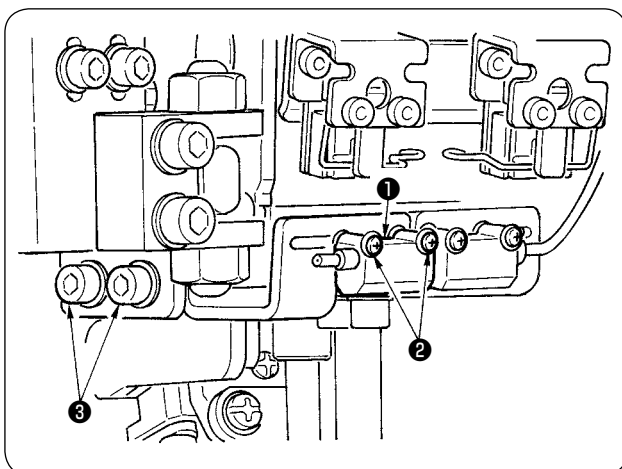

- Adjust the lateral direction of sensor for detecting left flap ① by loosening screws ② and moving the sensor in the lateral direction.
- Adjust the sewing direction of sensor for detecting left flap ① by loosening screws ③ and moving the sensor in the longitudinal direction.

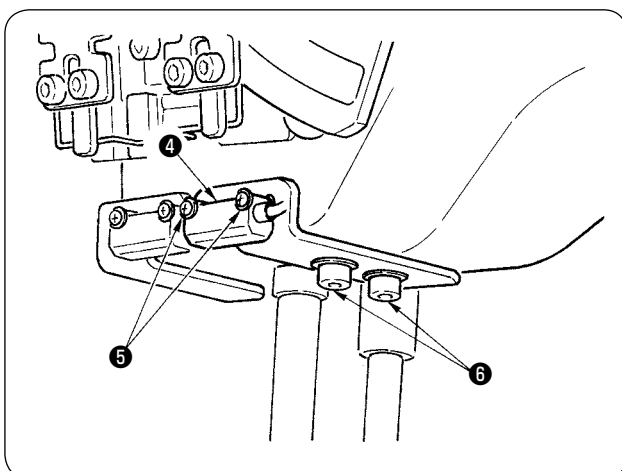

- Adjust the lateral direction of sensor for detecting right flap ④ by loosening setscrews ⑤ and moving the sensor in the lateral direction.
- Adjust the sewing direction of sensor for detecting right flap ④ by loosening screws ⑥ and moving the sensor in the longitudinal direction.



After the adjustment, be sure to perform trial sewing and adjust the flap sewing position with the panel.

10. CAUSES AND CORRECTIVE MEASURES AGAINST TROUBLES WITH THE BOBBIN THREAD REMAINING AMOUNT DETECTING DEVICE

Phenomenon	Cause	Corrective measure
<p>1) The bobbin thread remaining amount detecting function fails to work even when the bobbin thread has run out.</p>	<p>① The bobbin thread remaining amount adjusting counter has been improperly set.</p> <p>② The start position of bobbin wining is defective.</p> <p>③ The sensor amplifier fails to turn ON/OFF because of the stained lens.</p> <p>④ Sensor unit installing position.</p> <p>⑤ The bobbin used is not the exclusive one for the bobbin thread remaining amount detecting device.</p> <p>⑥ The bobbin case used is not the exclusive one for the bobbin thread remaining amount detecting device.</p> <p>⑦ The bobbin winder fails to wind the bobbin uniformly.</p> <p>⑧ The sensor cable connection failure.</p>	<p>○ Check the specified data on the bobbin thread remaining adjusting counter “ B008 ”. If the value of “ B008 ” is excessive, bobbin thread will run out before bobbin thread remaining amount detection count-up occurs. Refer to "VI-5. USING THE BOBBIN THREAD AMOUNT ADJUSTMENT COUNTER" p. 38.</p> <p>○ Start winding a bobbin from the recess designated.</p> <p>○ Check whether the solenoid valve for the bobbin thread remaining amount detecting device operates normally.</p> <p>○ Wipe clean the lens surface of the optical fiber unit.</p> <p>○ Check that the spot of sensor light irradiates the position of reflecting tape of bobbin.</p> <p>○ Use the exclusive bobbin for the bobbin thread remaining amount detecting device.</p> <p>○ Use the exclusive bobbin case for the bobbin thread remaining amount detecting device.</p> <p>○ Properly adjust the bobbin winder.</p> <p>○ Check how the sensor scale and MAIN circuit board are connected.</p>

11. HOW TO ADJUST THE FOOT PEDAL

The foot pedal of this device is so designed that an analog type pedal sensor detects the depressing depth of the foot pedal and the detected voltage value is taken as the operation step of the pedal.

However, the voltage value of the pedal sensor changes with a lapse of time. As a result, the depressing depth of the foot pedal can fail to match the operation step of the pedal. In this case, adjust the foot pedal as described below.

In addition, the adjustment value of the pedal is stored in memory of EEP-ROM of MAIN circuit board. If the circuit board is replaced, adjust the foot pedal taking the same procedure.

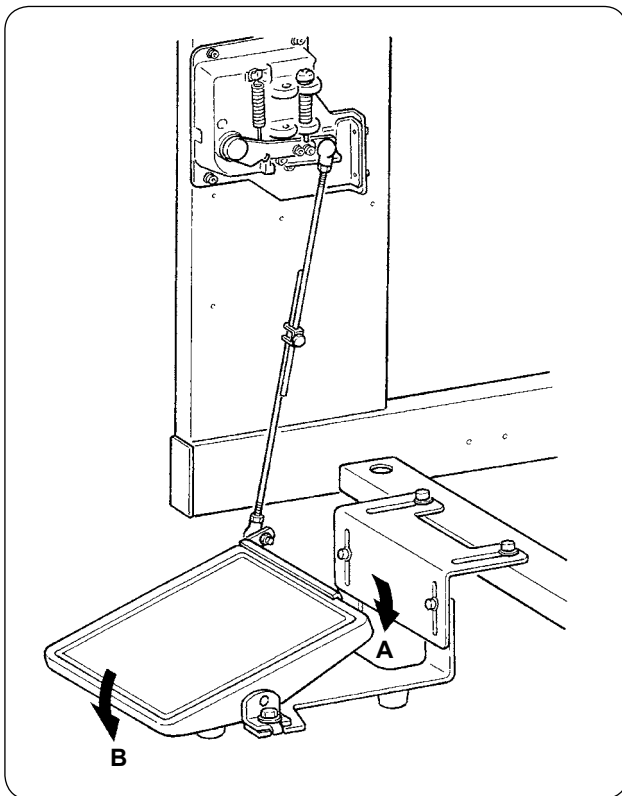

The pedal has 7 steps in the direction **A** and one step in the direction **B**.

Perform the panel setting in the respective steps.

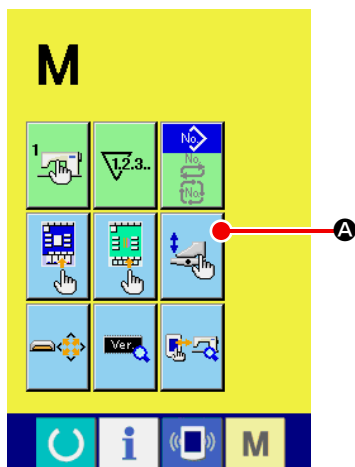

① Display the pedal customizing screen

Keep pressing MODE CHANGE-OVER key **M** for three sec-

onds and PEDAL CUSTOMIZING button  **A** displayed on

the screen changes the color from green to light blue.

Press this button and the pedal customizing screen of maintenance personnel level is displayed.

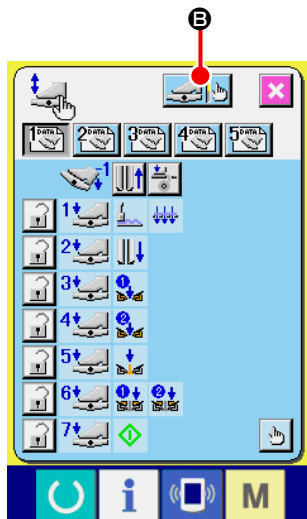

- ② When FOOT PEDAL ADJUSTMENT button  **E** is pressed, the foot pedal adjustment screen is displayed and the number of steps in terms of the depressing depth of the foot pedal is set.

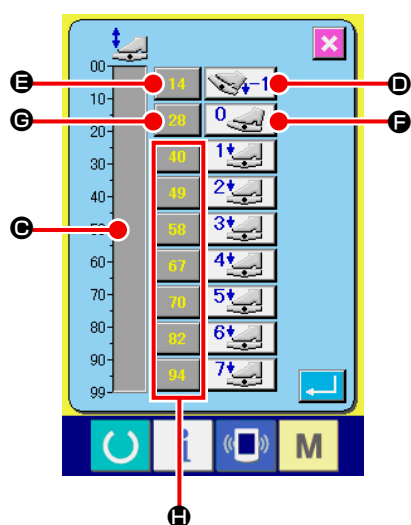









- ③ Pedal sensor voltage value in the present pedal depressing state is displayed in the range of 0 to 99 in the volume bar indication **C**. First, press PEDAL DEPRESSED TO REVERSE STEP INPUT button **D** with the foot pedal depressed to the reverse step. Voltage value of this time is inputted to **E**. Next, press FREE INPUT button **F** with the foot pedal free. Voltage value of this time is inputted to **G**. Using the same procedure, perform setting of first to seventh steps of the foot pedal, and input the voltage value of the respective pedal positions to buttons **E**, **G** and **H**.

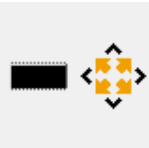

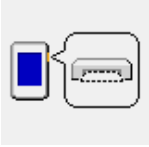



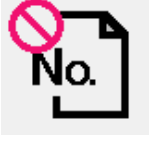





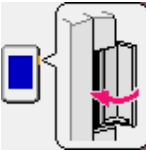





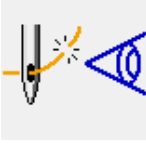

Set the voltage value so as to increase as the number of steps of the foot pedal increases.



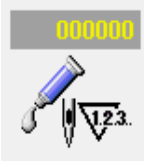

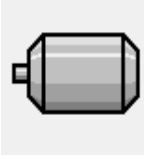
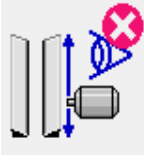

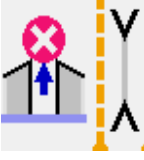

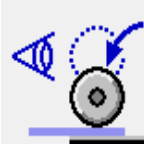
In addition, when directly pressing button **E**, **G** or **H**, the ten key input screen is displayed, and it is possible to directly input numerals.

12. ERROR CODE LIST



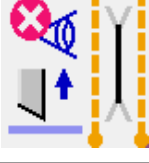

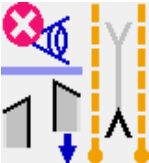

Error code		Description of error	How to recover
E001		Initialization of EEPROM of MAIN CPU	Turn OFF the power.
E007		Machine-lock Main shaft of the sewing machine does not rotate due to some trouble.	Turn OFF the power.
E010		Pattern No. error Pattern No. designated with ten-key is not registered when pattern No. is selected.	Possible to re-start after reset.
E011		External media not inserted Media is not inserted.	Possible to re-start after reset.
E012		Read error Data read from media cannot be performed.	Possible to re-start after reset.
E013		Write error Data write from media cannot be performed.	Possible to re-start after reset.
E015		Format error Formatting of media cannot be performed.	Possible to re-start after reset.
E016		External media capacity over Capacity of media is short.	Possible to re-start after reset.
E022		File No. error Designated file is not in server or media.	Possible to re-start after reset.
E024		Pattern data size over Memory size is over.	Possible to re-start after reset.

Error code		Description of error	How to recover
E027		Read error Data read from server cannot be performed.	Possible to re-start after reset.
E028		Write error Data write from server cannot be performed.	Possible to re-start after reset.
E029		Lid of media slot is open.	Possible to re-start after reset.
E030		Needle bar upper position failure Needle bar is out of needle UP position.	Possible to re-start after reset.
E031		Air pressure drop Air pressure is low.	Possible to re-start after reset.
E032		File interchanging error File cannot be read.	Possible to re-start after reset.
E045		Pattern data error Pattern data is corrupted.	Possible to re-start after reset.
E050		Stop switch When stop switch is pressed.	Possible to re-start after reset.
E052		Thread breakage detection error When thread breakage is detected.	Possible to re-start after reset.
A201		Needle replacing time warning When number of stitches of operation is reached to number of stitches of needle replacement that is set from the panel.	Possible to re-start after reset.
A202		Cleaning time warning When operation time of the sewing machine is reached to the cleaning time that is set from the panel.	Possible to re-start after reset.

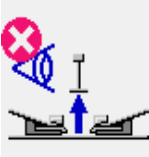
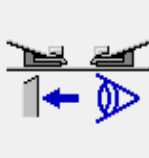





Error code		Description of error	How to recover
A203		<p>Oil replacement time warning When operation time of the sewing machine is reached to the oil replacement time that is set from the panel.</p>	Possible to re-start after reset.
E220		<p>Grease-up warning When number of stitches of operation is reached to 40 million stitches.</p>	Possible to re-start after reset.
E221		<p>Grease-up error When number of stitches of operation is reached to 48 million stitches, a sewing impossible state occurs. * After applying grease, it is possible to release when clearing memory switch U245 Number of stitches of grease-up.</p>	Possible to re-start after rest.
E303		<p>Semilunar plate sensor error Detection of upper dead point of the sewing machine cannot be performed.</p>	Turn OFF the power.
E349		<p>Step-out detection sensor does not react. For the emergency procedure, it is possible to continually use by re-starting with the reset button. However, check the sensor and be sure to replace it when it is defective.</p>	Possible to re-start after rest.
E366		<p>Center knife does not lower.</p>	Possible to re-start after rest.
E367		<p>Corner knife cannot be entered. In case of MO04 the long and wide type, corner knife cannot be entered when the corner knife opening amount exceeds 250 mm.</p>	Possible to re-start after rest.
E368		<p>Zipper has run out.</p>	Possible to re-start after rest.
E369		<p>Roller stacker lower end sensor does not detect.</p>	Possible to re-start after rest.
E370		<p>Roller stacker lower end sensor is gone past.</p>	Possible to re-start after rest.

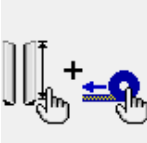
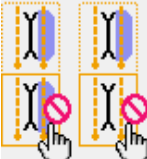
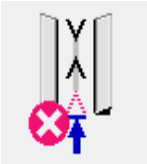
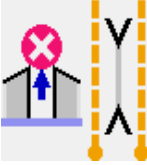
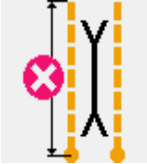
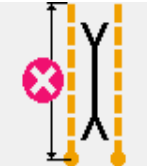
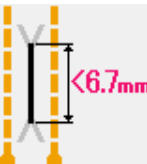
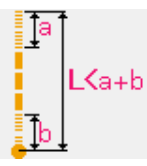

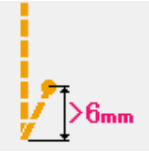

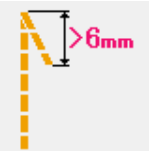

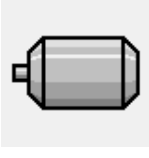
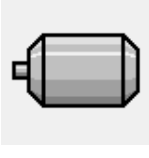
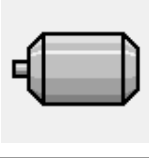
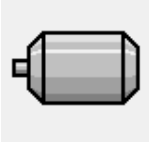

Error code		Description of error	How to recover
E371		Clamp bar stacker material presser sensor is gone past.	Possible to re-start after rest.
E372		Clamp bar stacker material sweeper origin sensor is gone past.	Possible to re-start after rest.
E373		Reflecting tape on right-hand side is deteriorated.	Possible to re-start after rest.
E374		Reflecting tape on leftt-hand side is deteriorated.	Possible to re-start after rest.
E376		Pedal continuous depressing error	Possible to re-start after rest.
E377		Center knife upper detection sensor cannot detect.	Possible to re-start after rest.
E378		Clamp bar stacker open detection	Possible to re-start after reset.
E379		Roller stacker lift sensor cannot detect.	Possible to re-start after reset.
E380		Flap sensor cannot receive light	Possible to re-start after reset.
E381		Flap rear end cannot be detected (forced stop). Error is displayed after end of sewing.	Possible to re-start after reset.

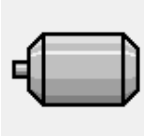

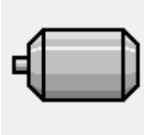
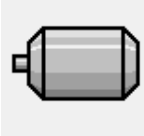
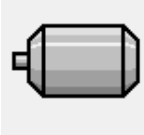
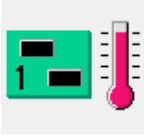

Error code		Description of error	How to recover
E382		Flap dust detection error	Possible to re-start after reset.
E383		Flap front end cannot be detected.	Possible to re-start after reset.
E386		Corner knife fixing side bottom detection error	Possible to re-start after reset.
E387		Corner knife fixing side top detection error	Possible to re-start after reset.
E388		Corner knife moving side bottom detection error	Possible to re-start after reset.
E389		Corner knife moving side top detection error	Possible to re-start after reset.
E390		Material sensor error Material remains after end of stacker operation.	Automatic recovery by sensor input
E391		ST material presser lift detection error	Automatic recovery by sensor input
E392		ST material sweeper origin detection error	Automatic recovery by sensor input
E393		Binder bottom detection error	Automatic recovery by sensor input

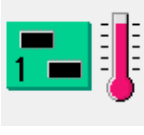
Error code		Description of error	How to recover
E394		Binder top detection error	Automatic recovery by sensor input
E398		Corner knife drawer detection error	Possible to re-start after reset.
E399		Binder open detection error	Possible to re-start after reset.
E401		Copy disapproved When trying to perform overwriting copy on the pattern No. which has been already registered	Possible to recover with CANCEL button
E402		Erasing disapproved When trying to delete the pattern used in the cycle sewing	Possible to recover with CANCEL button
E403		New creation disapproved When the registered pattern is selected to the new creation pattern No.	Possible to recover with CANCEL button
E404		Data of designated No. does not exist. When data of designated No. does not exist in media or server	Possible to recover with CANCEL button
E435	---	Erasing disapproved When trying to erase pattern registered to direct pattern.	Possible to re-start after reset.
E484		Zipper attaching data cannot be sewn.	Possible to re-start after reset.
E485		Data other than zipper attaching data cannot be sewn.	Possible to re-start after reset.

Error code		Description of error	How to recover
E486		Flap sewing data cannot be sewn.	Possible to re-start after reset.
E487		Both long presser and endless zipper are simultaneously selected.	Possible to re-start after reset.
E488	---	The gauge size exceeds the input range.	Possible to re-start after reset.
E489		Combination data other than right/left flap sewing is set at the time of flap priority setting of alternate sewing mode.	Possible to re-start after reset.
E490		It is not possible to feed up to corner knife position. When flap is put on this side in case of the long type	Possible to re-start after reset.
E491		Corner knife length is too short. When knife cannot be entered since the interval of corner knife is short.	Possible to re-start after reset.
E492		L size length is too short. When sewing cannot be performed since the inputted L size length is too short	Possible to re-start after reset.
E493		L size length is too long. When sewing cannot be performed since the inputted L size length is too long.	Possible to re-start after reset.
E494		Center knife length error When center knife length is smaller than knife size of 6.7 mm	Possible to re-start after reset.
E495		Length at sewing start/ending over When sewing length is shorter than the total of length of each condensation (back tack) at sewing start and sewing end	Possible to re-start after reset.

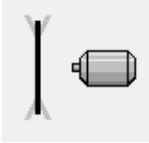
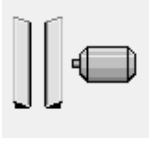
Error code		Description of error	How to recover
E496		Condensation at sewing end length over When condensation pitch X number of stitches exceeds 15.0 mm	Possible to re-start after reset.
E497		Back tack at sewing end length over When back tack pitch X number of stitches exceeds 6.0 mm	Possible to re-start after reset.
E498		Condensation at sewing start length over When condensation pitch X number of stitches exceeds 15.0 mm	Possible to re-start after reset.
E499		Back tack at sewing end length over When back tack pitch X number of stitches exceeds 6.0 mm	Possible to re-start after reset.
E702		CPU runaway detection When program abnormality has occurred in CPU	Turn OFF the power.
E703		Panel is connected to the sewing machine which is not supposed (Machine type error) When the machine type between panel and sewing machine is different in the initial communication	Possible to re-start after reset.
E704		Inconsistency of system version When system software version is inconsistent in the initial communication	Turn OFF the power.
E730		Main shaft motor is defective or lacking for phases. When encoder of sewing machine motor is abnormal	Turn OFF the power.
E731		Main motor hole sensor is defective or position sensor is defective. When hole sensor of sewing machine motor or position sensor is defective	Turn OFF the power.
E733		Reverse rotation of main shaft motor When the sewing machine motor rotates in the reverse direction	Turn OFF the power.
E802		Power momentary cut detection When input power is momentarily cut	Turn OFF the power.

Error code		Description of error	How to recover
E811		Overvoltage of power error When input power is more than the specified value	Turn OFF the power.
E813		Low voltage of power error When input power is less than the specified value	Turn OFF the power.
E901		Main shaft motor IPM abnormality When SERVO CONTTROL circuit board is abnormal	Turn OFF the power.
E903		Stepping motor power (50V) abnormality When stepping motor power of SERVO CONTROL circuit board fluctuates more than $\pm 15\%$	Turn OFF the power.
E904		Solenoid power (33V) abnormality When solenoid power of SERVO CONTROL circuit board fluctuates more than $\pm 15\%$	Turn OFF the power.
E905		Heat sink temperature for SERVO CONTROL circuit board abnormality Turn ON the power again after taking time.	Turn OFF the power.
E915		Communication abnormality between operation panel and MAIN CPU When abnormality occurs in data communication	Turn OFF the power.
E916		Communication abnormality between MAIN CPU and main shaft CPU When abnormality occurs in data communication	Turn OFF the power.
E917		Communication abnormality between operation panel and personal computer When abnormality occurs in data communication	Possible to re-start after reset.
E918		MAIN circuit board heat sink temperature abnormality Turn ON the power again after taking time.	Turn OFF the power.
E943		Defective EEP-ROM of MAIN CPU When data writing to EEP-ROM cannot be performed	Turn OFF the power.

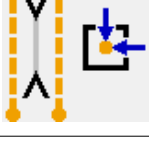
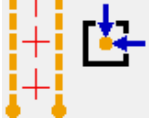
Error code		Description of error	How to recover
E983		Center knife motor lock detection	Turn OFF the power.
E984		Center knife motor abnormality	Turn OFF the power.
E985		Clamp foot motor step-out error	Possible to re-start after reset.
E986		Clamp foot stepping motor origin retrieval error	Possible to re-start after reset.
E987		Back tack motor origin retrieval error	Possible to re-start after reset.
E988		Pocket bag flap detecting motor origin-retrieval error	Possible to re-start after reset.
E992		Corner knife motor origin-retrieval error	Possible to re-start after reset.
E998		Corner knife stepping motor origin retrieval error	Possible to re-start after reset.
E999		Marking light motor origin retrieval error	Possible to re-start after reset.

13. INPUT NUMBER TABLE

Name	Connecting connector No.
Air pressure detection	MAIN CN-30
Origin sensor on marking light fine adjustment side	MAIN CN-36-6
Corner knife motor origin sensor	MAIN CN-37-7
Back tack motor origin sensor	MAIN CN-38-6
Thread breakage detection (left)	INTA CN62A-2
Thread breakage detection (right)	INTA CN63A-2
Material sensor	INTA CN65A-3
Clamp foot step-out detection	INTA CN66A-3
Binder open detection	INTA CN68A-1
Binder up detection	INTA CN71A-3
Marking light origin sensor	INTA CN75A-2
Clamp foot origin detection	INTA CN77A-2
Center knife lift detection	INTA CN79A-1
Flap sensor (left)	INTB CN60B-2
Flap sensor (right)	INTB CN61B-2
Corner knife drawer detection switch	INTB CN62B-2
Bobbin thread remaining amount detection (left)	INTB CN64B-2
Bobbin thread remaining amount detection (right)	INTB CN64B-5
Start switch	INTB CN65B-3
Temporary stop switch	INTB CN69B-1
Pedal volume sensor	INTB CN75B-2
Corner knife fixing side bottom detection	INTB CN79B-1
Corner knife fixing side top detection	INTB CN80B-1
Corner knife moving side bottom detection	INTB CN81B-1
Corner knife moving side top detection	INTB CN82B-1
Roller lift detection	INTB CN83A-19
Stacker open detection	INTB CN83B-13
Stacker origin	INTB CN83B-15