

# Operation Manual

## Sewing Machine

Product Code: 888-N00/N02/N20/N22/N40/N42

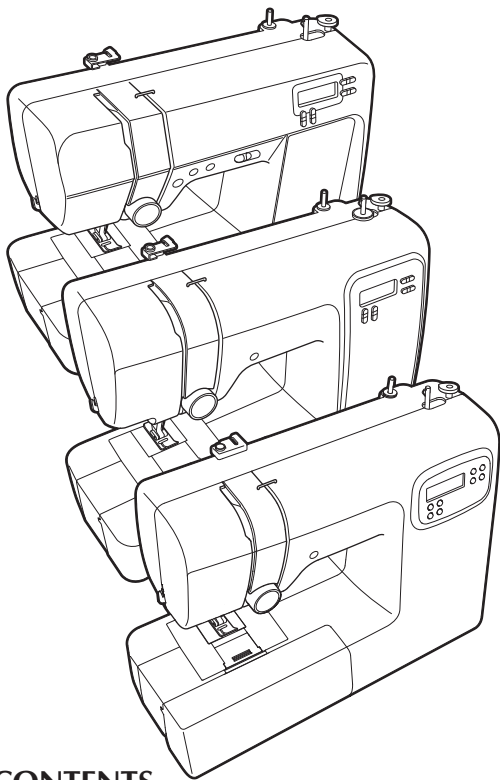

### CONTENTS

<b>IMPORTANT SAFETY INSTRUCTIONS</b> .....	2
<b>Names of Machine Parts</b> .....	4
Main parts.....	4
Needle and presser foot section.....	4
Operation buttons.....	4
Flat bed attachment.....	4
<b>Accessories</b> .....	5
Included accessories.....	5
Optional accessories.....	5
<b>Using Your Machine</b> .....	5
Power supply.....	6
Foot controller.....	6
Operation panel.....	6
Settings/Functions.....	6

<b>Threading the Machine</b> .....	7
Winding/Installing the bobbin.....	7
Upper threading.....	9
Drawing up the bobbin thread.....	11
<b>Fabric/Thread/Needle Combination</b> .....	12
<b>Needle</b> .....	13
Checking the needle.....	13
Replacing the needle.....	13
Sewing with the twin needle.....	13
<b>Replacing the Presser Foot</b> .....	14
Replacing the presser foot.....	14
Removing the presser foot holder.....	15
<b>Sewing Basics</b> .....	15
Selecting the stitch.....	15
Setting the stitch length and stitch width.....	15
Starting to sew.....	16
Sewing reverse/reinforcement stitches.....	16
Automatic reverse/reinforcement stitching.....	17
Thread tension.....	17
<b>Utility Stitches</b> .....	17
Overcasting stitches.....	17
Blind hem stitching.....	18
Buttonhole sewing.....	19
Button sewing (for models equipped with the button fitting foot "M").....	21
Zipper insertion.....	22
Bar tack stitching.....	23
<b>Making Adjustment</b> .....	23
<b>Brother Support Website Information (Downloading Manuals)</b> .....	24
<b>Care and Maintenance</b> .....	24
Restrictions on oiling.....	24
Precautions on storing the machine.....	24
Cleaning the machine surface.....	24
Cleaning the race.....	24
<b>Troubleshooting</b> .....	25
Frequent troubleshooting topics.....	25
Upper thread tightened up.....	25
Tangled thread on wrong side of fabric.....	25
Incorrect thread tension.....	26
Fabric is caught in the machine and cannot be removed.....	26
If the thread becomes tangled under the bobbin winder seat.....	28
List of symptoms.....	28
<b>Error Messages</b> .....	30
Operation beep.....	30
<b>Index</b> .....	31

Be sure to read this document before using the machine.

We recommend that you keep this document nearby for future reference.

# IMPORTANT SAFETY INSTRUCTIONS

Please read these safety instructions before attempting to use the machine.

## DANGER

- To reduce the risk of electrical shock

- 1** Always unplug the machine from the electrical outlet immediately after using, when cleaning, making any user servicing adjustments mentioned in this manual, or if you are leaving the machine unattended.

## WARNING

- To reduce the risk of burns, fire, electrical shock, or injury to persons.

- 2** Always unplug the machine from the electrical outlet when making any adjustments mentioned in the instruction manual.
  - To unplug the machine, switch the machine to the symbol "O" position to turn it off, then grasp the plug and pull it out of the electrical outlet. Do not pull on the cord.
  - Plug the machine directly into the electrical outlet. Do not use an extension cord.
  - Always unplug your machine if there is a power failure.
- 3** Electrical Hazards:
  - This machine should be connected to an AC power source within the range indicated on the rating label. Do not connect it to a DC power source or inverter. If you are not sure what kind of power source you have, contact a qualified electrician.
  - This machine is approved for use in the country of purchase only.
- 4** Never operate this machine if it has a damaged cord or plug, if it is not working properly, has been dropped or damaged, or water is spilled on the unit. Return the machine to the nearest authorized Brother dealer for examination, repair, electrical or mechanical adjustment.

- While the machine is stored or in use if you notice anything unusual, such as an odor, heat, discoloration or deformation, stop using the machine immediately and unplug the power cord.
- When transporting the machine, be sure to carry it by its handle. Lifting the machine by any other part may damage the machine or result in the machine falling, which could cause injuries.
- When lifting the machine, be careful not to make any sudden or careless movements, which may cause a personal injury.

- 5** Always keep your work area clear:

- Never operate the machine with any air openings blocked. Keep ventilation openings of the machine and foot controller free from the build up of lint, dust, and loose cloth.
- Do not store objects on the foot controller.
- Never drop or insert foreign objects in any opening.
- Do not operate where aerosol (spray) products are being used or where oxygen is being administered.
- Do not use the machine near a heat source, such as a stove or iron; otherwise, the machine, power cord or garment being sewn may ignite, resulting in fire or an electric shock.
- Do not place this machine on an unstable surface, such as an unsteady or slanted table, otherwise the machine may fall, resulting in injuries.

- 6** Special care is required when sewing:

- Always pay close attention to the needle. Do not use bent or damaged needles.
- Keep fingers away from all moving parts. Special care is required around the machine needle.
- Switch the machine to the symbol "O" position to turn it off when making any adjustments in the needle area.
- Do not use a damaged or incorrect needle plate, as it could cause the needle to break.
- Do not push or pull the fabric when sewing, and follow careful instruction when free motion stitching so that you do not deflect the needle and cause it to break.

- 7** This machine is not a toy:

- Your close attention is necessary when the machine is used by or near children.
- The plastic bag that this machine was supplied in should be kept out of the reach of children or disposed of. Never allow children to play with the bag due to the danger of suffocation.
- Do not use outdoors.

## 8 For a longer service life:

- When using and storing this machine, avoid direct sunlight and high humidity locations. Do not use or store the machine near a space heater, iron, halogen lamp, or other hot objects.
- Use only neutral soaps or detergents to clean the case. Benzene, thinner, and scouring powders can damage the case and machine, and should never be used.
- Always consult the Operation Manual when replacing or installing any assemblies, the presser feet, needle or other parts to assure correct installation.

## 9 For repair or adjustment:

- If the light unit is damaged, it must be replaced by an authorized Brother dealer.
- In the event a malfunction occurs or adjustment is required, first follow the troubleshooting table in the back of the Operation Manual to inspect and adjust the machine yourself. If the problem persists, please consult your local authorized Brother dealer.

**Use this machine only for its intended use as described in the manual.**

**Use accessories recommended by the manufacturer as contained in this manual.**

**The contents of this manual and specifications of this product are subject to change without notice.**

**For additional product information and updates, visit our website at [www.brother.com](http://www.brother.com)**

# SAVE THESE INSTRUCTIONS

**This machine is intended for household use.**

## FOR USERS IN COUNTRIES EXCEPT CENELEC COUNTRIES

This appliance is not intended for use by persons (including children) with reduced physical, sensory or mental capabilities, or lack of experience and knowledge, unless they have been given supervision or instruction concerning use of the appliance by a person responsible for their safety. Children should be supervised to ensure that they do not play with the appliance.

## FOR USERS IN CENELEC COUNTRIES

This appliance can be used by children aged from 8 years and above and persons with reduced physical, sensory or mental capabilities or lack of experience and knowledge if they have been given supervision or instruction concerning use of the appliance in a safe way and understand the hazards involved. Children shall not play with the appliance. Cleaning and user maintenance shall not be made by children without supervision.

## FOR USERS IN THE UK, EIRE, MALTA AND CYPRUS ONLY

### IMPORTANT

- In the event of replacing the plug fuse, use a fuse approved by ASTA to BS 1362, i.e. carrying the  mark, rating as marked on plug.
- Always replace the fuse cover. Never use plugs with the fuse cover omitted.
- If the available electrical outlet is not suitable for the plug supplied with this equipment, you should contact your authorized Brother dealer to obtain the correct lead.

## Names of Machine Parts

### Main parts

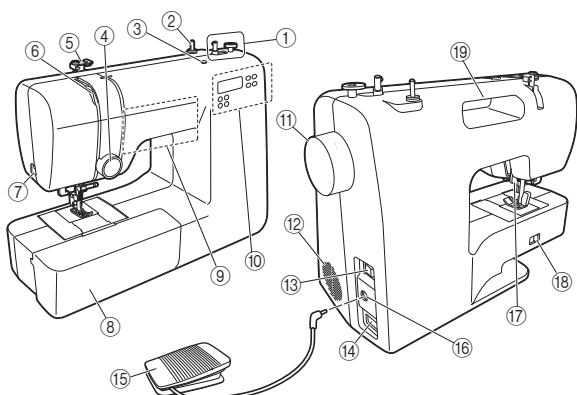

- ① Bobbin winder (page 8)
- ② Spool pin (page 7)
- ③ Hole for extra spool pin (page 14)
- ④ Thread tension dial (page 17)
- ⑤ Thread guide (pages 8, 10)
- ⑥ Thread take-up lever (page 10)
- ⑦ Thread cutter (page 16)
- ⑧ Flat bed attachment with accessory compartment (page 4)
- ⑨ Operation buttons (page 2)
- ⑩ Operation panel (page 6)
- ⑪ Handwheel  
This is used to manually raise and lower the needle.
- ⑫ Air vent  
This vent allows the air surrounding the motor to circulate. Do not cover the air vent while the machine is being used.
- ⑬ Main power switch (page 6)
- ⑭ Power supply jack (page 6)
- ⑮ Foot controller (page 6)
- ⑯ Foot controller jack (page 6)
- ⑰ Presser foot lever (pages 8, 9, 16)
- ⑱ Feed dog position switch (page 21)
- ⑲ Handle  
Carry the machine by its handle.

### Needle and presser foot section

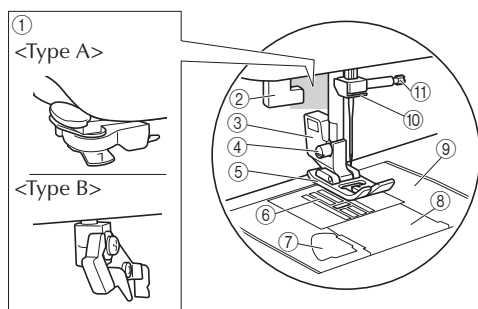

- ① Needle threader (page 10) ★
- ② Buttonhole lever (page 20) ★
- ③ Presser foot holder (page 15)
- ④ Presser foot holder screw (page 15)
- ⑤ Presser foot  
The presser foot applies pressure consistently on the fabric as the sewing takes place. Attach the appropriate presser foot for the selected stitching.
- ⑥ Feed dogs  
The feed dogs feed the fabric in the sewing direction.
- ⑦ Quick-set bobbin (page 11) ★
- ⑧ Bobbin cover (page 8)
- ⑨ Needle plate  
The needle plate is marked with guides for sewing straight seams.
- ⑩ Needle bar thread guide (page 10)
- ⑪ Needle clamp screw

### Operation buttons

The operation buttons differ depending on the machine model.

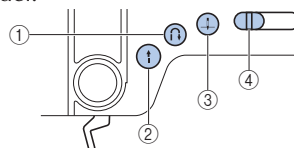

- ① Reverse/Reinforcement stitch button (↔) (page 16)  
Reverse stitches are sewn by keeping this button pressed down to sew in the opposite direction.
- ② "Start/Stop" button (↑) ★  
Press this button to start or stop sewing.
- ③ Needle position button (↓) ★  
Press this button to raise or lower the needle. Pressing the button twice sews one stitch.
- ④ Sewing speed controller ★  
Slide this controller to adjust the sewing speed. The controller also sets the maximum sewing speed of the foot controller.

### Flat bed attachment

Accessories such as presser foot, bobbins, and needles can be stored inside the flat bed attachment.

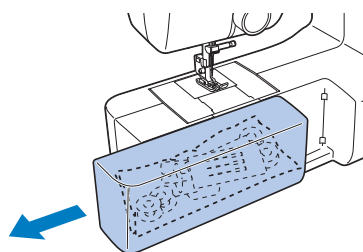

Slide the attachment to the left to open it.

#### Note

- Before storing accessories inside the flat bed attachment, put accessories in a kind of zipper plastic bags. If accessories are not in a bag, they may fall out, and be lost or damaged.

## Accessories

### Included accessories

For the included accessories and their part codes for your machine, refer to the additional sheet “Included Accessories”.

### Optional accessories

The following are available as optional accessories to be purchased separately.

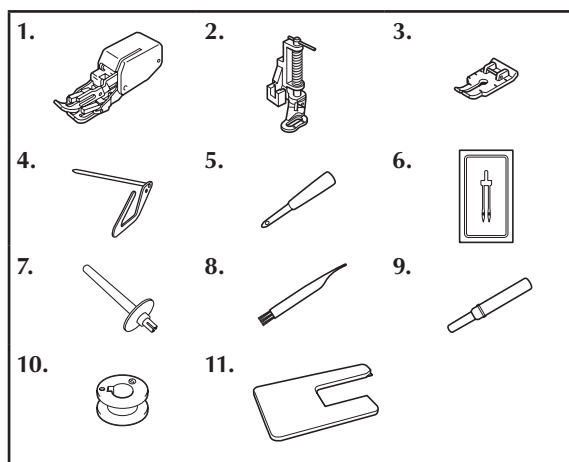

No.	Part Name	Part Code		
		Americas	Europe	China Others
1	Walking foot	SA140	F033N: XG6623-001	F033CN F033N
2	Quilting foot	SA129	F005N: XC1948-052	- F005N
3	1/4" piecing foot	SA125	F001N: XC1944-052	F001CN F001N
4	Quilting guide	SA132	F016N: XC2215-052	F016CN F016N
5	Eyelet punch		XG7791-001	
6	Twin needle (2/11 needle)		X59296-121	
7	Extra spool pin		XG3488-001	
8	Cleaning brush		X59476-051	
9	Seam ripper		XZ5082-001	
10	Bobbin	SA156	SFB: XA5539-151	- SFB
11	Wide table	SAWT7	WT17: D01LFJ-001	WT17CN WT17AP

### Memo

- To obtain optional accessories or other accessories available, contact your authorized Brother dealer or visit our site <http://s.brother/cpkg/>. Always use accessories recommended for this machine.

## Using Your Machine

### ⚠ WARNING

- Use only regular household electricity for the power source. Using other power sources may result in fire, electric shock, or damage to the machine.
- Make sure that the power plugs are firmly inserted into the electrical outlet and the power supply jack on the machine. Otherwise, a fire or electric shock may result.
- Do not insert the power plug into an electrical outlet that is in poor condition.
- Turn off the main power and remove the plug in the following circumstances:
  - When you are away from the machine
  - After using the machine
  - When the power fails during use
  - When the machine does not operate correctly due to a bad connection or a disconnection
  - During electrical storms

### ⚠ CAUTION

- Use the power cord included with this machine.
- Do not use extension cords or multi-plug adapters with many other appliances plugged in to them. Fire or electric shock may result.
- Do not touch the plug with wet hands. Electric shock may result.
- When unplugging the machine, always turn off the main power first. Always grasp the plug to remove it from the outlet. Pulling on the cord may damage the cord, or lead to fire or electric shock.
- Do not allow the power cord to be cut, damaged, modified, forcefully bent, pulled, twisted, or bundled. Do not place heavy objects on the cord. Do not subject the cord to heat. These may damage the cord and cause fire or electric shock. If the cord or plug is damaged, take the machine to your authorized dealer for repairs before continuing use.
- Unplug the power cord if the machine is not to be used for a long period of time. Otherwise a fire may result.
- (For U.S.A. only)  
This appliance has a polarized plug (one blade wider than the other). To reduce the risk of electrical shock, this plug is intended to fit in a polarized electrical outlet only one way.  
If the plug does not fit fully in the electrical outlet, reverse the plug. If it still does not fit, contact a qualified electrician to install the proper electrical outlet. Do not modify the plug in any way.

## Power supply

### 1 Insert the plug into a household electrical outlet.

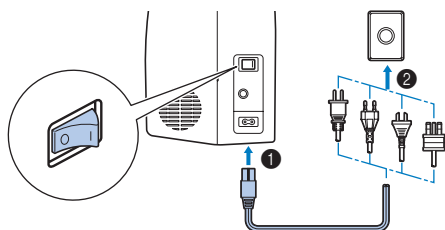

### 2 Turn on the machine.

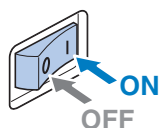

Press the "I" mark on the main power switch to turn on the main power, sewing light, and LCD.

To turn off the machine, press the "O" mark on the main power switch.

- ▶ The machine will make a sound. This is not a malfunction.

## Foot controller

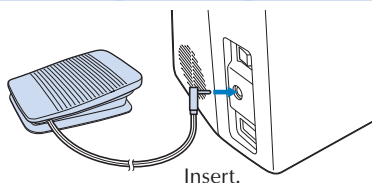

## CAUTION

- When inserting the foot controller plug, be sure to turn off the machine in order to prevent the machine from accidentally being started.

Slowly depress the foot controller to start sewing, and adjust the sewing speed by changing the pressing force.

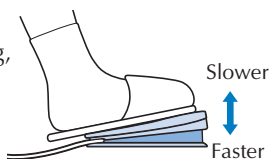

### Note

- (For U.S.A. only)  
Foot controller: Model T  
This foot controller can be used on the machine with product code 888-N00/N02/N20/N22/N40/N42. The product code is mentioned on the machine rating plate.
- When the foot controller is connected, ⓘ ("Start/Stop" button) is disabled. ★

## Operation panel

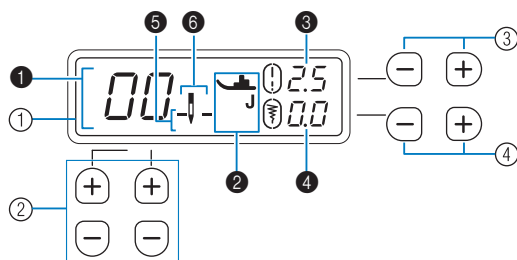

#### ① LCD (Liquid crystal display)

The selected stitch (1), presser foot that should be used (2), stitch length in millimeters (3), stitch width in millimeters (4), needle stop position (5), and single/twin needle mode (6) are displayed.

#### ② Stitch selection keys (page 15)

Press keys to change the stitch pattern.

#### ③ Stitch length keys (page 15)

Press keys to change the stitch length of the selected stitch pattern.

#### ④ Stitch width keys (page 15)

Press keys to change the stitch width of the selected stitch pattern.

## Settings/Functions

You can change settings of the following functions. The settings are stored even when the power switch is turned off.

No.	Function
1	Needle stop position
2	Initial needle position (left / middle (center))
3	Operation beep ★
4	Maximum sewing speed
5	Automatic reverse / reinforcement stitching
6	Needle mode (single needle / twin needle)
7	Stitch adjustment ★

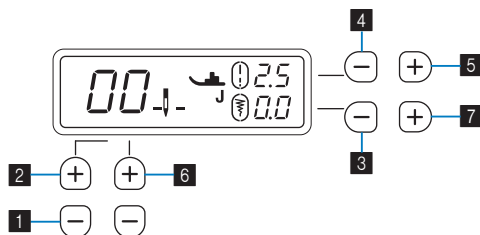

### 1 Changing the needle stop position

You can change the needle stop position to either the lowered (in the fabric) or raised position. (Default: Lowered position)

#### 1 Turn off the machine.

#### 2 Holding down 1, turn on the machine.



#### 3 After the machine has turned on, release 1.



- ▶ The needle stop position is changed.

↓ : Lowered position    ↑ : Raised position

★: Only for some models.

## 2 Changing the initial needle position

You can change the stitch selected when the machine is turned on to either  "straight stitch (left needle position)" or  "straight stitch (middle (center) needle position)". (Default: )



- 1 Turn off the machine.
- 2 Holding down , turn on the machine.
- 3 After the machine has turned on, release .

▶ The initial needle position is changed.

The currently selected stitch can be confirmed by the stitch number in the LCD.

## 3 Turning on/off the operation beep ★

You can turn on/off the operation beep. (Default: On)



- 1 Turn off the machine.
- 2 Holding down , turn on the machine.
- 3 After the machine has turned on, release .

▶ The operation beep setting is changed.

## 4 Changing the maximum sewing speed

You can change the maximum sewing speed to either the standard or slower speed. (Default: Standard speed mode)

When the slower speed mode is selected, the maximum speed adjusted with the sewing speed controller becomes slower. ★

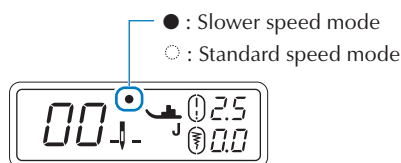

- 1 Turn off the machine.
- 2 Holding down , turn on the machine.
- 3 After the machine has turned on, release .

▶ The maximum sewing speed is changed.



## 5 Turning on/off the automatic reverse/reinforcement stitching

You can set the machine to automatically sew reverse or reinforcement stitches at the beginning and end of stitching. (Default: Off)

- 1 Turn off the machine.
- 2 Holding down , turn on the machine.
- 3 After the machine has turned on, release .

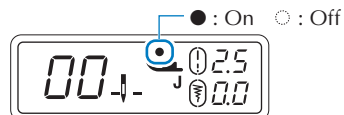

▶ The automatic reverse/reinforcement stitching is turned on or off.



\* For details, refer to "Automatic reverse/reinforcement stitching" (page 17).

## 6 Changing the needle mode

You can change the needle mode to either the single or twin needle mode. (Default: Single needle mode)

- 1 Turn off the machine.
- 2 Holding down , turn on the machine.
- 3 After the machine has turned on, release .



▶ The needle mode is changed.

 : Single needle mode  : Twin needle mode

\* For details, refer to "Sewing with the twin needle" (page 13).

## 7 Stitch adjustment ★

With some stitches, a stitch pattern may turn out poorly depending on the type of fabric. In such a case, you can make adjustments. (Default: 0)

- 1 Turn off the machine.
- 2 Holding down , turn on the machine.
- 3 After the machine has turned on, release .

▶ The machine turns into the stitch pattern adjustment mode.

\* For details, refer to "Making Adjustment" (page 23).

## Threading the Machine

### Winding/Installing the bobbin

## CAUTION

- Make sure the power is off while threading the machine. If you accidentally step on the foot controller and the machine starts to sew, you could be injured.
- Be sure to use the included bobbins (part code: SA156, SFB: XA5539-151) or the same type. SA156 is Class 15 type bobbin.

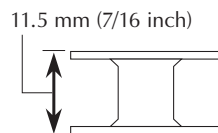

- 1 Pull up the spool pin as far as possible, and put a spool of thread on this pin.



Make sure that the thread unwinds as shown.

## CAUTION

- If the spool of thread is not in the right place, the thread may tangle on the spool pin.

- 2** Pass the thread under the thread guide and around the pretension disk, front to back.

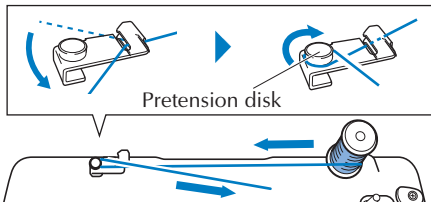

- 3** Passing the thread through a hole on the bobbin, set the bobbin on the bobbin winder shaft, and then slide the shaft to the right.

Make sure the notch fits the projection.

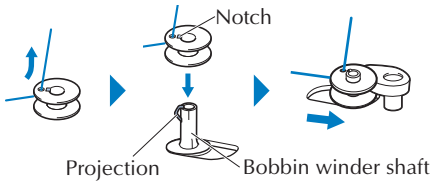

### Memo

- Checking the orientation of the bobbin will be helpful in later procedures. By placing the bobbin into the bobbin case in the same orientation that it was on the bobbin winder shaft, the bobbin can be installed with the correct winding direction of the bobbin thread.

The "b" mark on one side of the bobbin included with this machine can be used as a reference.

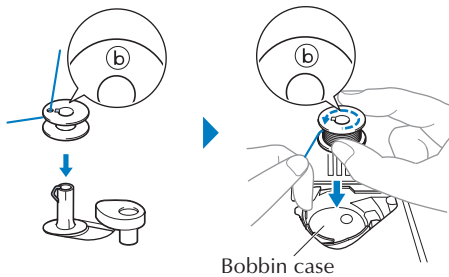

- 4** Turn on the machine.

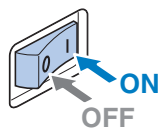

- 5** While holding the end of the thread, start the machine to wind the thread around the bobbin a few times.

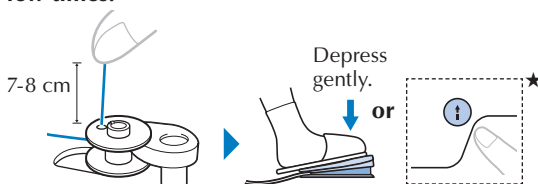

- 6** Stop the machine and trim the excess thread.

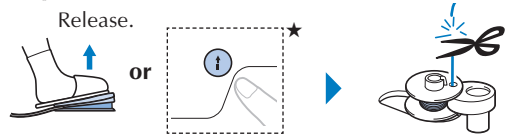

- 7** Slide the sewing speed controller to adjust the bobbin winding speed. ★

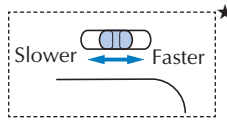

- 8** Start the machine.

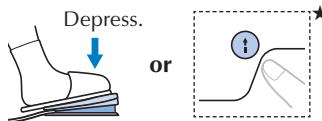

### Note

- We recommend winding stretch thread, such as transparent nylon thread, at a low speed since the thread may stretch.

- 9** When the bobbin seems full and begins spinning slowly, stop the machine.

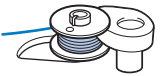

- 10** Cut the thread, slide the bobbin winder shaft to the left and remove the bobbin.

## CAUTION

- Make sure you follow the instructions carefully. If you do not cut the thread completely and the bobbin is wound, when the thread runs low, it may tangle around the bobbin and cause the needle to break.
- Not winding the bobbin properly may cause the thread tension to loosen, and may break the needle.



- 11** Raise the needle to its highest position, and then raise the presser foot lever.

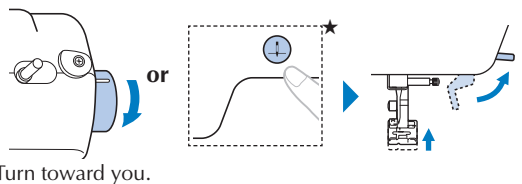

- 12** Turn off the machine.

- 13** Open the bobbin cover.

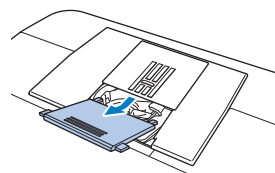

★: Only for some models.



- 14** Put the bobbin in, hold the end of the thread, push the bobbin down with your finger, and then pass the thread through the slit as shown.

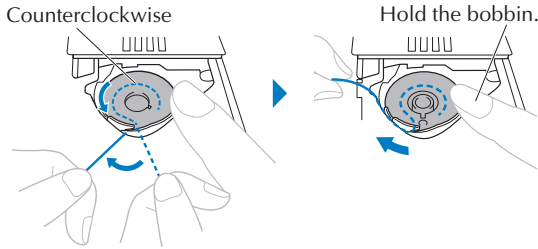

\* Follow this instruction so that the thread is correctly inserted through the tension spring of the bobbin case.

**□ For models equipped with the quick-set bobbin ★**

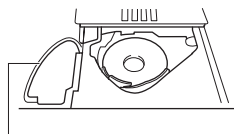

Slit for the quick set bobbin

Feed the end of the thread through the slit, and then pull the thread to cut it.

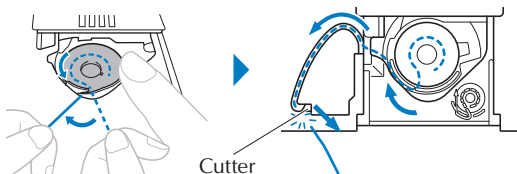

- \* The thread feeding direction is indicated by arrows on the needle plate.
- ▶ You can begin sewing without drawing up the bobbin thread before sewing, refer to "Drawing up the bobbin thread" (page 11).

## ⚠ CAUTION

- Be sure to hold down the bobbin with your finger and unwind the bobbin thread correctly, otherwise the thread may break or the thread tension will be incorrect.

- 15** Reattach the bobbin cover.

\* Make the end of the thread come out from the left side of the cover.

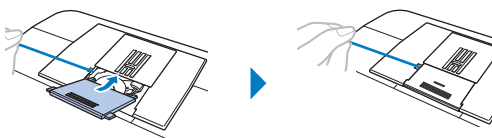

★: Only for some models.

### ■ For models equipped with the cutter ★

- 1** Follow steps **1** to **2** of "Winding/Installing the bobbin".

- 2** Set the bobbin on the bobbin winder shaft, and then slide the shaft to the right.

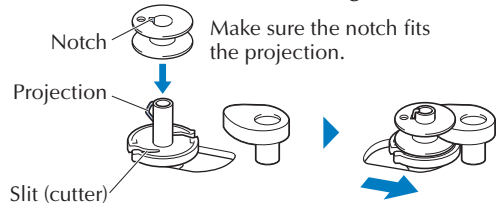

\* Check the installation orientation of the bobbin by using the "b" mark on one side of the bobbin as a reference. When placing the bobbin in the bobbin case, be sure to place it in the same orientation.

- 3**

Wind five or six times.

Pull the thread.

The thread is cut at the slit.

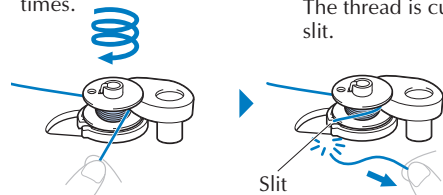

## ⚠ CAUTION

- Be sure to cut the thread as described. If the bobbin is wound without cutting the thread using the cutter built into the slit in the bobbin winder seat, the thread may become tangled in the bobbin or the needle may bend or break when the bobbin thread starts to run out.

- 4** Turn on the machine.

- 5** Follow steps **7** to **15** of "Winding/Installing the bobbin".

### Upper threading

## ⚠ CAUTION

- Make sure you thread the machine properly. Otherwise, the thread could tangle and break the needle.
- Never use a thread weight of 20 or lower.
- Use the needle and the thread in the correct combination. (page 12)

- 1** Raise the presser foot lever.

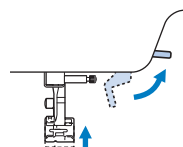



b) While lowering the needle threader lever fully (1), hook the thread onto the guide (2). Next, push back the needle threader lever until it stops (3), and pass the thread in front of the needle. Make sure that the thread is under the hook that has come through the eye of the needle and the hook catches the thread. (4).

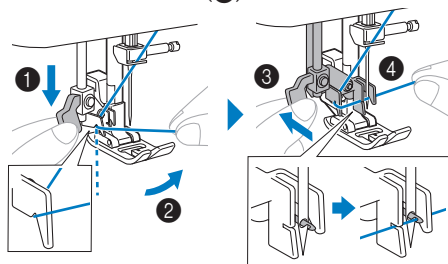

3 Return the needle threader lever to the front slowly, and then release the lever slowly.

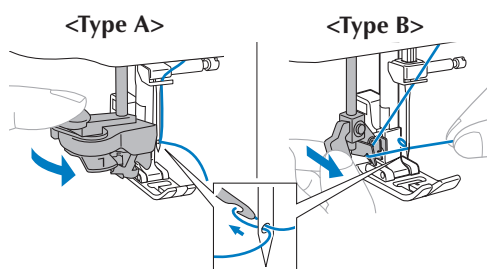

4 Raise the presser foot lever.

5 Pull the loop of the thread, and pass the end of the thread as illustrated below.

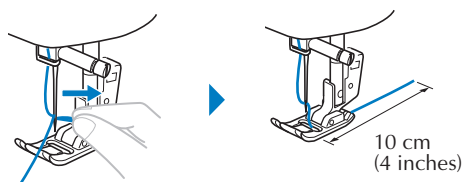

## Drawing up the bobbin thread

- 1 Refer to "Upper threading" (page 9) to thread the machine with the upper thread and thread the needle.
- 2 Follow steps 11 to 13 of "Winding/Installing the bobbin" (page 7) for installing the bobbin and to insert the bobbin into the bobbin case.
- 3 Pass the thread along the slit in the direction of the arrow, and leave it there without cutting it.



4 Lightly hold the end of the upper thread.

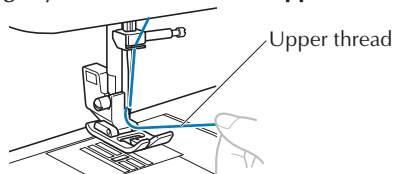

5 While holding the end of the upper thread, lower and raise the needle to draw up the bobbin thread.

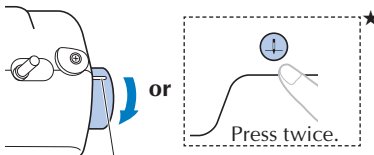

Turn towards you one full turn until this mark points up to the highest position.

6 Pull on the upper thread to draw up the bobbin thread.

Next, pull out about 10 cm (4 inches) of both threads toward the back under the presser foot.

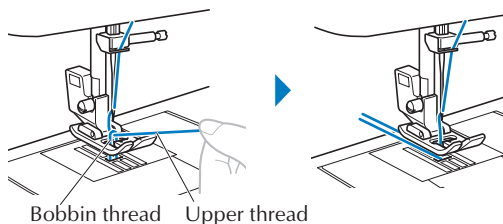

### For models equipped with the quick-set bobbin ★

You can begin sewing without drawing up the bobbin thread. (page 9)

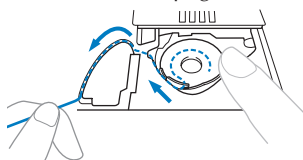

### Note

- When you sew gathers or finish up the threads at the beginning of sewing, draw up the bobbin thread.

★: Only for some models.

## Fabric/Thread/Needle Combination

- **Needles that can be used with this machine:** Home sewing machine needles (size 65/9 - 100/16)
  - \* The larger the number, the larger the needle. As the numbers decrease, the needles get finer.
- **Thread that can be used with this machine:** 30 - 90 weight
  - \* Never use thread of 20 weight or lower. It may cause machine to malfunction.
  - \* The smaller the number, the heavier the thread. As the numbers increase, the thread gets finer.
- **The machine needle and thread that should be used depends on the type and thickness of the fabric. Refer to the following table when choosing the thread and needle appropriate for the fabric that you wish to sew.**
  - The combinations shown in the table provide a general guideline. Be sure to sew trial stitches on the actual number of layers and type of fabric to be used in your project.
  - The machine needles are consumables. For safety and best results, we recommend replacing the needle regularly. For details on when to replace the needle, refer to "Checking the needle" (page 13).
- **In principle, use a fine needle and thread with lightweight fabrics, and a larger needle and heavier thread with heavyweight fabrics.**
- **Select a stitch appropriate for the fabric, and then adjust the stitch length. When sewing lightweight fabrics, make the stitch length finer (shorter). When sewing heavyweight fabrics, make the stitch length coarser (longer).** (page 15)
 

When sewing stretch fabrics, refer to "Sewing guide" (<http://s.brother/cmkg/>).

Fabric Type/Application		Thread		Size of needle	Stitch length mm (inch)
		Type	Weight		
Lightweight fabrics	Lawn, georgette, challis, organdy, crepe, chiffon, voile, gauze, tulle, lining, etc.	Polyester thread	60 - 90	65/9 - 75/11	Fine stitches 1.8 - 2.5 (1/16 - 3/32)
		Cotton thread, Silk thread	50 - 80		
Medium weight fabrics	Broadcloth, taffeta, gabardine, flannel, seersucker, double gauze, linen, terry cloth, waffle weave, sheeting, poplin, cotton twill, satin, quilting cotton, etc.	Polyester thread	60 - 90	75/11 - 90/14	Regular stitches 2.0 - 3.0 (1/16 - 1/8)
		Cotton thread, Silk thread	50 - 60		
Heavyweight fabrics	Denim (12 ounces or more), canvas, etc.	Polyester thread, Cotton thread	30	100/16	Coarse stitches 2.5 - 4.0 (3/32 - 3/16)
	Denim (12 ounces or more), canvas, tweed, corduroy, velour, melton wool, vinyl-coated fabric, etc.	Polyester thread	60	90/14 - 100/16	
		Cotton thread, Silk thread	30 - 50		
Stretch fabrics (knit fabrics, etc.)	Jersey, tricot, T-shirt fabric, fleece, interlock, etc.	Polyester thread, Cotton thread, Silk thread	50	Ball point needle 75/11 - 90/14	Setting appropriate for the fabric thickness
For top-stitching		Polyester thread, Cotton thread	30	90/14 - 100/16	Setting appropriate for the fabric thickness
			50 - 60	75/11 - 90/14	

### ■ Transparent nylon thread

Use a home sewing machine topstitching needle, regardless of the fabric or thread.

### ■ Sewing decorative stitch patterns (needles and threads) ★

When sewing lightweight, medium weight or stretch fabrics, use a ball point needle (gold colored) 90/14. When sewing heavyweight fabrics, use a home sewing machine needle 90/14.

In addition, #50 to #60 thread should be used.

## ⚠ CAUTION

- The appropriate fabric, thread and needle combinations are shown in the preceding table. If the combination of the fabric, thread and needle is not correct, particularly when sewing heavy fabrics (such as denim) with thin needles (such as 65/9 to 75/11), the needle may bend or break. In addition, the stitching may be uneven or puckered or there may be skipped stitches.

★: Only for some models.

## Needle

### ⚠ CAUTION

- Use recommended home sewing machine needles.
- Never use bent needles. Bent needles can easily break, possibly resulting in injuries.

## Checking the needle

Before using the needle, place the flat side of the needle on a flat surface and check that the distance between the needle and the flat surface is even.

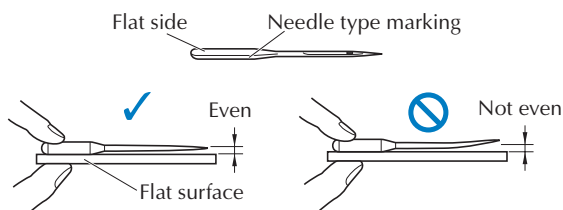

### Note

- The machine needles are consumables. Replace the needle in cases such as those described below.
  - If an unusual sound is produced when the needle enters the fabric. (The tip of the needle may be broken or dull.)
  - If stitches are skipped. (The needle may be bent.)
  - Generally, after completing one project, such as a piece of clothing.

## Replacing the needle

### ⚠ CAUTION

- Before replacing the needle, be sure to turn off the machine, otherwise injuries may occur if the foot controller (or ⚠ (“Start/Stop” button) ★) is accidentally pressed and the machine starts sewing.

### 1 Raise the needle to its highest position.

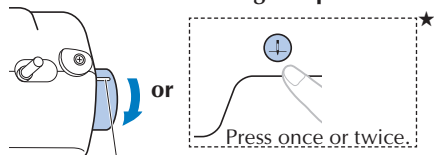

Turn toward you so that this mark points up to the highest position.

### 2 Remove the presser foot. (page 14)

- 3 Turn off the machine.
- 4 Before replacing the needle, cover the hole in the needle plate with fabric or paper to prevent the needle from falling into the machine.
- 5 Remove the needle.

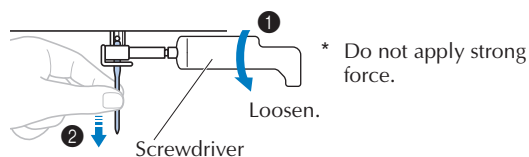

### 6 Install another needle.

Insert until the needle touches this part.

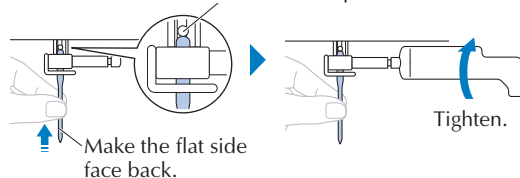

### 7 Attach the presser foot. (page 15)

### ⚠ CAUTION

- Be sure to install the needle as described above, otherwise the needle may break or damage may result.

## Sewing with the twin needle

You can sew with the twin needle and two upper threads. You can use the same color or two different colors of thread for making decorative stitches.



For details on the stitches that can be sewn with the twin needle, refer to “Stitch chart” (<http://s.brother/cmkg/>).

\* The twin needle and the extra spool pin are sold separately with some models.

### ⚠ CAUTION

- Use the twin needle that has been made for this machine (part code: X59296-121).
- Do not sew with bent needles. The needle could break and injure you.
- You cannot use the needle threader to thread the twin needle. Instead, thread the twin needle by hand, from front to back. Using the needle threader may damage the machine.

★: Only for some models.

# ⚠ CAUTION

- When using the twin needle, be sure to select an appropriate stitch, otherwise the needle may break or the machine may be damaged.
- Select a stitch width of 5.0 mm (3/16 inch) or less, otherwise the needle may break or the machine may be damaged.
- After adjusting the stitch width, slowly turn the handwheel toward you (counterclockwise) and check that the needle does not touch the presser foot. If the needle hits the presser foot, the needle may bend or break.
- When using the twin needle, be sure to attach zigzag foot “J”, otherwise the needle may break or the machine may be damaged.
- When changing the sewing direction, be sure to raise the needle before turning the fabric. If the fabric is turned while the needle is lowered, the needle may bend or break.

- 1 Attach zigzag foot “J”.
- 2 Attach the twin needle in the same way as a single needle. (page 13)
- 3 Put the extra spool pin in the hole on the top of the machine, and then put the second spool of thread onto the extra spool pin.

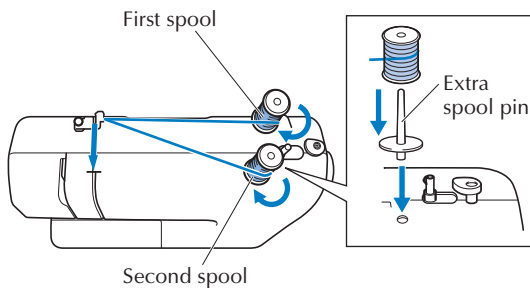

- 4 Thread the left needle by using the thread from the first spool in the same way as for normally threading the machine (for a single needle). (page 9)
  - \* Be sure to pass the thread behind the needle bar thread guide.
- 5 Thread the right needle by using the thread from the second spool in the same way as for normally threading the machine (for a single needle). (page 9)
  - \* Be sure to thread the right needle from front to back.

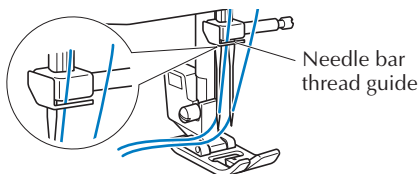

- 6 Turn the machine into the twin needle mode. (page 7)
- 7 Select a stitch and start sewing.
  - \* If you select an inappropriate stitch with the twin needle, an error message appears. Select an appropriate stitch.

## 💡 Note

- You cannot use the needle threader to thread the twin needle. Instead, thread the twin needle by hand, from front to back. Using the needle threader may damage the machine. ★

## Replacing the Presser Foot

# ⚠ CAUTION

- Before replacing the presser foot, be sure to turn off the machine, otherwise injuries may occur if the foot controller (or ⓘ (“Start/Stop” button) ★) is accidentally pressed and the machine starts sewing.
- Always use the correct presser foot for the stitch pattern you have chosen. If you use the wrong presser foot, the needle may strike the presser foot and bend or break, and may cause injury.
- Use the presser feet that have been designed to be used with this machine.

## Replacing the presser foot

- 1 Raise the needle to its highest position.

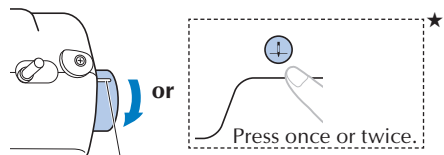

Turn toward you so that this mark points up to the highest position.

- 2 Turn off the machine, then raise the presser foot lever.
- 3 Remove the presser foot.
  - \* Refer to one of the procedure depending on the type of your machine.

Press the black button to release the presser foot.

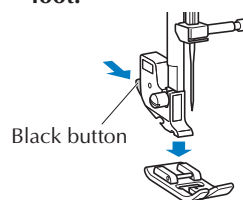

Pull the presser foot vertically downward.

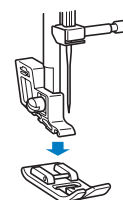

★: Only for some models.

- 4** Place another foot so that the groove and pin align.

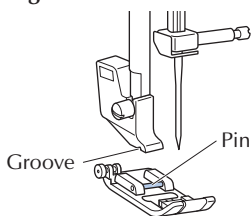

**Note**

- The presser foot to be used with each stitch appears in the LCD.

- 5** Slowly lower the presser foot lever so that the presser foot pin snaps into the groove.

### Removing the presser foot holder

Remove the presser foot holder when installing a presser foot that does not use the presser foot holder, such as the walking foot \* and quilting foot \*.

\* : Sold separately with some models.

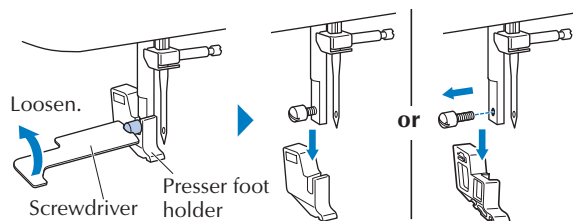

**Note**

- When attaching the presser foot holder, hold the presser foot holder in place and tighten the screw.

### Sewing Basics

## CAUTION

- While the machine is in operation, pay special attention to the needle location. In addition, keep your hands away from all moving parts such as the needle and handwheel, otherwise injuries may occur.
- Do not pull or push the fabric too hard while sewing, otherwise injuries may occur or the needle may break.
- Never use bent needles. Bent needles can easily break, possibly resulting in injuries.
- Make sure that the needle does not strike basting pins, otherwise the needle may break or bend.

### Selecting the stitch

Press the stitch selection keys to change the stitch number.

Selected stitch    Presser foot that should be used

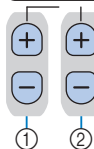
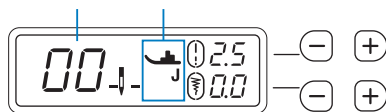

**Stitch selection keys**

- ① Changes the tens digit of the stitch number.
- ② Changes the ones digit of the stitch number.

### Setting the stitch length and stitch width

- Press + or - of the stitch length keys to increase or reduce the stitch length.

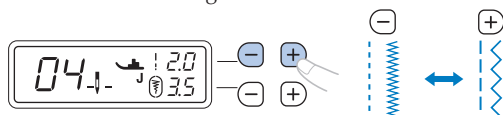

- Press + or - of the stitch width keys to increase or reduce the stitch width.

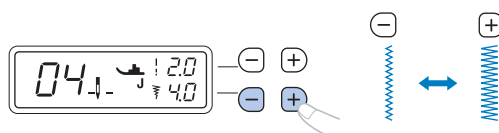

**Memo**

- If a straight stitch or triple stretch stitch is selected, changing the stitch width changes the needle position. Increasing the width moves the needle to the right; reducing the width moves the needle to the left.

**Note**

- The setting value changes until it reaches the maximum or minimum value.
- around or disappears when changed from the standard setting.
- If "--" appears to the right of , the stitch width cannot be adjusted.

# ⚠ CAUTION

- After adjusting the stitch width, slowly turn the handwheel toward you (counterclockwise) and check that the needle does not touch the presser foot. If the needle hits the presser foot, the needle may bend or break.
- If the stitches are bunched together, increase the stitch length. Continuing to sew with the stitches bunched together may result in the needle bending or breaking.

## Starting to sew

Baste the fabric before starting to sew.

### 1 Raise the needle to its highest position.

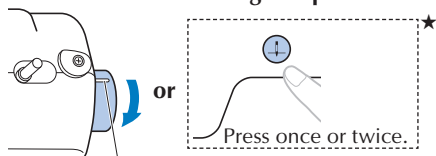

Turn toward you so that this mark points up to the highest position.

### 2 Raise the presser foot lever.

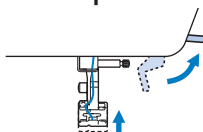

### 3 Set the fabric under the presser foot, and then hold the fabric and the end of the thread with your left hand.

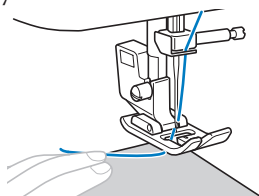

### 4 Lower the needle to the starting point of the stitching.

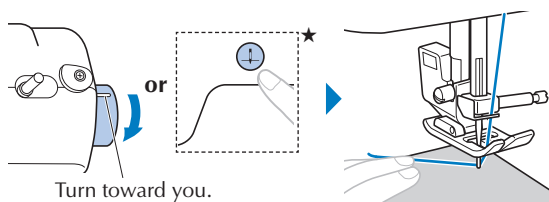

### 5 Lower the presser foot lever.

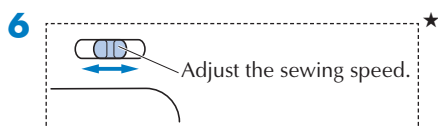

### 7 Start sewing.

\* Guide the fabric lightly by hand.

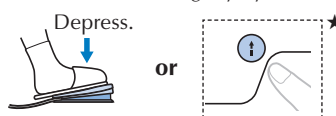

### 8 Stop sewing.

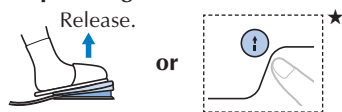

### 9 Raise the needle, and then raise the presser foot lever.

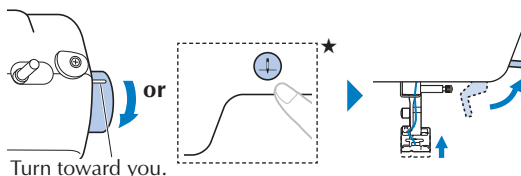

### 10 Pull the fabric and cut the threads.

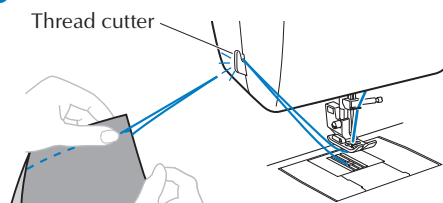



## Sewing reverse/reinforcement stitches

Reverse/reinforcement stitches are generally necessary at the beginning and end of sewing.

With reinforcement stitches, 3 to 5 stitches are sewn at the same place. With reverse stitches, the stitching is sewn in the opposite direction.

Depending on the selected stitch, reverse or reinforcement stitches are sewn while  (Reverse/Reinforcement stitch button) is pressed continuously.

### Memo

- When any of the reverse stitch patterns is selected, pressing  (Reverse/Reinforcement stitch button) will sew reverse stitches. When any other stitch is selected, pressing  (Reverse/Reinforcement stitch button) will sew reinforcement stitches.

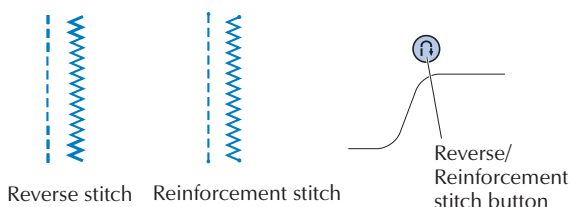
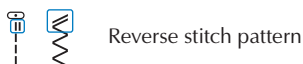



## Automatic reverse/reinforcement stitching

Turn on the automatic reverse/reinforcement stitching function before sewing, and the machine will automatically sew reinforcement stitches (or reverse stitches, depending on the stitch pattern) at the beginning and end of sewing.

- 1 Turn on the automatic reverse/reinforcement stitching. (page 7)
- 2 Select a stitch.
- 3 Set the fabric in the start position and start sewing.

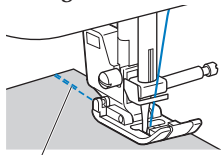

Reverse stitches (or reinforcement stitches)

- ▶ The machine will automatically sew reverse stitches (or reinforcement stitches) and then continue sewing.

### Note

- You can pause or resume sewing by pressing (Start/Stop button) while sewing. ★

- 4 Once you have reached the end of the stitching, press (Reverse/Reinforcement stitch button).

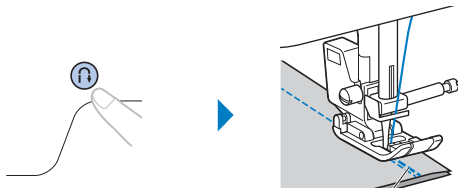

Reverse stitches (or reinforcement stitches)

- ▶ The machine will sew reverse stitches (or reinforcement stitches) and stop.

## Thread tension

The thread tension will affect the quality of your stitches. You may need to adjust it when you change fabric or thread.

### Note

- We recommend that you do a test sample on scrap of a fabric before you start to sew.

### Correct tension

- \* Too much or too little tension will weaken your seams or cause puckers on your fabric.

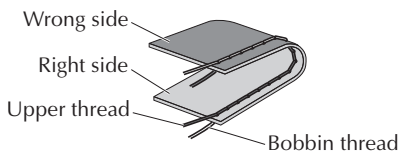

★: Only for some models.

### Upper tension is too tight

#### Note

- If the bobbin thread was incorrectly threaded, the upper thread may be too tight. In this case, refer to “Winding/Installing the bobbin” (page 7) and rethread the bobbin thread.

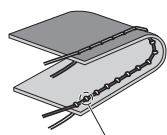

Loops will appear on the right side of the fabric.

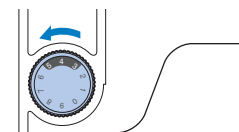

**Solution**  
Reduce the upper thread tension.

### Upper tension is too loose

#### Note

- If the upper thread was incorrectly threaded, the upper thread may be too loose. In this case, refer to “Upper threading” (page 9) and rethread the upper thread.

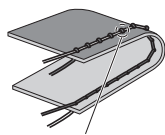

Loops appear on the wrong side of the fabric.

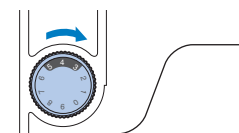

**Solution**  
Increase the upper thread tension.

#### Note

- If the upper thread is not threaded correctly or the bobbin is not installed correctly, it may not be possible to set the correct thread tension. If the correct thread tension cannot be achieved, rethread the upper thread and insert the bobbin correctly.

## Utility Stitches

You can see the “Stitch chart” from “<http://s.brother/cmkg/>”.

## Overcasting stitches

Sew overcasting stitches along the edges of cut fabric to prevent them from fraying.

- 1 Attach overcasting foot “G”.



- 2 Select a stitch.



- \* Stitches may differ depending on the model. Check stitch selections on the machine's body, and then select the stitch number.

# CAUTION

- When using overcasting foot "G", be sure to select a stitch that can be used with overcasting foot "G". If you sew with the incorrect stitch, the needle may hit the presser foot, bending the needle or damaging the presser foot.

- 3** Position the fabric with the edge of the fabric against the presser foot guide, and then lower the presser foot lever.

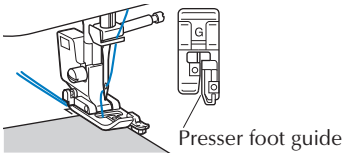

- 4** Rotate the handwheel toward you (counterclockwise). Check that the needle does not touch the presser foot.

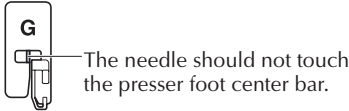

- 5** Sew with the edge of the fabric against the presser foot guide.

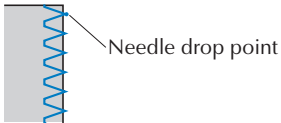

# CAUTION

- Be sure to pull the fabric backward after finished sewing. If you pull the fabric toward side or forward, the presser foot pin may be damaged.
- If thread is tangled on the presser foot, remove the entangled thread, and then raise the presser foot lever to remove the presser foot. If the presser foot is raised while entangled with thread, the presser foot may be damaged.

- 6** Stop sewing when you are finished, and raise the presser foot and needle to pull the fabric under the presser foot towards the back of the machine.

## Blind hem stitching

Secure the lower edge of skirts and pants with a blind hem.

### Memo

- When the size of cylindrical pieces is too small to slide onto the arm or the length is too short, the fabric will not feed and desired results may not be achieved.

- 1** Turn the skirt or pants inside out.

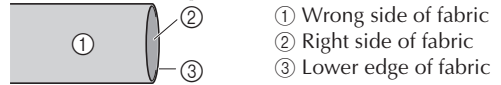

- 2** Fold the lower edge of fabric to the desired length to be hemmed and then press.

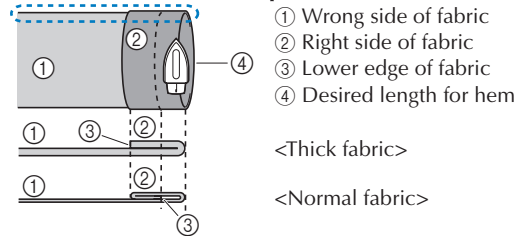

<Seen from the side>

- 3** Using tailor's chalk, mark the fabric about 5 mm (3/16 inch) from the edge of the fabric, and then baste it.

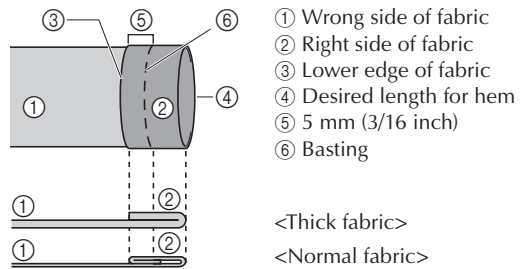

<Seen from the side>

- 4** Fold back the fabric inside along the basting.

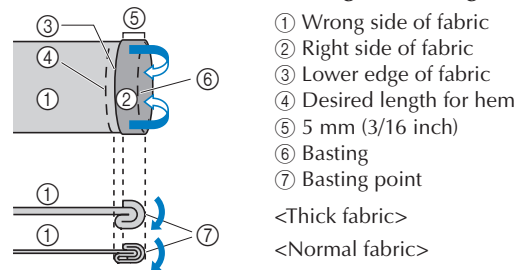

<Seen from the side>

- 5** Unfold the edge of fabric, and position the fabric with the wrong side facing up.

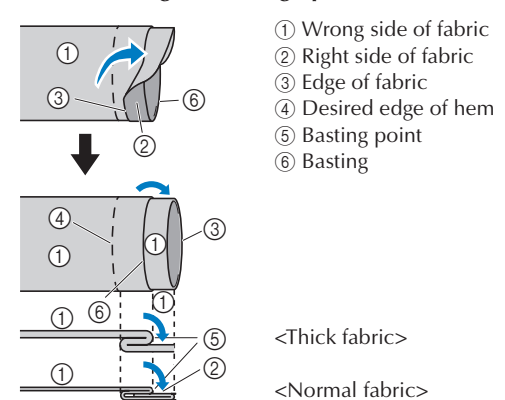

<Seen from the side>

**6** Attach blind stitch foot “R”.



**7** Select a stitch.



\* Stitches may differ depending on the model. Check stitch selections on the machine's body, and then select the stitch number.

**8** Remove the flat bed attachment to use the free arm.

**9** Slide the item that you wish to sew onto the free arm, make sure that the fabric feeds correctly, and then start sewing.

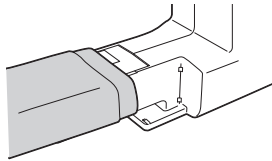

**10** Position the fabric with the edge of the folded hem against the presser foot guide, and then lower the presser foot lever.

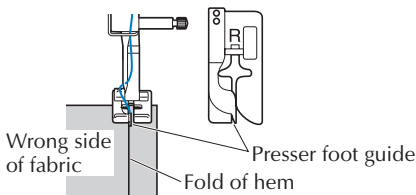

**11** Adjust the stitch width until the needle slightly catches the fold of the hem. (page 15)

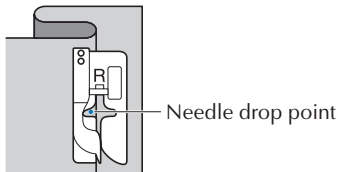

When you change the needle drop point, raise the needle, and then change the stitch width.

\* To make fine adjustments to the needle drop point, adjust the stitch width setting.

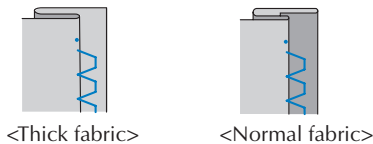

**Memo**

- Blind hem stitches cannot be sewn if the left needle drop point does not catch the fold. If the needle catches too much of the fold, the fabric cannot be unfolded and the seam appearing on the right side of the fabric will be very large, leaving an unattractive finish.

**12** Sew with the fold of the hem against the presser foot guide.

**13** Stop sewing when you are finished, and raise the presser foot and needle to pull the fabric under the presser foot towards the back of the machine.

**Note**

- Be sure to pull the fabric towards the back of the machine after sewing. If you pull the fabric toward side or forward, the presser foot may be damaged.

**14** Remove the basting stitching and turn the fabric with the right side facing out.

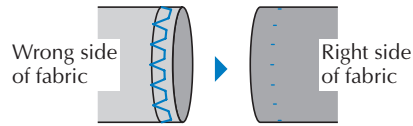

**Buttonhole sewing**

The maximum buttonhole length is about 28 mm (1-1/8 inches) (diameter + thickness of the button). Buttonholes are sewn from the front of the presser foot to the back, as shown below.

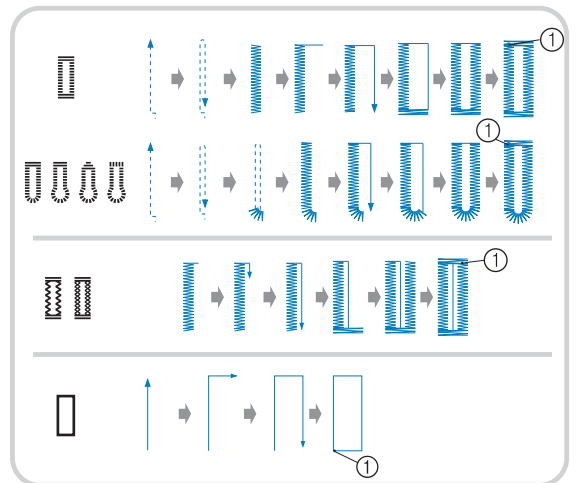

① Reinforcement stitching

\* Stitches may differ depending on the model. Check the stitches lineup on your machine's body, and then select the stitch number.

The part names of buttonhole foot “A”, which is used to create buttonholes, are indicated below.

- ① Button guide plate
- ② Presser foot scale
- ③ Presser foot pin
- ④ Marks on buttonhole foot
- ⑤ 5 mm (3/16 inch)

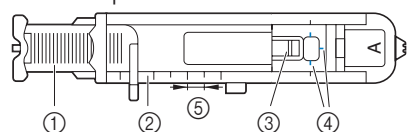

**Note**

- Before sewing buttonholes, check the stitch length and width by sewing a trial buttonhole on a scrap piece of fabric used for your project.

**1 Use chalk to mark on the fabric the position and length of the buttonhole.**

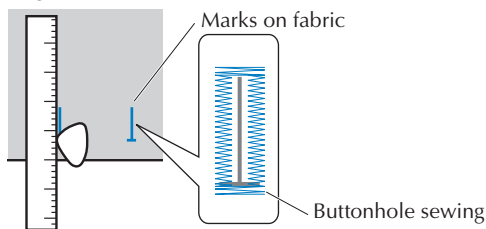

**2 Pull out the button guide plate of buttonhole foot "A", and then insert the button that will be put through the buttonhole.**

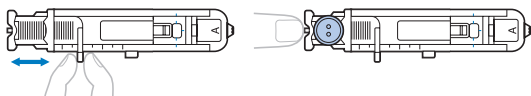

**\* If the button does not fit in the button guide plate**

Add together the diameter and thickness of the button, and then set the button guide plate to the calculated length.

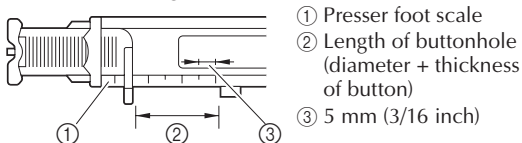

Example: For a button with a diameter of 15 mm (9/16 inch) and a thickness of 10 mm (3/8 inch), the button guide plate should be set to 25 mm (1 inch) on the scale.

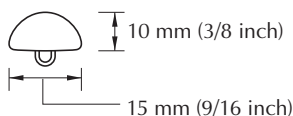

► The size of the buttonhole is set.

**3 Attach buttonhole foot "A".**

Before attaching the buttonhole foot "A", pass the upper thread underneath the presser foot through the hole.

**4 Select a stitch.**

\* Stitches may differ depending on the model. Check stitch selections on the machine's body, and then select the stitch number.

**5 Position the fabric with the front end of the buttonhole mark aligned with the red marks on the buttonhole foot, and then lower the presser foot lever.**

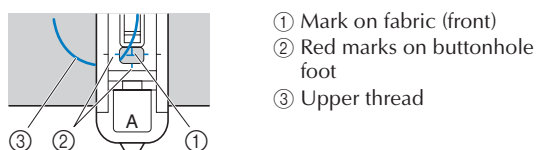

**Note**

- When lowering the presser foot, do not push in the front of the presser foot, otherwise the bar tack will not be sewn with the correct size.

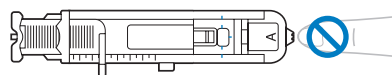

**6 Pull down the buttonhole lever as far as possible.**

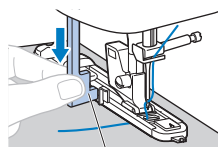

Buttonhole lever

The buttonhole lever is positioned behind the bracket on the buttonhole foot.

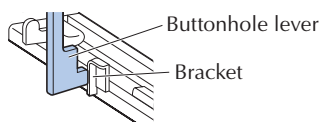

**7 Gently hold the end of the upper thread in your left hand, and then start sewing.**

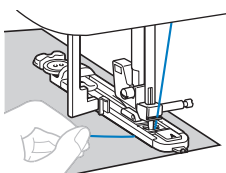

► Once sewing is completed, the machine automatically sews reinforcement stitches, then stops.

**8 Raise the needle and presser foot, then remove the fabric, and then cut the threads.**

**9 Raise the buttonhole lever to its original position.**

**10 Insert a pin along the inside of one bar tack at the end of the buttonhole stitching to prevent the stitching from being cut.**

**11 Use the seam ripper to cut towards the pin and open the buttonhole.**

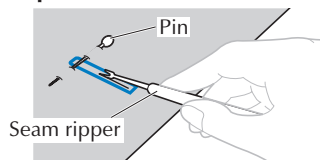

For keyhole buttonholes, use the eyelet punch to make a hole in the rounded end of the buttonhole, and then use the seam ripper to cut open the buttonhole.

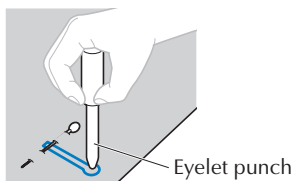

\* When using the eyelet punch, place thick paper or some other protective sheet under the fabric before punching the hole in the fabric.

## ⚠ CAUTION

- When opening the buttonhole with the seam ripper, do not place your hands in the cutting direction, otherwise injuries may result if the seam ripper slips.
- Do not use the seam ripper in any other way than how it is intended.

### ■ Sewing buttonholes on stretch fabrics ★

(Available on models with 35 or more stitches.)

When sewing buttonholes on stretch fabrics, use a gimp thread.

- 1 Hook the gimp thread onto the part of buttonhole foot “A” shown in the illustration.

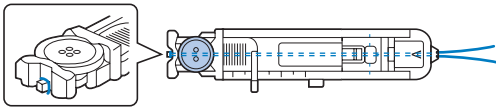

- 2 It fits into the grooves, and then loosely tie it.

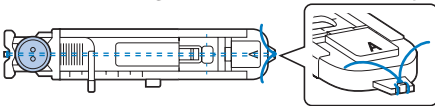

- 3 Attach buttonhole foot “A”.

- 4 Select a stitch. 

\* Stitches may differ depending on the model. Check stitch selections on the machine's body, and then select the stitch number.

- 5 Adjust the stitch width to the thickness of the gimp thread.

- 6 Lower the presser foot lever and the buttonhole lever, and then start sewing.

- 7 When sewing is finished, gently pull the gimp thread to remove any slack.

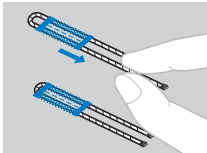

- 8 Use a handsewing needle to pull the gimp thread to the wrong side of the fabric, and then tie it.

### Button sewing (for models equipped with the button fitting foot “M”)

Buttons can be sewn on with the machine. Buttons with two or with four holes can be attached.

★: Only for some models.

- 1 Measure the distance between the holes in the button to be attached.



- 2 Raise the presser foot lever.

- 3 Slide the feed dog position switch, located at the rear of the machine on the base, to **▲▲**.

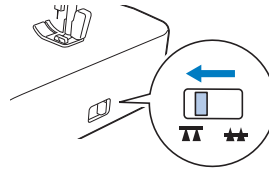

► The feed dogs are lowered.

- 4 Attach button fitting foot “M”.

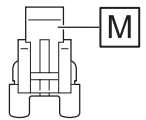

- 5 Select a stitch. 

\* Check the stitch number on the machine's body, and set the machine for that stitch.

- 6 Adjust the stitch width so that it is the same as the distance between the holes in the button.

- 7 Place the button in the position where it will be sewn, and lower the presser foot lever.

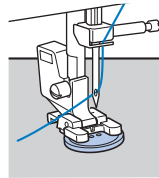

- When attaching four-hole buttons, first sew the two holes closest to you. Then, slide the button so that the needle goes into the two holes toward the rear of the machine, and then sew them in the same way.

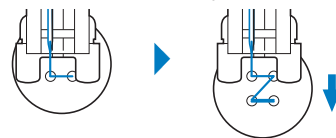

- 8 Turn the handwheel toward you (counterclockwise) to check that the needle correctly goes into the two holes of the button.

If it seems as if the needle will hit the button, remeasure the distance between the holes in the button. Adjust the stitch width to the distance between the button holes.

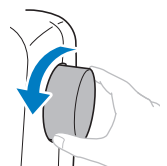

# CAUTION

- When sewing, be sure that the needle does not touch the button, otherwise the needle may bend or break.

- 9 Sew about 10 stitches at a slow speed.**  
Set the sewing speed controller to the left (so that the speed will be slow).

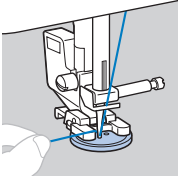

- 10 Use scissors to cut the upper thread and the bobbin thread at the beginning of the stitching.** Pull the upper thread at the end of the stitching to the wrong side of the fabric, and then tie it with the bobbin thread.

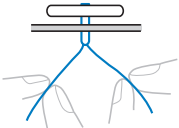

- 11 When you are finished attaching the button, slide the feed dog position switch, to  and turn the handwheel to raise the feed dogs.**

## Zipper insertion

### ■ Inserting a centered zipper

Stitching is sewn on both pieces of fabric butted against each other.

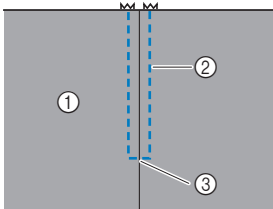

- 1 Right side of fabric
- 2 Stitching
- 3 End of zipper opening

- 1 Attach zigzag foot "J".**  
**2 Sew straight stitches up to the zipper opening.** With the right sides of the fabric facing each other, sew reverse stitches after reaching the zipper opening.

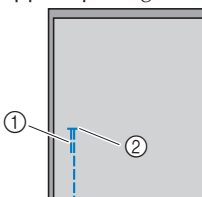

- 1 Reverse stitches
- 2 End of zipper opening

- 3 Baste the fabric from the zipper opening to the edge of the fabric.**

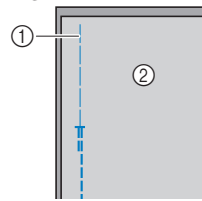

- 1 Basting stitching
- 2 Wrong side of fabric

- 4 Press open the seam allowance from the wrong side of the fabric.**

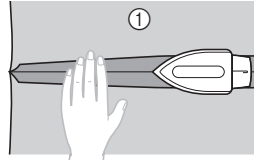

- 1 Wrong side of fabric

- 5 Align the seam with the center of the zipper, and then baste the zipper in place to the seam allowance.**

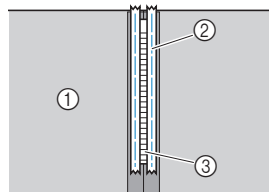

- 1 Wrong side of fabric
- 2 Basting stitching
- 3 Zipper

- 6 Remove about 5 cm (2 inches) from the end of the basting on the outside.**

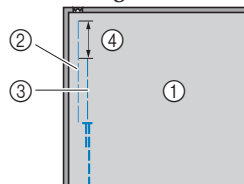

- 1 Wrong side of fabric
- 2 Zipper basting
- 3 Outside basting
- 4 5 cm (2 inches)

- 7 Attach the presser foot holder to the right pin of zipper foot "I".**

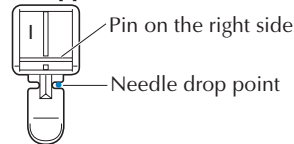

- 8 Select the straight stitch (  middle (center) needle position).**

\* Check the stitch number on the machine's body, and set the machine for that stitch.

# CAUTION

- When using zipper foot "I", be sure to select the straight stitch (middle (center) needle position), and slowly turn the handwheel toward you (counterclockwise) to check that the needle does not touch the presser foot. If a different stitch is selected or the needle hits the presser foot, the needle may bend or break.

## 9 Topstitch around the zipper.

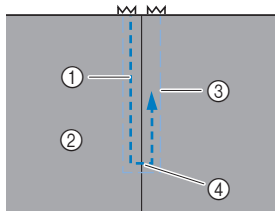

- ① Stitching
- ② Right side of fabric
- ③ Basting stitching
- ④ End of zipper opening

# CAUTION

- When sewing, be sure that the needle does not touch the zipper, otherwise the needle may bend or break.

### Memo

- If the presser foot contacts the zipper slider, leave the needle lowered (in the fabric) and raise the presser foot. After moving the slider so it will not contact the presser foot, lower the presser foot and continue sewing.

## 10 Remove the basting stitching.

### Bar tack stitching

(Available on models with 20 or more stitches.)

Bar tacks are used to reinforce points subject to strain, such as pocket corners and openings. As an example, the procedure for sewing bar tacks at pocket corners is described below.

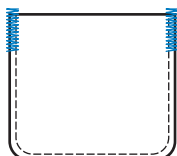

### 1 Determine the length of the bar tack.

Set the button guide plate on buttonhole foot "A" to the length of the bar tack. (The distance between the markings on the presser foot scale is 5 mm (3/16 inch).)

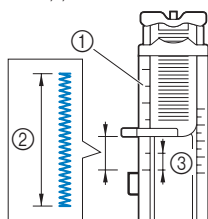

- ① Presser foot scale
- ② Length of bar tack
- ③ 5 mm (3/16 inch)

- A bar tack with a maximum length of about 28 mm (1-1/8 inches) can be sewn.

### 2 Attach buttonhole foot "A".

Before attaching the buttonhole foot "A", pass the upper thread underneath the presser foot through the hole.

### 3 Select a stitch.

- \* Check the stitch number on the machine's body, and set the machine for that stitch.

★: Only for some models.

- 4 Position the fabric so that the opening of the pocket faces toward you, and then lower the presser foot lever so that the needle drops 2 mm (1/16 inch) in front of the pocket opening.

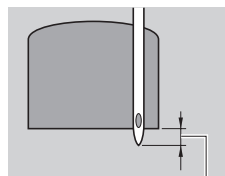

2 mm (1/16 inch)

- 5 Pull down the buttonhole lever as far as possible.

- 6 Gently hold the end of the upper thread in your left hand, and then start sewing.

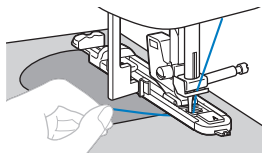

- 7 After sewing is finished, raise the presser foot lever, remove the fabric, and then cut the threads.

- 8 Raise the buttonhole lever to its original position.

## Making Adjustment

(Available on models with 25 or more stitches.)

Your stitch pattern may sometimes turn out poorly, depending on the type or thickness of fabric, the stabilizer material used, sewing speed, etc. If your sewing does not turn out well, sew trial stitches using the same conditions as the real sewing, and adjust the stitch pattern as explained below.

If the stitch pattern does not turn out well even after making adjustments based on the stitch pattern described below, make adjustments for each stitch pattern individually.

- 1 Change the display to the stitch adjustment display. (page 7)

- 2 Attach monogramming foot "N".

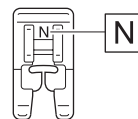

- 3 Adjust stitches with the stitch length keys.

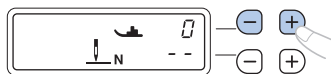

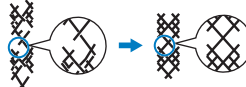
- If the stitch pattern is bunched: Press "+" several times. 
- If the stitch pattern has gaps: Press "-" several times. 

- 4 Sew the stitch pattern again.

- \* If the stitch pattern still comes out poorly, make adjustments again until the stitch pattern comes out correctly.

## Memo

- This adjustment can be made to  (Quilting stippling stitch), decorative stitches, satin stitches, and cross stitches. For details on the built-in stitch patterns, refer to "Stitch Chart" (<http://s.brother/cmkg/>).

## Brother Support Website Information (Downloading Manuals)

Brother support website introduces a variety of information about the product, such as sewing tips, how to use optional accessories, and details on stitch patterns.

Please visit us at <http://s.brother/cmkg/>.

You can download "Sewing Guide" and "Stitch Chart".

You can also download this Operation Manual from the site.

## Care and Maintenance

### Restrictions on oiling

In order to prevent damaging this machine, it must not be oiled by the user.

This machine was manufactured with the necessary amount of oil applied to ensure correct operation, making periodic oiling unnecessary.

If problems occur, such as difficulty turning the handwheel or an unusual noise, immediately stop using the machine, and contact your authorized Brother dealer or the nearest Brother authorized service center.

### Precautions on storing the machine

Do not store the machine in any of the locations described below, otherwise damage to the machine may result, for example, rust caused by condensation.

- Exposed to extremely high or low temperatures
- Exposed to extreme temperature changes
- Exposed to high humidity or steam
- Near a flame, heater or air conditioner
- Outdoors or exposed to direct sunlight
- Exposed to extremely dusty or oily environments

### Note

- In order to extend the life of this machine, periodically turn it on and use it. Storing this machine for an extended period of time without using it may reduce its efficiency.

## Cleaning the machine surface

### CAUTION

- Unplug the power supply cord before cleaning the machine, otherwise injuries or an electric shock may occur.

## Cleaning the race

Sewing performance will suffer if dust collects in the bobbin case.

### CAUTION

- Make sure you unplug the machine before you clean it. Otherwise, you may get an electric shock or be injured.

- 1 Turn off the machine and unplug the power cord.
- 2 Raise the needle and remove the presser foot.
- 3 Remove the needle (1) and the presser foot holder (2). Next, loosen the two screws (3) and remove the needle plate.

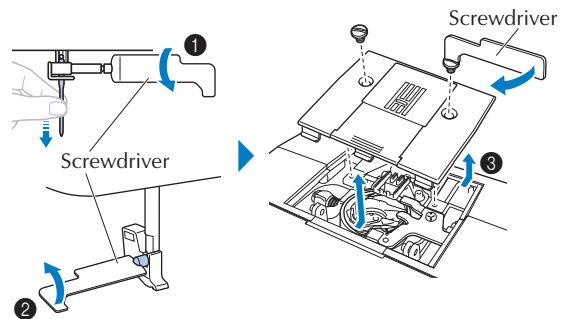

### Note

- Be careful not to drop the removed screws in the machine.

- 4 Remove the bobbin case, and remove any dust from the race and its surrounding area.

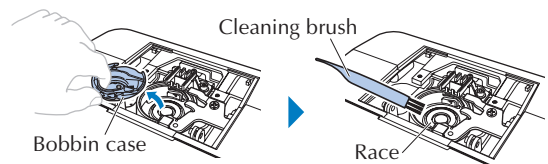

- \* Do not put oil on the bobbin case.

### Note

- Compressed can air is not recommended to be used.



- 5** Insert the bobbin case so that the ▲ and ● marks align.

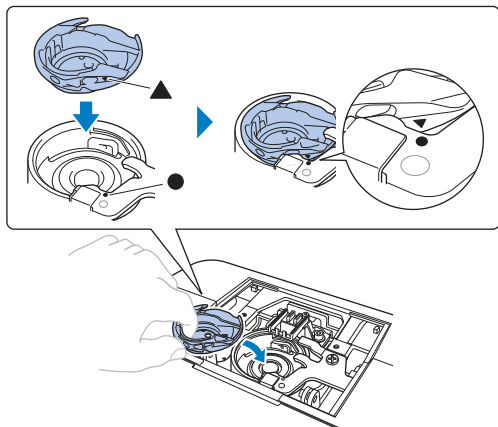

## ⚠ CAUTION

- Never use a bobbin case that is scratched, otherwise the upper thread may become tangled, the needle may break or sewing performance may suffer. For a new bobbin case, contact your nearest Brother authorized service center.
- Make sure that you fit the bobbin case properly, otherwise the needle may break.

- 6** Attach the needle plate, and then tighten the screws.

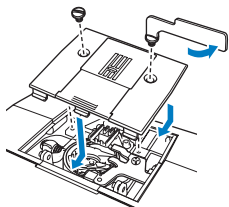

## Troubleshooting

If the machine stops operating correctly, check the following possible problems before requesting service. You can solve most problems by yourself. If you need additional help, the Brother support website offers the latest FAQs and troubleshooting tips. Visit us at "<http://s.brother/cpkag/>".

If the problem persists, contact your Brother dealer or the nearest Brother authorized service center.

## Frequent troubleshooting topics

Detailed causes and remedies for common troubleshooting topics are as follows. Be sure to refer to this before contacting us.

★: Only for some models.

Topic	Page
Upper thread tightened up	25
Tangled thread on wrong side of fabric	25
Incorrect thread tension	26
Fabric is caught in the machine and cannot be removed	26
If the thread becomes tangled under the bobbin winder seat ★	28

## Upper thread tightened up

### ■ Symptom

- The upper thread appears as a single continuous line.
- The bobbin thread is visible from the upper side of the fabric. (Refer to the illustration below.)
- The upper thread has tightened up, and comes out when pulled.
- The upper thread has tightened up, and wrinkles appear in the fabric.
- The upper thread tension is tight, and the results do not change even after the thread tension is adjusted.

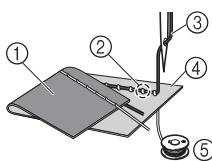

- ① Wrong side of fabric
- ② Bobbin thread visible from right side of fabric
- ③ Upper thread
- ④ Right side of fabric
- ⑤ Bobbin thread

### ■ Cause

#### Incorrect bobbin threading

If the bobbin thread is incorrectly threaded, instead of the appropriate tension being applied to the bobbin thread, it is pulled through the fabric when the upper thread is pulled up. For this reason, the thread is visible from the right side of the fabric.

### ■ Remedy/check details

Correctly install the bobbin thread. (page 9)

## Tangled thread on wrong side of fabric

### ■ Symptom

- The thread becomes tangled on the wrong side of the fabric.

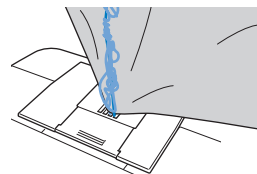

- After starting sewing, a rattling noise is made and sewing cannot continue.
- Looking under the fabric, there is tangled thread in the bobbin case.

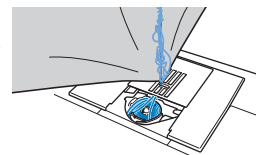

## ■ Cause

### Incorrect upper threading

If the upper thread is incorrectly threaded, the upper thread passed through the fabric cannot be firmly pulled up and the upper thread becomes tangled in the bobbin case, causing a rattling noise.

## ■ Remedy/check details

Remove the tangled thread, and then correct the upper threading.

### 1 Remove the tangled thread. If it cannot be removed, cut the thread with scissors.

\* For details, refer to "Cleaning the race" (page 24).

### 2 Remove the upper thread from the machine.

### 3 Correct the upper threading by following the instructions in "Upper threading" (page 9).

\* If the bobbin was removed from the bobbin case, refer to "Winding/Installing the bobbin" (page 7) to correctly install the bobbin.

## Incorrect thread tension

## ■ Symptoms

1. The bobbin thread is visible from the right side of the fabric. (Refer to the illustration below.)
2. The upper thread appears as a straight line on the right side of the fabric.
3. The upper thread is visible from the wrong side of the fabric. (Refer to the illustration below.)
4. The bobbin thread appears as a straight line on the wrong side of the fabric.
5. The stitching on the wrong side of the fabric is loose or has slack.

### □ Symptom 1

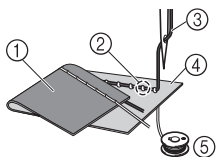

### □ Symptom 3

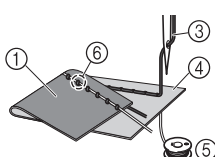

- ① Wrong side of fabric
- ② Bobbin thread visible from right side of fabric
- ③ Upper thread
- ④ Right side of fabric
- ⑤ Bobbin thread
- ⑥ Upper thread visible from wrong side of fabric

## ■ Cause/remedy/check details

### □ Cause 1

#### The machine is not correctly threaded.

<With symptoms 1 and 2 described above>

The bobbin threading is incorrect.

Return the thread tension dial to "4", and then refer to "Winding/Installing the bobbin" (page 7) to correct the threading.

<With symptoms 3 through 5 described above>

The upper threading is incorrect.

Return the thread tension dial to "4", and then

refer to "Upper threading" (page 9) to correct the upper threading.

### □ Cause 2

#### A needle and thread appropriate for the fabric are not being used.

The machine needle that should be used depends on the type of fabric sewn and the thread thickness.

If a needle and thread appropriate for the fabric are not being used, the thread tension will not be adjusted correctly, causing wrinkles in the fabric or skipped stitches.

\* Refer to "Fabric/Thread/Needle Combination" (page 12) to check that a needle and thread appropriate for the fabric are being used.

### □ Cause 3

#### An appropriate upper tension is not selected.

Select an appropriate thread tension.

Refer to "Thread tension" (page 17).

The appropriate thread tension differs depending on the type of fabric and thread being used.

\* Adjust the thread tension while test sewing on a piece of scrap fabric that is the same as that used in your project.

## 💡 Note

- If the upper threading and bobbin threading are incorrect, the thread tension cannot be adjusted correctly. Check the upper threading and bobbin threading first, and then adjust the thread tension.

- **If the bobbin thread is visible from the right side of the fabric**

Turn the thread tension dial counterclockwise to loosen the upper thread tension.

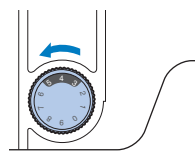

- **If the upper thread is visible from the wrong side of the fabric**

Turn the thread tension dial clockwise to tighten the upper thread tension.

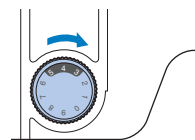

## Fabric is caught in the machine and cannot be removed

If the fabric is caught in the machine and cannot be removed, the thread may have become tangled under the needle plate. Follow the procedure described below to remove the fabric from the machine. If the operation cannot be completed according to the procedure, instead of attempting to remove it forcefully, contact your nearest Brother authorized service center.

## ■ Removing the fabric from the machine

**1** Immediately stop the machine.

**2** Turn off the machine.

**3** Remove the needle.

If the needle is lowered into the fabric, turn the handwheel away from you (clockwise) to raise the needle out of the fabric, and then remove the needle.

\* Refer to "Replacing the needle" (page 13).

**4** Remove the presser foot and presser foot holder.

If the thread is entangled on the presser foot, remove the entangled thread, and then raise the presser foot lever to remove the presser foot. Otherwise, the presser foot may be damaged.

\* Refer to "Replacing the presser foot" (page 14).

**5** Lift up the fabric and cut the threads below it.

If the fabric can be removed, remove it. Continue with the following steps to clean the race.

**6** Remove the needle plate cover.

\* Refer to "Cleaning the race" (page 24).

**7** Cut out the tangled threads, and then remove the bobbin.

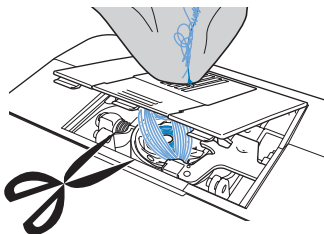

**8** Remove the bobbin case.

If threads remain in the bobbin case, remove them.

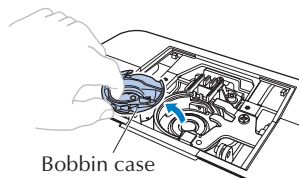

**9** Use the cleaning brush or a vacuum cleaner mini attachment to remove any lint or dust from the race and its surrounding area.

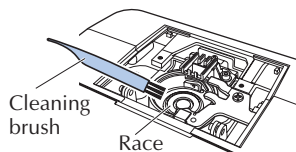

- If the fabric could be removed ➔ Continue to step **11**.
- If the fabric could not be removed ➔ Continue to step **10**.

### 💡 Note

- Compressed can air is not recommended to be used.

**10** Remove the fabric and threads from the needle plate.

If the fabric cannot be removed, even after completing these steps, contact your nearest Brother authorized service center.

**11** Insert the bobbin case by following step **5** in "Cleaning the race" (page 24).

**12** Attach the needle plate cover by following step **6** in "Cleaning the race" (page 24).

**13** Turn the handwheel to check that the feed dogs move smoothly and do not contact the edges of the slots in the needle plate.



- ① Correct position of feed dogs
- ② Incorrect position of feed dogs

**14** Check the condition of the needle, and then install it.

If the needle is in a poor condition, for example, if it is bent, be sure to install a new needle.

\* Refer to "Checking the needle" (page 13) and "Replacing the needle" (page 13).

### 📖 Memo

- Since the needle may have been damaged when the fabric was caught in the machine, we recommend replacing it with a new one.

## ■ Checking machine operations

If the needle plate has been removed, check machine operations to confirm that installation has been completed correctly.

**1** Turn on the machine.

**2** Select the straight stitch (  middle (center) needle position).

### 💡 Note

- Do not yet install the presser foot and thread.

**3** Slowly turn the handwheel toward you (counterclockwise), and look from all sides to check that the needle falls at the center of the opening in the needle plate.

If the needle contacts the needle plate, remove the needle plate, and then install it again, starting with step **13** in "Fabric is caught in the machine and cannot be removed" (page 27).

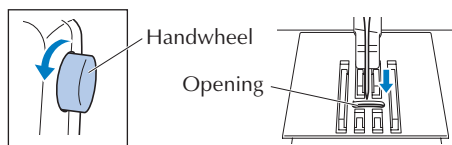

**4** Select stitch . At this time, increase the stitch length and width to their maximum settings.

\* For details on changing the settings, refer to "Setting the stitch length and stitch width" (page 15).

**5** Slowly turn the handwheel toward you (counterclockwise) and check that the needle bar and feed dogs operate correctly.

If the needle or feed dogs contact the needle plate, the machine may be malfunctioning; therefore, contact your nearest Brother authorized service center.

**6** Turn off the machine, and then install the bobbin and presser foot.

Never use a scratched or damaged presser foot. Otherwise, the needle may break, or sewing performance may suffer.

\* Refer to "Winding/Installing the bobbin" (page 7) and "Replacing the presser foot" (page 14).

**7** Correctly thread the machine.

\* For details on threading the machine, refer to "Upper threading" (page 9).

**8** Perform trial sewing with cotton fabric.

 **Note**

- Incorrect sewing may be the result of incorrect upper threading or sewing thin fabrics. If there are poor results from the trial sewing, check the upper threading or the type of fabric being used.

### If the thread becomes tangled under the bobbin winder seat ★

If the bobbin winding starts when the thread is not passed under the pretension disk of the thread guide correctly, the thread may become tangled under the bobbin winder seat.

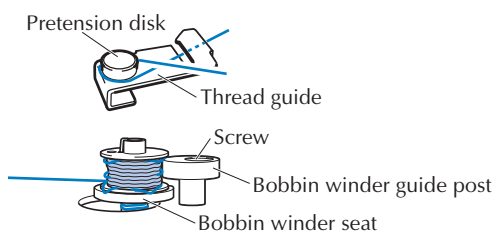

## ⚠ CAUTION

- Do not remove the bobbin winder seat even if the thread become tangled under the bobbin winder seat. Otherwise, the cutter in the bobbin winder seat may be damaged. (for models equipped with the cutter).
- Do not remove the screw on the bobbin winder guide post, otherwise the machine may be damaged; you cannot wind off the thread by removing the screw.

**1** Stop the bobbin winding.

**2** Cut the thread with scissors beside the thread guide.

**3** Slide the bobbin winder shaft to the left, and then remove the bobbin from the shaft and cut the thread leading to the bobbin in order to be able to completely remove the bobbin from the shaft.

**4** Hold the thread end with your left hand, and wind off the thread clockwise from under the bobbin winder seat with your right hand.

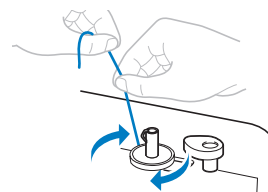

### List of symptoms

If the reference page is "\*", contact your authorized Brother dealer or the nearest Brother authorized service center.

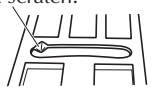
Symptom, Cause/solution	Reference
<b>The machine does not work.</b>	
The machine is not plugged in.	6
The main power switch is turned off.	6
The bobbin winder shaft is pushed to the right.	8
The foot controller is not used properly.	6
<b>The needle breaks.</b>	
The needle is not fitted properly.	13
The needle clamp screw is loose.	13
The needle is turned, bent or the point is dull.	13
The needle or thread is improper for the fabric.	12
The presser foot is not appropriate for the selected stitch.	14
The upper thread tension is too tight.	17
The fabric is pulled, pushed, or fed at an angle. ▶ Lightly guide the fabric.	16
The area around the opening in the needle plate is scratched. This is not a scratch.	*
	
The area around the opening in the presser foot is scratched.	*
The bobbin case is scratched.	*
A bobbin designed for this machine is not used.	7
<b>The upper thread breaks.</b>	
Upper threading is incorrect. (For example, the spool is not fitted properly, or the thread comes out of the thread channel.)	9
There are knots or tangles in the thread. ▶ Remove any knots or tangles.	-

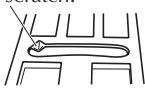
Symptom, Cause/solution	Reference
The needle is not appropriate for the thread you are using.	12
The upper thread tension is too tight.	17
The thread is tangled, for example, in the bobbin case.	27
The needle is turned, bent or the point is dull.	13
The needle is not installed properly.	13
The area around the opening in the needle plate is scratched. This is not a scratch.	*
	
The area around the opening in the presser foot is scratched.	*
The bobbin case is scratched, or has a burr on it.	*
A bobbin designed for this machine is not used.	7
<b>The bobbin thread is tangled or breaks.</b>	
The bobbin thread is wound improperly.	7
The bobbin is scratched or does not turn smoothly.	7
The thread is tangled.	25
A bobbin designed for this machine is not used.	7
The bobbin is installed incorrectly.	9
<b>The thread tension is incorrect.</b>	
Upper threading is incorrect.	9
The bobbin thread is wound improperly.	7
The needle or thread is improper for the fabric.	12
The presser foot is not attached properly.	15
The presser foot holder is not attached properly.	15
The thread tension is incorrect.	17
A bobbin designed for this machine is not used.	7
The bobbin is installed incorrectly.	9
<b>The fabric is wrinkled.</b>	
Upper threading or the bobbin installation is incorrect.	7, 9
The spool is not fitted properly.	7
The needle or thread is improper for the fabric.	12
The needle is turned, bent or the point is dull.	13
If you are sewing thin fabric, the stitch is too thick. ► Sew with stabilizer material under the fabric.	-
The thread tension is incorrect.	17
<b>Stitches are skipped.</b>	
Upper threading is incorrect.	9
The needle or thread is improper for the fabric.	12

Symptom, Cause/solution	Reference
The needle is turned, bent or the point is dull.	13
The needle is not installed properly.	13
Dust has accumulated under the needle plate or in the bobbin case.	24
<b>The thread is tangled on the wrong side of the fabric.</b>	
Upper threading is incorrect.	9
The needle or thread is improper for the fabric.	12
<b>There is a high-pitched noise while sewing.</b>	
Dust has built up in the feed dogs or in the bobbin case.	24
Upper threading is incorrect.	9
The bobbin case is scratched.	*
A bobbin designed for this machine is not used.	7
<b>The needle threader cannot be used. ★</b>	
The needle is not in the highest position.	10
The needle is installed incorrectly.	13
The needle is turned, bent or the point is dull.	13
Upper threading is incorrect.	9
The needle threader hook is bent and does not pass through the eye of the needle.	*
The needle threader lever cannot be moved or returned to its original position.	*
A size 65/9 needle is being used. ► The needle is incompatible with the needle threader. Manually pass the thread through the eye of the needle.	10
<b>The stitch is not sewn correctly.</b>	
The presser foot is not appropriate for the selected stitch.	14
The thread tension is incorrect.	17
The thread is tangled, for example, in the bobbin case.	27
<b>The fabric does not feed.</b>	
The feed dogs are lowered. ★ ► Slide the feed dog position switch to  .	21
The stitch is too fine.	15
The needle or thread is improper for the fabric.	12
The thread is tangled, for example, in the bobbin case.	27
<b>While winding the bobbin, the bobbin thread was wound below the bobbin winder seat. ★</b>	
The thread was incorrectly passed under the pretension disk on the thread guide. ► Remove any entangled thread, and then wind the bobbin.	8, 28
<b>The bobbin thread cannot be pulled up.</b>	
The needle is turned, bent or the point is dull.	13
The bobbin is installed incorrectly.	9

Symptom, Cause/solution	Reference
<b>The sewing light bulb does not come on.</b>	
The sewing light is damaged.	*
<b>The fabric feeds in the opposite direction.</b>	
The feed mechanism is damaged.	*
<b>The needle contacts the needle plate.</b>	
The needle clamp screw is loose.	13
The needle is turned, bent or the point is dull.	13
<b>Fabric being sewn with the machine cannot be removed.</b>	
Thread is tangled below the needle plate.	27
<b>A broken needle has fallen into the machine.</b>	
► Turn off the machine, and remove the needle plate. If the needle that fell into the machine can be seen, use tweezers to remove it. After removing the needle, return the needle plate to its original position and insert a new needle. Before turning on the machine, slowly turn the handwheel toward you to check that it turns smoothly and that the new needle enters through the center of the needle plate opening. If the handwheel does not turn smoothly or the needle that fell into the machine cannot be removed, consult your authorized Brother dealer or the nearest Brother authorized service center.	24
<b>The handwheel does not turn smoothly.</b>	
Thread is tangled in the bobbin case.	27
<b>Decorative stitch patterns are misaligned. ★</b>	
A wrong presser foot is used.	14
Stitch adjustment is set incorrectly.	23

## Error Messages

No.	Cause	Solution
E1	The foot controller was pressed (or Ⓜ (“Start/Stop” button) was pressed if the foot controller is not connected ★) or Ⓜ (Reverse/Reinforcement stitch button) was pressed while the presser foot is raised.	Lower the presser foot lever before continuing the operation.
E2	A stitch other than the buttonhole or bar tack stitch was selected and the foot controller was pressed (or Ⓜ (“Start/Stop” button) was pressed if the foot controller is not connected ★) while the buttonhole lever is lowered.	Raise the buttonhole lever before continuing the operation.
E3	The buttonhole or bar tack stitch was selected and the foot controller was pressed (or Ⓜ (“Start/Stop” button) was pressed if the foot controller is not connected ★) while the buttonhole lever is raised.	Lower the buttonhole lever before continuing the operation.

No.	Cause	Solution
E4	Ⓜ (Reverse/Reinforcement stitch button) (or Ⓜ (Needle position button) ★) was pressed while the bobbin winder shaft is moved to the right.	Move the bobbin winder shaft to the left before continuing the operation.
E5	Ⓜ (“Start/Stop” button) was pressed while the foot controller is connected. ★	Disconnect the foot controller or use the foot controller. ★
E6	The motor locked up because the thread is tangled.	Remove the tangled thread before continuing the operation.
E7	The stitch only for the single needle was selected and the foot controller was pressed (or Ⓜ (“Start/Stop” button) was pressed if the foot controller is not connected ★) while the twin needle mode is active.	Select a stitch for the twin needle.
F1 F9	The machine may be malfunctioning.	Contact your nearest Brother authorized service center.

## Operation beep ★

- When the machine is turned on or a key is pressed (correct operation)
  - **One beep**
- When the machine is turned on while a setting is changed (page 6)
  - **Two beeps**
- If an incorrect operation is performed or a non-functioning key is pressed
  - **Two or four beeps**
- If the machine locks up, for example, because the thread is tangled
  - **Beeps for four seconds and the machine automatically stops.**  
Be sure to check for the cause of the error, and correct it before continuing to sew.

★: Only for some models.

# Index

<b>A</b>		
accessories .....	5	
automatic reverse/reinforcement stitching .....	7, 17	
<b>B</b>		
bobbin .....	7	
bobbin case .....	24	
bobbin cover .....	4, 8	
bobbin installation .....	7	
bobbin winder .....	4, 28	
bobbin winding .....	7	
buttonhole lever .....	4	
<b>E</b>		
error messages .....	30	
extra spool pin .....	5, 14	
eyelet punch .....	5, 20	
<b>F</b>		
fabric/thread/needle combination .....	12	
feed dog position switch .....	4, 21	
feed dogs .....	4, 27, 29	
flat bed attachment .....	4	
foot controller .....	6	
free arm .....	19	
<b>H</b>		
handwheel .....	4	
<b>L</b>		
LCD .....	6	
<b>M</b>		
main parts .....	4	
main power .....	4, 6	
<b>N</b>		
needle .....	13	
needle bar thread guide .....	4, 14	
needle clamp screw .....	4	
needle plate .....	4	
needle plate cover .....	27	
needle position button .....	4	
needle stop position .....	6	
needle threader .....	4, 10	
<b>O</b>		
operation beep .....	7, 30	
operation buttons .....	4	
operation panel .....	6	
<b>P</b>		
presser foot .....	4, 14	
presser foot holder .....	4, 15	
presser foot lever .....	4, 8, 14, 16	
pretension disk .....	8, 28	
<b>Q</b>		
quick-set bobbin .....	4, 9	
quilting foot .....	5, 15	
<b>R</b>		
race .....	24	
reinforcement stitch .....	16	
reverse/reinforcement stitch button .....	4	
reverse stitch .....	16	
<b>S</b>		
seam ripper .....	5, 20	
settings .....	6	
sewing speed controller .....	4	
spool pin .....	4, 7, 10	
“Start/Stop” button .....	4	
stitch adjustment .....	7, 23	
stitch length keys .....	6, 15	
stitch selection keys .....	6, 15	
stitch width .....	15	
stitch width keys .....	6, 15	
straight stitch .....	7	
<b>T</b>		
thread cutter .....	4, 10, 16	
thread take-up lever .....	4, 10	
thread tension .....	17, 26	
thread tension dial .....	4, 26	
troubleshooting .....	25	
twin needle .....	5, 13	
<b>U</b>		
upper threading .....	9	
<b>W</b>		
walking foot .....	5, 15	

Please visit us at <http://s.brother/cpkag/> where you can get the support information (Sewing Guide, Stitch Chart, Instruction Videos, FAQs, etc.) for your Brother product.



To get information about Videos, please go to <http://s.brother/cvkag/>.



Brother SupportCenter is a mobile app that provides the support information (Instruction Videos, FAQs, etc.) for your Brother product. Visit the Google Play™ or App Store to download.



Google Play™



App Store

### Trademarks

App Store is a service mark of Apple Inc.

Android and Google Play are trademarks of Google, Inc.

Use of these trademarks are subject to Google Permissions.

English  
888-N00/N02/N20/N22/N40/N42



D01F5E-101①