

Operation Manual

Embroidery and Sewing Machine

Product Code: 882-W70



Be sure to read this document before using the machine.
We recommend that you keep this document nearby for future reference.

INTRODUCTION

Thank you for purchasing this machine. Before using this machine, carefully read the "IMPORTANT SAFETY INSTRUCTIONS", and then study this manual for the correct operation of the various functions.

In addition, after you have finished reading this manual, store it where it can quickly be accessed for future reference.

Failure to follow these instructions may result in an increased risk of personal injury or damage to property, including through fire, electrical shock, burns or suffocation.

IMPORTANT SAFETY INSTRUCTIONS

Please read these safety instructions before attempting to use the machine.

DANGER

- To reduce the risk of electric shock

- 1** Always unplug the machine from the electrical outlet immediately after using, cleaning, when making any user servicing adjustments mentioned in this manual, or if you are leaving the machine unattended.

WARNING

- To reduce the risk of burns, fire, electric shock, or injury to persons.

- 2** Always unplug the machine from the electrical outlet when removing covers, or when making any adjustments mentioned in the instruction manual.
 - To unplug the machine, switch the machine to the symbol "O" position to turn it off, then grasp the plug and pull it out of the electrical outlet. Do not pull on the cord.
 - Plug the machine directly into the electrical outlet. Do not use an extension cord.
 - Always unplug your machine if the power is cut.

3 Electrical Hazards:

- This machine should be connected to an AC power source within the range indicated on the rating label. Do not connect it to a DC power source or inverter. If you are not sure what kind of power source you have, contact a qualified electrician.
- This machine is approved for use in the country of purchase only.

- 4** Never operate this machine if it has a damaged cord or plug, if it is not working properly, if it has been dropped or damaged, or water is spilled on the unit. Return the machine to the nearest authorized Brother dealer for examination, repair, electrical or mechanical adjustment.

- While the machine is stored or in use if you notice anything unusual, such as an odor, heat, discoloration or deformation, stop using the machine immediately and unplug the power cord.
- When transporting the machine, be sure to carry it by its handle. Lifting the machine by any other part may damage the machine or result in the machine falling, which could cause injuries.
- When lifting the machine, be careful not to make any sudden or careless movements, otherwise you may injure your back or knees.

5 Always keep your work area clear:

- Never operate the machine with any air openings blocked. Keep ventilation openings of the machine and the foot controller free from the build up of lint, dust, and loose cloth.
- Do not store objects on the foot controller.
- Never drop or insert any object into any opening.
- Do not operate where aerosol (spray) products are being used or where oxygen is being administered.
- Do not use the machine near a heat source, such as a stove or iron; otherwise, the machine, power cord or garment being sewn may ignite, resulting in fire or an electric shock.
- Do not place this machine on an unstable surface, such as an unsteady or slanted table, otherwise the machine may fall, resulting in injuries.

6 Special care is required when sewing:

- Always pay close attention to the needle. Do not use bent or damaged needles.
- Keep fingers away from all moving parts. Special care is required around the machine needle.
- Switch the machine to the symbol "O" position to turn it off when making any adjustments in the needle area.
- Do not use a damaged or incorrect needle plate, as it could cause the needle to break.
- Do not push or pull the fabric when sewing, and follow careful instruction when free motion stitching so that you do not deflect the needle and cause it to break.

7 This machine is not a toy:

- Your close attention is necessary when the machine is used by or near children.
- The plastic bag that this machine was supplied in should be kept out of the reach of children or disposed of. Never allow children to play with the bag due to the danger of suffocation.
- Do not use outdoors.

8 For a longer service life:

- When using and storing this machine, avoid direct sunlight and high humidity locations. Do not use or store the machine near a space heater, iron, halogen lamp, or other hot objects.
- Use only neutral soaps or detergents to clean the case. Benzene, thinner, and scouring powders can damage the case and machine, and should never be used.
- Always consult the Operation Manual when replacing or installing any assemblies, the presser feet, needle, or other parts to assure correct installation.

9 For repair or adjustment:

- If the light unit is damaged, it must be replaced by an authorized Brother dealer.
- In the event a malfunction occurs or adjustment is required, first follow the troubleshooting table in the back of the Operation Manual to inspect and adjust the machine yourself. If the problem persists, please consult your local authorized Brother dealer.

Use this machine only for its intended use as described in the manual.

Use accessories recommended by the manufacturer as contained in this manual.

Use only the mouse designed specifically for this machine.

The contents of this manual and specifications of this product are subject to change without notice.

For additional product information and updates, visit our website at www.brother.com

SAVE THESE INSTRUCTIONS

This machine is intended for household use.

FOR USERS IN COUNTRIES EXCEPT CENELEC COUNTRIES

This appliance is not intended for use by persons (including children) with reduced physical, sensory or mental capabilities, or lack of experience and knowledge, unless they have been given supervision or instruction concerning use of the appliance by a person responsible for their safety. Children should be supervised to ensure that they do not play with the appliance.

FOR USERS IN CENELEC COUNTRIES

This appliance can be used by children aged from 8 years and above and persons with reduced physical, sensory or mental capabilities or lack of experience and knowledge if they have been given supervision or instruction concerning use of the appliance in a safe way and understand the hazards involved. Children shall not play with the appliance. Cleaning and user maintenance shall not be made by children without supervision.

FOR USERS IN THE UK, EIRE, MALTA AND CYPRUS ONLY

IMPORTANT

- In the event of replacing the plug fuse, use a fuse approved by ASTA to BS 1362, i.e. carrying the  mark, rating as marked on plug.
- Always replace the fuse cover. Never use plugs with the fuse cover omitted.
- If the available electrical outlet is not suitable for the plug supplied with this equipment, you should contact your authorized Brother dealer to obtain the correct lead.

Federal Communications Commission (FCC) Supplier's Declaration of Conformity (For U.S.A. Only)

Responsible Party: Brother International Corporation
200 Crossing Boulevard
P.O. Box 6911
Bridgewater, NJ 08807-0911
USA
TEL : (908) 704-1700

declares that the product

Product Name: Brother Sewing Machine
Model Number: XJ1

This device complies with Part 15 of the FCC Rules. Operation is subject to the following two conditions: (1) this device may not cause harmful interference, and (2) this device must accept any interference received, including interference that may cause undesired operation.

This equipment has been tested and found to comply with the limits for a Class B digital device, pursuant to Part 15 of the FCC Rules. These limits are designed to provide reasonable protection against harmful interference in a residential installation. This equipment generates, uses, and can radiate radio frequency energy and, if not installed and used in accordance with the instructions, may cause harmful interference to radio communications. However, there is no guarantee that interference will not occur in a particular installation. If this equipment does cause harmful interference to radio or television reception, which can be determined by turning the equipment off and on, the user is

encouraged to try to correct the interference by one or more of the following measures:

- Reorient or relocate the receiving antenna.
- Increase the separation between the equipment and receiver.
- Connect the equipment into an outlet on a circuit different from that to which the receiver is connected.
- Consult the authorized Brother dealer or an experienced radio/TV technician for help.
- This transmitter must not be co-located or operated in conjunction with any other antenna or transmitter.

Important

Changes or modifications not expressly approved by Brother Industries, Ltd. could void the user's authority to operate the equipment.

This equipment complies with FCC/IC radiation exposure limits set forth for an uncontrolled environment and meets the FCC radio frequency (RF) Exposure Guidelines and RSS-102 of the IC radio frequency (RF) Exposure rules. This equipment has very low levels of RF energy that it deemed to comply without maximum permissive exposure evaluation (MPE).

For Users in Canada

This device complies with Industry Canada's licence-exempt RSSs. Operation is subject to the following two conditions:

- (1) This device may not cause interference; and
- (2) This device must accept any interference, including interference that may cause undesired operation of the device.

This equipment complies with FCC/IC radiation exposure limits set forth for an uncontrolled environment and meets the FCC radio frequency (RF) Exposure Guidelines and RSS-102 of the IC radio frequency (RF) Exposure rules. This equipment has very low levels of RF energy that it deemed to comply without maximum permissive exposure evaluation (MPE).

For Users in Mexico

The operation of this equipment is subject to the following two conditions:

- (1) it is possible that this equipment or device may not cause harmful interference, and
- (2) this equipment or device must accept any interference, including interference that may cause undesired operation.

Declaration of Conformity (Europe and Turkey only)

We, Brother Industries, Ltd. 15-1 Naeshiro-cho, Mizuho-ku, Nagoya 467-8561 Japan declare that this product is in conformity with the essential requirements of all relevant directives and regulations applied within the European Community.

The Declaration of Conformity (DoC) can be downloaded from Brother Solutions Center.

Visit <http://s.brother/cpeaa/> and:

- click "Manuals"
- select your model
- click "Declaration of Conformity"
- click "Download"

Your Declaration will be downloaded as a PDF file.

Declaration of Conformity for RE Directive 2014/53/ EU (CENELEC and Turkey only) (Applicable to models with radio interfaces)

We, Brother Industries, Ltd. 15-1 Naeshiro-cho, Mizuho-ku, Nagoya 467-8561 Japan declare that these products are in conformity with the provisions of the RE Directive 2014/53/EU. A copy of the Declaration of Conformity can be downloaded by following the instructions in the Declaration of Conformity (Europe and Turkey only) section.

Wireless LAN (Models with Wireless LAN function only)

This machine supports wireless interface.

Frequency band(s): 2400-2483.5 MHz

Maximum radio-frequency power transmitted in the frequency band(s): Less than 20 dBm(e.i.r.p)

For Users in Norway

This subsection does not apply for the geographical area within a radius of 20 km from the centre of Ny-Alesund on Svalbard.

Dette underavsnittet gjelder ikke for det geografiske området innenfor en radius av 20 km fra sentrum av Ny-Ålesund på Svalbard.

For Users in Thailand

This telecommunication equipment conforms to NTC technical requirement.

Laser Notices (For U.S.A. only)

Laser Safety

This sewing machine is certified as a Class 1 laser product under the U.S. Department of Health and Human Services (DHHS) Radiation Performance Standard according to the Radiation Control for Health and Safety Act of 1968. This means that the sewing machine does not produce hazardous laser radiation.

IEC 60825-1 Specification

This machine is a Class 1 laser product as defined in IEC 60825-1:2007 and IEC 60825-1:2014 specifications.

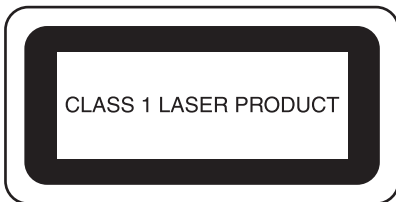

The laser beam emitted by the laser unit installed in this machine is restricted to an output at a safe level. However, the machine contains 6-milliwatt, 630-640nanometer wavelength, 6-12 degree at parallel divergence angle, 28-40 degree at perpendicular divergence angle, InGaAlP laser diodes. Therefore, eye damage may result from disassembling or altering this machine.

Safety precautions have been designed to prevent any possible laser beam exposure to the operator.

FDA Regulations

U.S. Food and Drug Administration (FDA) has implemented regulations for laser products manufactured on and after August 2, 1976. Compliance is mandatory for products marketed in the United States. The label shown on the back of the sewing machine indicates compliance with the FDA regulations and must be attached to laser products marketed in the United States.

Brother Industries, Ltd.
15-1, Naeshiro-cho, Mizuho-ku, Nagoya 467-8561,
JAPAN

This product complies with FDA performance standards for laser products except for deviations pursuant to Laser Notice No. 50, dated June 24, 2007.

CAUTION

- Use of controls, adjustments or the performance of procedures other than those specified in this manual may result in hazardous radiation exposure.

Laser Notices (For countries except U.S.A.)

IEC 60825-1 Specification

This machine is a Class 1 laser product as defined in IEC 60825-1:2007 and IEC 60825-1:2014 specifications.

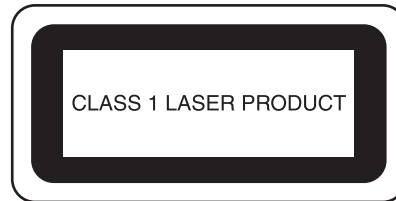

The laser beam emitted by the laser unit installed in this machine is restricted to an output at a safe level. However, the machine contains 6-milliwatt, 630-640nanometer wavelength, 6-12 degree at parallel divergence angle, 28-40 degree at perpendicular divergence angle, InGaAlP laser diodes. Therefore, eye damage may result from disassembling or altering this machine.

Safety precautions have been designed to prevent any possible laser beam exposure to the operator.

CAUTION

- This sewing machine has a Class 3B Laser Diode in the Laser Unit. The Laser Unit should not be opened under any circumstances.
- Use of controls, adjustments or the performance of procedures other than those specified in this manual may result in hazardous radiation exposure.

Terms of Use

IMPORTANT-PLEASE READ CAREFULLY:

This Terms of Use ("Agreement") is a legal agreement between Brother Industries, Ltd. ("Company") and you that governs your use of any Software, installed on or made available by Company for use with sewing or craft products ("Company Product"). The term of "Software" means any and all contents data, design data, data format, firmware of Company Product, and PC application or mobile device application.

By using the Software and Company Product, you shall be deemed to have agreed to be bound by the terms of this Agreement. If you do not agree to the terms of this Agreement, Company is unwilling to license the Software and you are not allowed to use the Software. Amendments and supplements to this Agreement may be attached to the Software.

An individual who accepts this Agreement on behalf of an entity represents to Company that he or she has the legal right to enter into a binding legal agreement for that entity.

Terms and Conditions

1 Grant of License.

- 1.1 Subject to this Agreement, Company hereby grants you a personal, non-exclusive, non-transferable and revocable license to use the Software only within the Company Product.
- 1.2 Your right to use of the Software is licensed and not sold, and solely for your use subject to this Agreement. Company or its suppliers retains all right, title, and interest relating to Software, including without limitation all intellectual property rights relating thereto.

2 Restrictions

- 2.1 Except as expressly set out in this Agreement or as required by any local law, you shall undertake:
 - 2.1.1 not to disassemble, de-compile, reverse engineer, translate or otherwise attempt to learn the source code of the Software (including the data or contents created by using the Company Product or contents editing application software; hereinafter the same shall apply in this Clause 2.);
 - 2.1.2 not to create derivative works based on the whole or any part of the Software;
 - 2.1.3 not to distribute, provide or make available the Software in any form, in whole or in part to any person without prior written consent from Company;
 - 2.1.4 not to copy the Software, except where such copying is incidental to normal use of the Software with Company Product or where it is necessary for the purpose of back-up or operational security;
 - 2.1.5 not to transfer, rent, lease, sub-license, loan, translate, merge, adapt, vary, alter or modify, the whole or any part of the Software nor permit the Software or any

part of it to be combined with, or become incorporated in, any other programs;

- 2.1.6 to include Company's copyright notice and this Agreement on all entire and partial copies of the Software; and
- 2.1.7 not to use the Software for any purpose (including, but not limited to, use with unauthorized sewing/craft products or software) other than as provided under Clause 1 of this Agreement.

3 No warranty

TO THE EXTENT PERMISSIBLE BY APPLICABLE LAW, THIS SOFTWARE IS PROVIDED TO YOU "AS IS" WITHOUT WARRANTIES OR CONDITIONS OF ANY KIND, WHETHER ORAL OR WRITTEN, EXPRESS OR IMPLIED. COMPANY SPECIFICALLY DISCLAIMS ANY IMPLIED WARRANTIES OR CONDITIONS OF MERCHANTABILITY, SATISFACTORY QUALITY, NON-INFRINGEMENT AND/OR FITNESS FOR A PARTICULAR PURPOSE.

4 Limitation of liability

- 4.1 COMPANY SHALL NOT BE LIABLE TO YOU, ITS END-USERS OR ANY OTHER ENTITY FOR ANY LOSS OF PROFITS OR INCOME OR SAVINGS, LOSS OF DATA, INTERRUPTION OF USE, OR CONSEQUENTIAL, INCIDENTAL, SPECIAL, PUNITIVE OR INDIRECT DAMAGES INCURRED BY SUCH PARTY (WHETHER IN AN ACTION IN CONTRACT OR TORT), EVEN IF COMPANY HAS BEEN ADVISED OF THE POSSIBILITY OF SUCH DAMAGES, ARISING OUT OF OR RELATING TO THE SOFTWARE, SUPPORT SERVICE OR THIS AGREEMENT. THESE LIMITATIONS SHALL APPLY TO THE MAXIMUM EXTENT ALLOWED BY APPLICABLE LAW NOTWITHSTANDING ANY FAILURE OF ESSENTIAL PURPOSE OF ANY LIMITED REMEDY.
- 4.2 NOTWITHSTANDING THE CLAUSE 3 OR 4.1 HEREOF, THIS AGREEMENT DOES NOT PURPORT TO EXCLUDE OR RESTRICT COMPANY'S LIABILITY FOR DEATH OR PERSONAL INJURY RESULTING FROM NEGLIGENCE OR LIMIT THE STATUTORY RIGHTS OF A CONSUMER.

5 Termination

- 5.1 Company shall have the right to terminate this Agreement at any time by providing a written notice to you if you commit a material breach of any terms of this Agreement and fail to immediately rectify such breach upon Company's request.
- 5.2 Upon termination for any reason all rights granted to you under this Agreement shall cease, you shall cease all activities authorized by this Agreement and you shall immediately delete or remove the Software from all computer equipment in your possession and delete or destroy all copies of the Software or its derivative works in your possession. In addition to the above, you shall delete contents

or design data created by you from the Company Product in your possession.

6 Miscellaneous terms

- 6.1 You shall not export or re-export the Software or any copy or adaptation thereof in violation of any applicable laws or regulations.
- 6.2 You shall not assign all or any part of this Agreement to any third party or any interest therein, without prior written consent of Company. A change of control or reorganization of you pursuant to a merger, sale of assets or stock shall be deemed to be an assignment under this Agreement.
- 6.3 You agree that a breach of this Agreement will cause irreparable injury to Company for which monetary damages would not be an adequate remedy and Company shall be entitled to seek equitable relief in addition to any remedies it may have hereunder or at law without a bond, other security, or proof of damages.
- 6.4 If any provisions of this Agreement shall be declared or determined as void or unenforceable by a court of competent jurisdiction, such provisions shall be severable and independent from the other provisions of this Agreement and the validity of the other provisions and of the entire Agreement shall not be affected thereby.
- 6.5 This Agreement, together with all exhibits or other attachments referenced herein, constitutes the entire agreement between the parties on the subject matter hereof, and supersedes all proposals, oral and written, between the parties on this subject.
- 6.6 If Company fails to insist that you perform any of your obligations under this Agreement, or if Company does not enforce any rights against you, or if Company delay in doing so, that will not mean that Company have waived any rights against you and will not mean that you do not have to comply with those obligations. If Company does waive a default by you, Company will only do so in writing, and that will not mean that Company will automatically waive any later default by you.
- 6.7 The laws of the state or country where you live (or, if a business, where your principal place of business is located) govern all claims and disputes concerning the Software or this Agreement.

TRADEMARKS

Secure Digital (SD) Card is a registered trademark or a trademark of SD-3C, LLC.
CompactFlash is a registered trademark or a trademark of Sandisk Corporation.
Memory Stick is a registered trademark or a trademark of Sony Corporation.
SmartMedia is a registered trademark or a trademark of Toshiba Corporation.
MultiMediaCard (MMC) is a registered trademark or a trademark of Infineon Technologies AG.
xD-Picture Card is a registered trademark or a trademark of Fuji Photo Film Co. Ltd.
This software is based in part on the work of the Independent JPEG Group.
WPA™ and WPA2™ are trademarks of Wi-Fi Alliance®.

Each company whose software title is mentioned in this manual has a Software License Agreement specific to its proprietary programs.

Any trade names and product names of companies appearing on Brother products, related documents and any other materials are all trademarks or registered trademarks of those respective companies.

OPEN SOURCE LICENSING REMARKS

This product includes open-source software.
To see the open source licensing remarks, please go to the manual download section on your model's home page of Brother Solutions Center at "<http://s.brother/cpeaa/>".

CONTENTS

Chapter 1 Getting Ready	11	Chapter 3 Various Stitches	71
NAMES OF MACHINE PARTS	12	UTILITY STITCHES	72
Included Accessories.....	15	Straight Stitches.....	72
Accessories that are Included in Some Countries or regions.....	18	Zigzag Stitches.....	76
Options.....	18	Overcasting.....	76
Using the Multi-Purpose Screwdriver (Included with Some Models).....	20	Quilting.....	77
Using the Spool Stand (Included with Some Models).....	20	Blind Hem Stitches.....	83
TURNING THE MACHINE ON/OFF	22	Shell Tuck Stitches.....	85
LCD SCREEN	23	Scallop Stitches.....	85
Using the Machine Settings Key.....	27	Smocking Stitches.....	85
Using the Machine Help.....	31	Fagoting.....	86
Using the Stitch Pattern Explanation Function.....	32	Attaching Tape or Elastic.....	86
WIRELESS NETWORK CONNECTION FUNCTIONS	33	Heirloom.....	87
Enabling a Wireless Network Connection.....	33	One-Step Buttonholes.....	88
Setting Up the Wireless Network Connection.....	33	Four-Step Buttonholes.....	90
CONNECTING THE ACCESSORY TO THE MACHINE	35	Bar Tacks.....	92
Using a USB Mouse (Sold Separately).....	35	Button Sewing.....	93
WINDING/INSTALLING THE BOBBIN	36	Eyelet.....	94
Winding the Bobbin.....	36	Multi-Directional Sewing (Straight Stitch and Zigzag Stitch).....	94
Setting the Bobbin.....	40	Zipper Insertion.....	95
Pulling Up the Bobbin Thread.....	41	MAKING ADJUSTMENTS	97
UPPER THREADING	42	MAKING STEP STITCH PATTERNS (FOR 7MM SATIN STITCH PATTERNS ONLY)	98
Upper Threading.....	42	USING THE MEMORY FUNCTION	99
Using the Twin Needle Mode.....	45	Saving Stitch Patterns.....	99
Using the Spool Stand.....	46	Retrieving Stitch Patterns.....	99
CHANGING THE NEEDLE	48	MY CUSTOM STITCH	100
FABRIC/THREAD/NEEDLE COMBINATIONS	49	Retrieving Saved Stitch Patterns.....	103
CHANGING THE PRESSER FOOT	50		
Replacing the Presser Foot.....	50	Chapter 4 Basic Embroidery	105
Attaching the Presser Foot with the Included Adapter.....	50	BEFORE EMBROIDERING	106
Using the Dual Feed Foot.....	51	Embroidery Step by Step.....	106
Chapter 2 Sewing Basics	55	Attaching Embroidery Foot “W+” with LED Pointer.....	106
SEWING	56	About the Embroidery Unit.....	107
Stitch Types.....	56	SELECTING PATTERNS	108
Basic Sewing.....	56	Selecting Embroidery Patterns.....	109
Combining Stitch Patterns.....	58	Selecting Character Patterns.....	110
Sewing Reverse Stitches/Reinforcement Stitches.....	59	Selecting Frame Patterns.....	112
Automatic Reverse/Reinforcement Stitching.....	60	Combining Patterns.....	112
Automatic Presser Foot Lowering Function and Thread Cutting Function.....	61	EDITING PATTERNS	114
STITCH SETTINGS	62	Previewing the Pattern.....	116
Setting the Stitch Width/Stitch Length/“L/R Shift”.....	62	Changing the Size and the Density of the Pattern.....	117
Setting the Thread Tension.....	62	Creating Repeated Patterns.....	117
Saving Your Stitch Settings.....	63	Embroidering the Pattern Repeatedly.....	120
USEFUL FUNCTIONS	64	EDITING COLORS	122
Automatic Thread Cutting.....	64	Changing the Thread Color.....	122
Adjusting the Needle Drop Point with the Guideline Marker.....	64	Finding New Color Schemes with the Color Shuffling Function.....	123
Pivoting.....	65	Thread Color Sorting.....	124
Using the Knee Lifter.....	66	VIEWING THE EMBROIDERY SCREEN	125
Automatic Fabric Sensor System (Automatic Presser Foot Pressure).....	67	PREPARING THE FABRIC	127
Needle Position - Stitch Placement.....	67	Attaching Iron-on Stabilizers (Backing) to the Fabric.....	127
Using the Straight Stitch Needle Plate and the Straight Stitch Foot.....	67	Hooping the Fabric in the Embroidery Frame.....	128
USEFUL SEWING TIPS	69	ATTACHING THE EMBROIDERY FRAME	130
Sewing Tips.....	69	CONFIRMING THE PATTERN POSITION	131
Sewing Various Fabrics.....	69	Checking the Needle Drop Point with the Embroidery Foot “W+” with LED Pointer.....	131
Sewing Decorative Stitch Patterns.....	70	Displaying a Background Image.....	132
		Checking the Pattern Position.....	133
		EMBROIDERING A PATTERN	134
		Embroidering Attractive Finishes.....	134
		Embroidering Patterns.....	135
		Using Appliqués.....	136
		ADJUSTMENTS DURING THE EMBROIDERY PROCESS	138

If the Thread Breaks or the Bobbin Runs out of Thread During Embroidering	138	STITCH SETTING CHART	194
Resuming Embroidery after Turning off the Power.....	138	INDEX.....	200
Chapter 5 Advanced Embroidery	139		
VARIOUS EMBROIDERING FUNCTIONS	140		
Basting Embroidery	140		
Creating an Appliqué Piece.....	140		
MAKING EMBROIDERY ADJUSTMENTS	143		
Adjusting Thread Tension	143		
Adjusting the Alternate Bobbin Case (with No Color on the Screw).....	145		
Using the Automatic Thread Cutting Function (End Color Trim).....	146		
Using the Thread Trimming Function (Jump Stitch Trim)	146		
Adjusting the Embroidery Speed	147		
Changing the Thread Color Display	147		
Aligning the Pattern and the Needle.....	147		
Embroidering Linked Characters	148		
USING THE MEMORY FUNCTION.....	150		
Saving Embroidery Patterns.....	150		
Retrieving Embroidery Patterns	150		
EMBROIDERY APPLICATIONS	151		
Using a Frame Pattern To Make an Appliqué	151		
Embroidering Split Embroidery Patterns	152		
Chapter 6 My Design Center	155		
ABOUT MY DESIGN CENTER.....	156		
PATTERN DRAWING SCREEN	156		
Before Creating Designs	158		
Drawing Lines.....	158		
Drawing Regions	159		
Using the Stamp Key	160		
Using the Erase Key	161		
Using the Select Key	161		
STITCH SETTINGS SCREEN.....	162		
Specifying Individual Stitch Settings	162		
Specifying Global Stitch Settings	163		
Loading the Background Image.....	164		
LINE CONVERSION.....	165		
Create a Pattern with Line Conversion	165		
ILLUSTRATION CONVERSION.....	167		
Create a Pattern with Illustration Conversion.....	167		
STIPPLING	169		
Basic Stippling with My Design Center	169		
Decorative Stitching around a Pattern in Embroidery (a Quilting Function).....	171		
Chapter 7 Appendix	175		
CARE AND MAINTENANCE.....	176		
Restrictions on Oiling	176		
Precautions on Storing the Machine.....	176		
Cleaning the Race	176		
Cleaning the Cutter in the Bobbin Case Area	177		
ADJUSTING THE SCREEN.....	177		
Touch Panel is Malfunctioning.....	177		
TROUBLESHOOTING.....	178		
Frequent Troubleshooting Topics	178		
Upper Thread is Too Tight	178		
Tangled Thread on Wrong Side of Fabric	179		
Incorrect Thread Tension	179		
Fabric is Caught in the Machine and Cannot Be Removed	180		
Untangling Thread from beneath the Bobbin Winder Seat.....	182		
List of Symptoms.....	182		
ERROR MESSAGES	187		
SPECIFICATIONS	192		
UPGRADING YOUR MACHINE'S SOFTWARE	194		

1

2

3

4

5

6

7



Chapter **1** Getting Ready

Be sure to install the latest software.

Refer to "UPGRADING YOUR MACHINE'S SOFTWARE" on page 194.

<http://s.brother/cpeaa/>

NAMES OF MACHINE PARTS

■ Main Parts

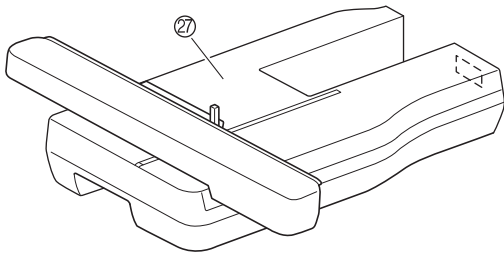
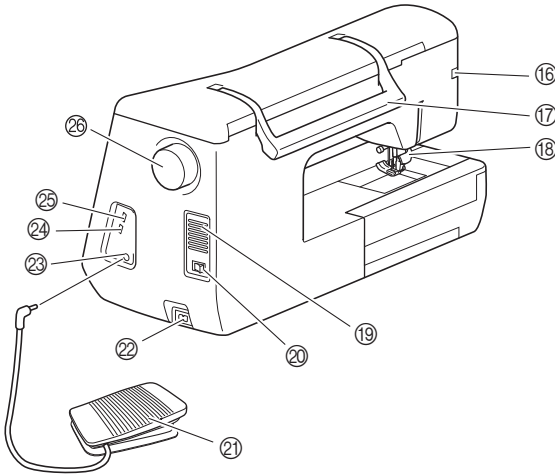
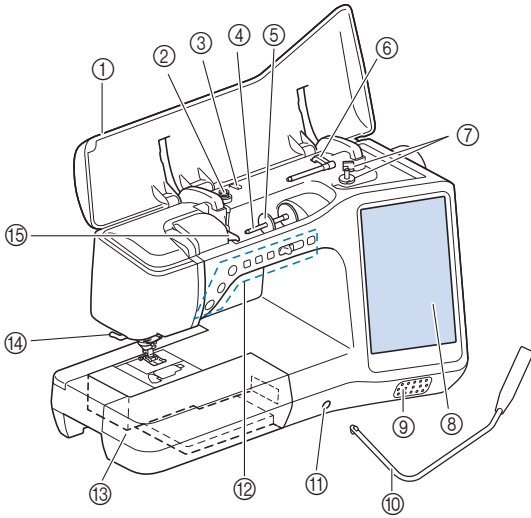

- ① Top cover
- ② Pretension disk (page 37)
- ③ Thread guide for bobbin winding (page 37)
- ④ Spool pin (page 42)
- ⑤ Spool cap (page 36)
- ⑥ Supplemental spool pin (page 36)
- ⑦ Bobbin winder (page 36)
- ⑧ LCD (liquid crystal display) (page 23)
- ⑨ Speaker
- ⑩ Knee lifter (page 66)
- ⑪ Knee lifter slot (page 66)
- ⑫ Operation buttons and sewing speed controller (page 13)

- ⑬ Flat bed attachment with accessory compartment (page 14)
- ⑭ Thread cutter (page 43)
- ⑮ Thread guide plate (page 39)
- ⑯ Connector for the presser foot (page 52, page 107)
- ⑰ Handle
Carry the machine by its handle when transporting the machine.
- ⑱ Presser foot lever
You cannot use the presser foot lever after the presser foot has been raised using  (Presser foot lifter button).
- ⑲ Air vent
The air vent allows the air surrounding the motor to circulate. Do not cover the air vent while the machine is being used.
- ⑳ Main power switch (page 22)
- ㉑ Foot controller (page 58)
- ㉒ Power cord receptacle (page 22)
- ㉓ Foot controller jack (page 58)
- ㉔ USB port for mouse (page 35)
- ㉕ USB port
- ㉖ Handwheel
Turn the handwheel toward you (counterclockwise) to raise and lower the needle.
- ㉗ Embroidery unit (page 107)

■ Needle and Presser Foot Section

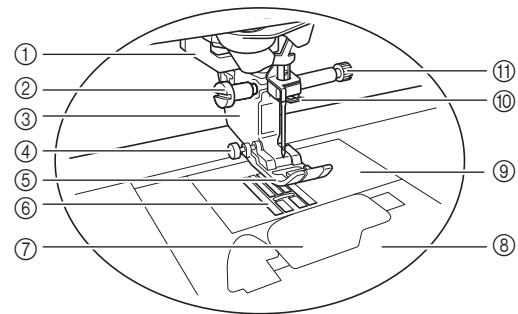

- ① Buttonhole lever (page 89)
- ② Presser foot holder screw (page 50, page 106)
- ③ Presser foot holder (page 50)
- ④ Presser foot locking pin (page 69)
- ⑤ Presser foot
The presser foot consistently applies pressure to the fabric as sewing takes place. Attach the appropriate presser foot for the selected stitch.
- ⑥ Feed dogs
The feed dogs feed the fabric in the sewing direction.
- ⑦ Bobbin cover (page 40)
- ⑧ Needle plate cover (page 40)
- ⑨ Needle plate (page 72)
- ⑩ Needle bar thread guide (page 43)
- ⑪ Needle clamp screw (page 48)

Measurements on the needle plate, bobbin cover (with mark) and needle plate cover

The measurements on the bobbin cover are references for stitch patterns with a middle (center) needle position. The measurements on the needle plate and the needle plate cover are references for stitches with a left needle position.

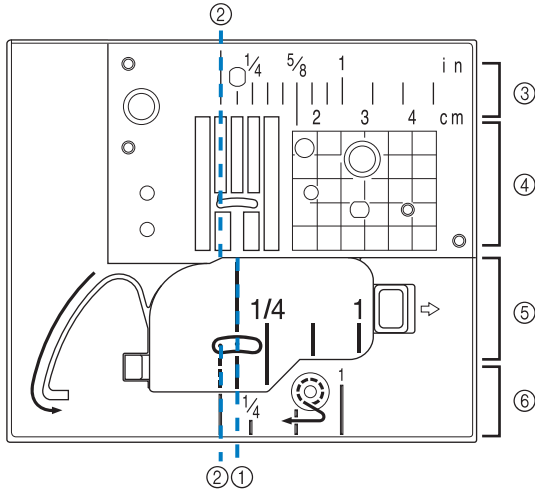

- ① For stitches with a middle (center) needle position
- ② For stitches with a left needle position
- ③ Left needle position on the needle plate <inch>
- ④ Left needle position on the needle plate <cm>
- ⑤ Middle (center) needle position on the bobbin cover (with mark) <inch>
- ⑥ Left needle position on the needle plate cover <inch>

■ Operation Buttons

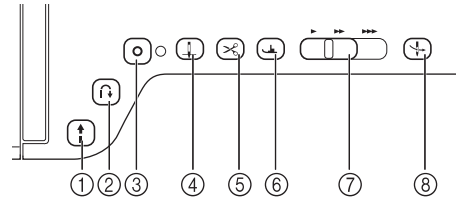



- ① **“Start/Stop” button** 

Press the “Start/Stop” button to start or stop the machine. The button changes color according to the machine’s operation mode.

Green: The machine is ready or is operating.
Red: The machine is not ready.
- ② **Reverse stitch button** 

Press the reverse button to sew reverse or reinforcement stitches depending on the selected stitch pattern. (page 59)
- ③ **Reinforcement stitch button** 

Press the reinforcement button to sew a single stitch repeatedly and tie-off. (page 59)
For character/decorative stitches, press this button to end with a full stitch instead of at a mid-point.
The LED beside the button automatically lights up while the stitch is being sewn and goes off when sewing is finished.
- ④ **Needle position button** 

Press the needle position button to raise or lower the needle position. Pressing the button twice sews a single stitch.
- ⑤ **Thread cutter button** 

Press the thread cutter button after sewing to automatically trim the excess thread.
- ⑥ **Presser foot lifter button** 

Press the presser foot lifter button to lower the presser foot and apply pressure to the fabric. Press this button again to raise the presser foot.
- ⑦ **Sewing Speed controller** 

Use the sewing speed controller to adjust the sewing speed. Move the slide to the left to sew at slower speeds. Move the slide to the right to sew at higher speeds.
- ⑧ **Automatic threading button** 

Use the automatic threading button to automatically thread the needle.

Using the Flat Bed Attachment

Pull the top of the flat bed attachment to open the accessory compartment.

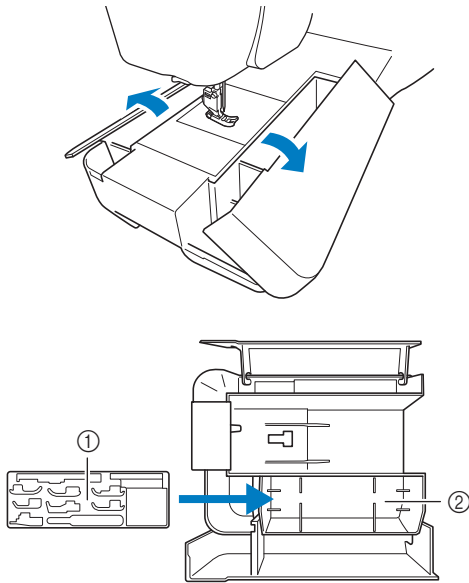

- ① Presser foot storage tray
- ② Presser foot storage space of the flat bed attachment

Using the Accessory Case (Included with Some Models)

- Opening the accessory case

Fully slide the bar on each side of the accessory case to the unlocked position, and then lift off the lid to open the case.

The case can only be opened or locked correctly if both bars are slid in the same direction.

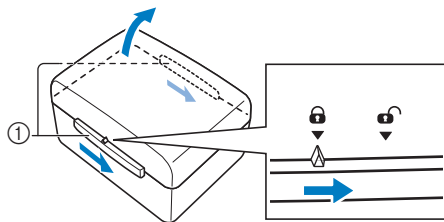

- ① Bars

- Closing the accessory case

- 1** Fully slide the bar on each side of the accessory case lid to the unlocked position.

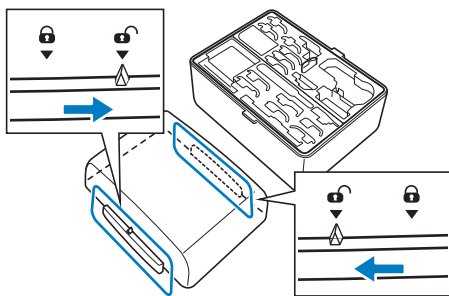

- 2** Place the lid on top of the case so that the notches in the lid align with the tabs on the case, and then slide the bar on each side back to the locked position.

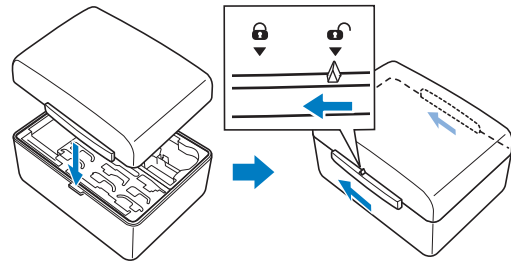

Storing Bobbin Clips

Bobbin clips can be stored inside of the accessory case cover.

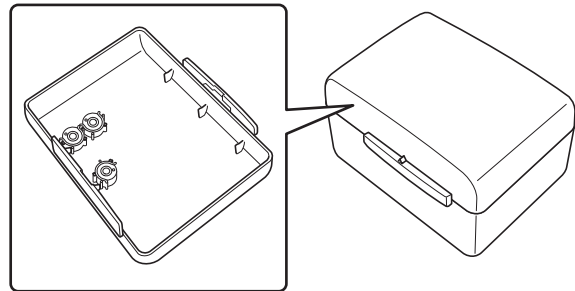



Memo

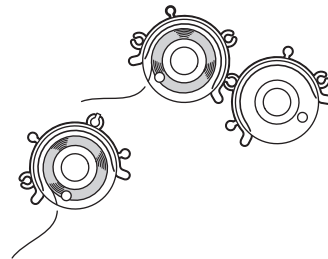



- Placing bobbin clips on bobbins helps prevent the thread from unwinding from the bobbin. In addition, snapping bobbin clips together allows the bobbins to be conveniently stored and prevents them from rolling around if they are dropped.

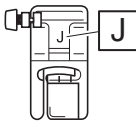
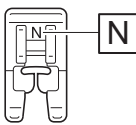
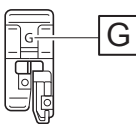
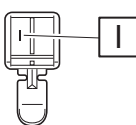
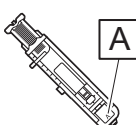
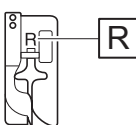
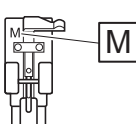
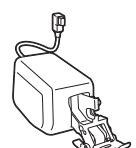



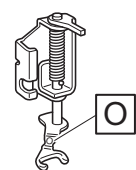
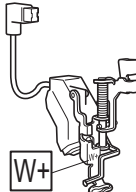
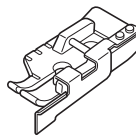
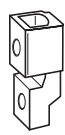

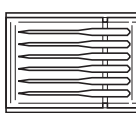
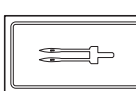
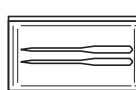



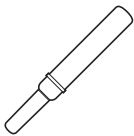



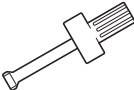





Included Accessories



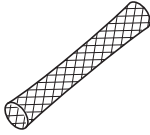

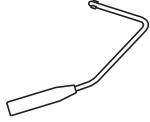
After opening the box, check that the following accessories are included. If any item is missing or damaged, contact your authorized Brother dealer.



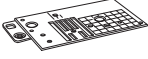

	Part Name
	Part Code
	Zigzag foot "J" (on machine)
	XF3022-001
	Monogramming foot "N"
	X53840-351
	Overcasting foot "G"
	XC3098-051
	Zipper foot "I"
	X59370-051
	Buttonhole foot "A"
	X57789-351
	Blind stitch foot "R"
	X56409-051
	Button fitting foot "M"
	130489-001
	Dual feed foot
	SA196 (U.S.A.) / SA196C (Canada) DF1: XF4166-001 (Europe) DF1CN: 115C05E601C (China) DF1AP: XF6843-001 (other areas)
	Straight stitch foot
	SA167 (Americas) F042N: XG6615-001 (Europe) F042: XC1973-052 (other areas)

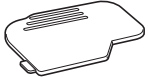
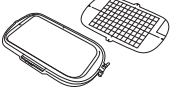
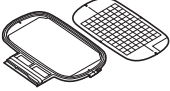
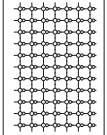
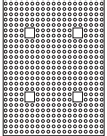
	Part Name
	Part Code
	Free motion open toe quilting foot "O"
	XF4873-001
	Embroidery foot "W+" with LED pointer
	SA197 (U.S.A.) / SA197C (Canada) FLED1: XF4168-001 (Europe) FLED1AP: 115C05E700W (other areas)
	1/4 quilting foot with guide
	SA185 (Americas) F057: XC7416-252 / 115C05E0005 (Europe) F057: 115C05E7005 (other areas)
	Adapter
	SA131 (Americas) F010N: XG2001-001 / 115Z05E0004 (Europe) F010AP: 115Z05E7004 (other areas)
	Screw (small)
	XA4813-051
	Needle set 75/11 2 needles 90/14 2 needles 90/14 2 needles: Ball point needle (gold colored)
	XE4962-001
	Twin needle 2.0/11 needle
	XE4963-001
	Ball point needle set 75/11 2 needles: Ball point needle for embroidery
	XD0705-151
	Bobbin x 10 (One bobbin is in machine.)
	SA156 (Americas) SFB: XA5539-151 / 115J05E0001 (Europe) SFB: 115J05E7001 (other areas)

	Part Name
	Part Code
	Seam ripper
	XF4967-001
	Scissors
	XF2052-001
	Cleaning brush
	X59476-051
	Eyelet punch
	XZ5051-001
	Screwdriver (small)
	X55468-051
	Screwdriver (large)
	XC4237-021
	Disc-shaped screwdriver
	XC1074-051
	Spool cap (small)
	130013-154
	Spool cap (medium) × 2 (One spool cap is on machine.)
	X55260-153
	Spool cap (large)
	130012-054

	Part Name
	Part Code
	Thread spool insert (mini king thread spool)
	XA5752-121
	Bobbin clip × 10
	XE3060-001
	Spool felt (on machine)
	X57045-051
	Spool net × 2
	XA5523-050
	Embroidery needle plate cover
	XE5131-001
	Touch pen (stylus)
	XA9940-051
	Knee lifter
	XA6941-052
	Foot controller
	XD0501-151 (Europe) XC8816-051 (other areas)
	Standard bobbin case (green marking on the screw) (on machine)
	XE5342-101
	Alternate bobbin case (no color on the screw)
	XC8167-651

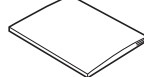
	Part Name
	Part Code
	Straight stitch needle plate
	XF3076-001
	Cord guide bobbin cover (with single hole)
	XE8991-101
	Bobbin cover (with mark)
	XF0750-101
	Bobbin cover (on machine)
	XE8992-101
	Embroidery frame with decal set H 36 cm x W 24 cm (H 14 inches x W 9-1/2 inches)
	SA449S (Americas) EF95S: XH4465-001 / 115D05E0017 (Europe) EF95SAP: 115D05E7017 (other areas)
	Embroidery frame with decal set H 18 cm x W 13 cm (H 7 inches x W 5 inches)
	SA439S (Americas) EF75S: XH4464-001 / 115D05E0016 (Europe) EF75SAP: 115D05E7016 (other areas)
	Embroidery positioning sticker sheets x 4
	SAEPS2 (U.S.A.) / SAEPS2C (Canada) EPS2: XG6749-001 / 115Z05E000E (Europe) EPS2CN: 115Z05E600E (China) EPS2: XF0763-001 (other areas)
	Lens calibration sheet
	XH4336-001
	Embroidery bobbin thread (#60, white)
	SA-EBT (Americas) EBT-CEN: X81164-001 / 115G05E0001 (Europe) EBT-CEN: 115G05E7001 (other areas)
	Stabilizer material
	SA519 (Americas) BM3: XG6683-001 / 115Z05E0007 (Europe) BM3CN: 115Z05E6007 (China) BM3: XE0806-001 (other areas)





	Part Name
	Part Code
	Grid sheet set
	SA507 (Americas) GS3: 115Z05E000N (Europe) GS3: 115Z05E700N (other areas)
	Chalk pencil
	XE8568-001
	Operation Manual
	This manual
	Quick Reference Guide
	XH3872-001 (Americas) XH3949-001 (Europe) XH3874-001 (other areas)

 **Memo**

- (For U.S.A. only)
Foot controller: Model T
This foot controller can be used on the machine with product code 882-W70. The product code is mentioned on the machine rating plate.
- The presser foot holder screw is available through your authorized Brother dealer (Part code XA5904-051).
- Please visit “ <http://s.brother/cpeaa/> ” to download documents.

Accessories that are Included in Some Countries or regions

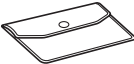
If these accessories are not included with your machine, these are available as optional accessories.

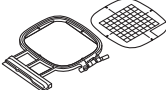
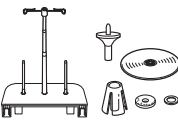
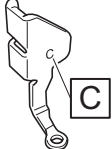
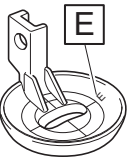



	Part Name
	Part Code
	Bobbin center pin and instruction sheet
	XF5048-001
	Multi-purpose screwdriver
	SAMDRIVER1 (U.S.A.) / SAMDRIVER1C (Canada) MDRIVER1: XG1298-001 / 115Z05E0003 (Europe) MDRIVER1AP: 115Z05E7003 (other areas)
	Accessory case
	XH4063-001
	Accessory bag
	XC4487-021
	Embroidery frame with decal set H 24 cm x W 24 cm (H 9-1/2 inches x W 9-1/2 inches)
	SA450S (Americas) EF97S: XH4466-001 / 115D05E0018 (Europe) EF97SAP: 115D05E7018 (other areas)
	Embroidery frame with decal set H 10 cm x W 10 cm (H 4 inches x W 4 inches)
	SA438S (Americas) EF74S: XH4463-001/ 115D05E0015 (Europe) EF74SAP: 115D05E7015 (other areas)
	Spool stand
	SA562 (U.S.A.) / SA562C (Canada) TS6: XF4180-001 (Europe) TS6: 115L05E7002 (other areas)
	Free motion quilting foot "C"
	XF4737-001
	Free motion echo quilting foot "E"
	XE0766-001



	Part Name
	Part Code
	Vertical spool pin
	XC8619-052

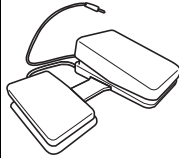

Options

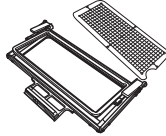
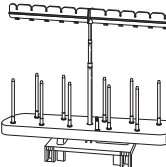
The following are available as optional accessories to be purchased separately from your authorized Brother dealer.

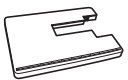
* These embroidery frames can be used for general embroidery but cannot be used with the application (My Design Snap).

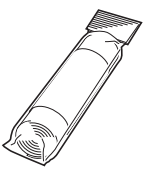
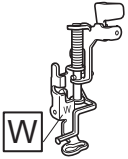
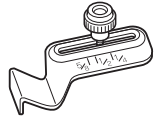
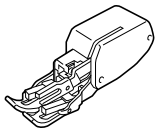
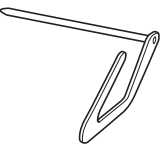
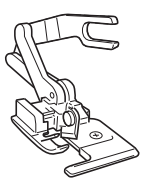
	Part Name
	Part Code
	Multi-function foot controller
	SAMFFC (U.S.A.) / SAMFFCC (Canada) MFFC1: XG6777-001 (Europe) MFFC1CN: 115F05E6002 (China) MFFC1OC: 115F05E7002 (other areas)
	* Embroidery frame set H 30 cm x W 20 cm (H 12 inches x W 8 inches)
	SA447 (Americas) EF92: XG6717-001 (Europe) EF92: 115D05E700Z (other areas)
	* Embroidery frame set H 20 cm x W 20 cm (H 8 inches x W 8 inches)
	SA446 (U.S.A.) / SA446C (Canada) EF91: XG6715-001 (Europe) EF91: XE5068-101 (other areas)
	* Embroidery frame set H 15 cm x W 15 cm (H 6 inches x W 6 inches)
	SA448 (U.S.A.) / SA448C (Canada) SEF150: XG6761-001 (Europe) SFE150: 115D05E700E (other areas)
	* Border embroidery frame H 30 cm x W 10 cm (H 12 inches x W 4 inches)
	SABF6200D1 (U.S.A.) / SABF6200D1C (Canada) BF3: XG6763-001 (Europe) BF3: XF4170-001/115D05E700N (other areas)
	10 spool stand
	SA561 (U.S.A.) / SA561C (Canada) TS5: XG6765-001 (Europe) TS5: 115L05E7003 (other areas)

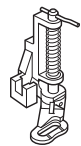
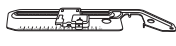
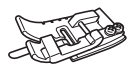
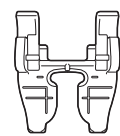
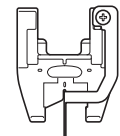
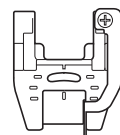
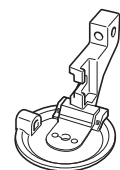
	Part Name
	Part Code
	Wide table
	SAWT6200D (U.S.A.) / SAWT6200DC (Canada) WT10: XG6767-001 (Europe) WT10: XF4184-001 (other areas)
	Embroidery bobbin thread (#60, black)
	SAEBT999 (Americas) EBT-CEBN: XG6643-001 (Europe) EBT-CEBN: XC5520-001 (other areas)
	Stabilizer material
	SA519 (Americas) BM3: XG6683-001 / 115Z05E0007 (Europe) BM3CN: 115Z05E6007 (China) BM3: XE0806-001 (other areas)
	Water soluble stabilizer
	SA520 (Americas) BM5: XG6681-001 (Europe) BM5CN: 115Z05E600J (China) BM5: XE0615-001 (other areas)
	Embroidery foot "W"
	XF4012-001
	Seam guide
	SA538 (Americas) SG1: XC8483-052 (Europe) SG1: 115Z05E7002 (other areas)
	Walking foot
	SA140 (Americas) F033N: XG6623-001 (Europe) F033CN: 115C05E6015 (China) F033N: 115C05E7015 (other areas)
	Quilting guide
	SA132 (Americas) F016N: XC2215-052 (Europe) F016CN: 115Z05E6009 (China) F016N: 115Z05E7001 (other areas)
	Side cutter foot
	SA177 (Americas) F054: XC3879-152 (Europe) F054CN: 115C05E6008 (China) F054: 115C05E7008 (other areas)

	Part Name
	Part Code
	Free-motion quilting foot
	SA129 (Americas) F005N: XC1948-052 (Europe) F005N: 115C05E7002 (other areas)
	Circular attachment
	SACIRC1 (U.S.A.) / SACIRC1C (Canada) CCIRC1: XG6705-001 (Europe) CIRC1CN: 115Y05E6003 (China) CIRC1: 115Y05E7003 (other areas)
	Stitch in the ditch foot
	SA191 (Americas) F065: XF2339-001 (Europe) F065CN: 115C05E600C (China) F065: 115C05E700C (other areas)
	Open toe for dual feed foot
	SA195 (Americas) XG6773-001 (Europe) F070CN: 115C05E6011 (China) F070: 115C05E7011 (other areas)
	Stitch in the ditch dual feed foot
	SA204 (U.S.A.) / SA204C (Canada) F075: XG3155-001 (Europe) F075AP: 115C05E700Y (other areas)
	1/4 inch guide dual feed foot
	SA205 (U.S.A.) / SA205C (Canada) F076: XG4868-001 (Europe) F076AP: 115C05E701D (other areas)
	Couching foot
	SA199V (U.S.A.) / SA199VC (Canada) F073: XF8185-001 (Europe) F073AP: XF8188-001 (other areas)
	Narrow Zipper Foot "I+"
	SA208 (U.S.A.) / SA208C (Canada) F079: 115C05E002D (Europe) F079CN: 115C05E602D (China) F079AP: 115C05E702D (other areas)
	Concealed Zipper Foot "K"
	SA102 (U.S.A.) / SA102C (Canada) F080: 115C05E002E (Europe) F080AP: 115C05E702E (other areas)
	USB mouse
	XE5334-101

Memo

- To obtain optional accessories or parts, contact your authorized Brother dealer or visit our site “ <http://s.brother/cpeaa/> ”.
- All specifications are correct at the time of printing. Please be aware that some specifications may change without notice.
- A variety of feet are available to enable different types of stitching and finishes. Visit your nearest authorized Brother dealer or our site “ <http://s.brother/cpeaa/> ” for a complete listing of optional accessories available for your machine.
- Always use accessories recommended for this machine.

Using the Multi-Purpose Screwdriver (Included with Some Models)

Since the screwdriver can be changed to three different positions, it can be extremely useful for the various machine preparations.

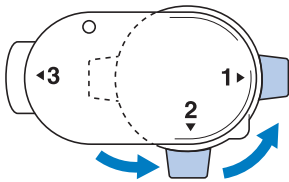

Position “1”	You can install/remove the presser foot holder, needle clamp screw.
Position “2”	You can install/remove the needle plate.
Position “3”	The multi-purpose screwdriver can be positioned over the screw on the embroidery frame to tighten the screw after hooping the fabric or when removing the fabric.

Using the Spool Stand (Included with Some Models)

The included spool stand is useful when using thread spools with a large diameter (cross-wound thread). The spool stand can hold two spools of thread.

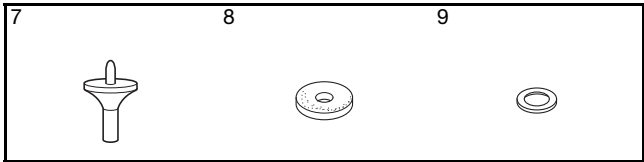
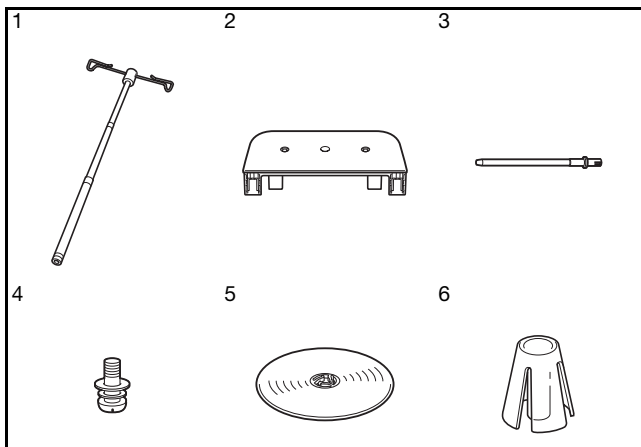

No.	Part Name	Part Code
1	Telescopic thread guide	XE0776-001
2	Spool support	XE4637-001
3	Spool pin × 2	XA6313-051
4	Screw and washer	XC7568-051
5	Spool cap (XL) × 2	XE0779-001
6	Spool holder × 2	XA0679-050
7	Spool cap base × 2	XE0780-001
8	Spool felt × 2	XC7134-051
9	Ring × 4	026030-136

CAUTION

- Do not lift the handle of the machine while the spool stand is installed.
- Do not push or pull the telescopic thread guide or spool pins with extreme force, otherwise damage may result.
- Do not place any object other than spools of thread on the spool support.
- Do not try to wind thread on the bobbin while sewing using the spool stand.

How to Assemble the Spool Stand

- 1 Fully extend the telescopic thread guide shaft, and then rotate the shaft until the two internal stoppers click into place.

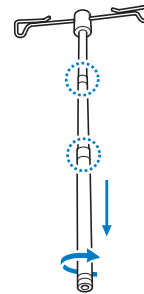

- 2** Insert the telescopic thread guide into the round hole at the center of the spool support, and then use a screwdriver to securely tighten the screw from the reverse side.

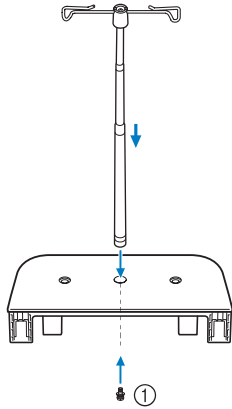

① Screw

Note

- Make sure that the stoppers on the telescopic thread guide shaft are firmly in place and that the thread guide openings are directly above the two holes for spool pins in the spool support. In addition, check that the shaft is securely tightened in the spool support.

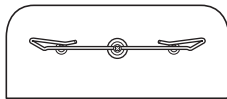

- 3** Firmly insert the two spool pins into the two holes in the spool support.

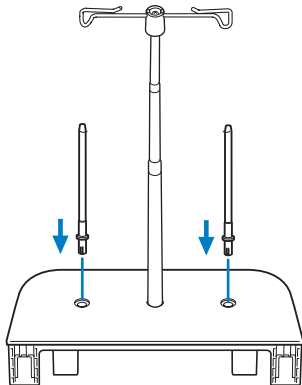

- 4** Open the upper cover of the machine, and then pull the upper cover up to remove it from the machine.

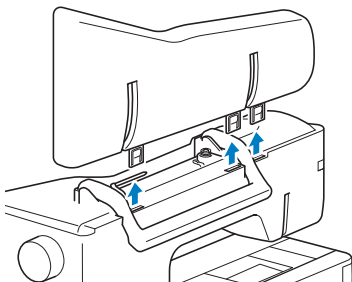

- 5** Insert the spool stand onto the notches of the machine.

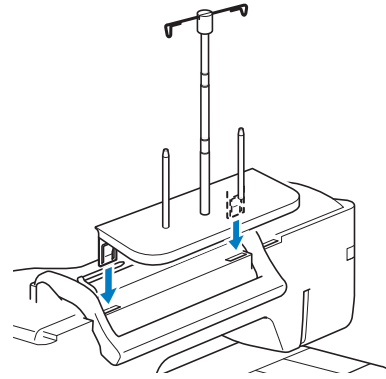

How To Remove

- 1** Pull the spool stand up to remove it from the machine.

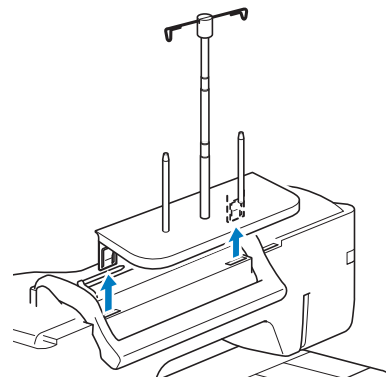

- 2** Attach the upper cover to the machine.

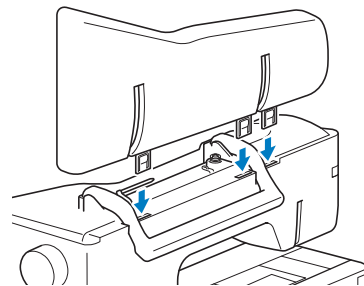

TURNING THE MACHINE ON/OFF

⚠ WARNING

- Use only regular household electricity for the power source. Using other power sources may result in fire, electric shock, or damage to the machine.
- Make sure that the plugs on the power cord are firmly inserted into the electrical outlet and the power cord receptacle on the machine. Otherwise, a fire or electric shock may result.
- Do not insert the plug on the power cord into an electrical outlet that is in poor condition.
- Turn the main power to OFF and remove the plug in the following circumstances:
 - When you are away from the machine
 - After using the machine
 - When the power fails during use
 - When the machine does not operate correctly due to a bad connection or a disconnection
 - During electrical storms

⚠ CAUTION

- Use only the power cord included with this machine.
- Do not use extension cords or multi-plug adapters with many other appliances plugged in to them. Fire or electric shock may result.
- Do not touch the plug with wet hands. Electric shock may result.
- When unplugging the machine, always turn the main power to OFF first. Always grasp the plug to remove it from the outlet. Pulling on the cord may damage the cord, or lead to fire or electric shock.
- Do not allow the power cord to be cut, damaged, modified, forcefully bent, pulled, twisted, or bundled. Do not place heavy objects on the cord. Do not subject the cord to heat. These things may damage the cord, or cause fire or electric shock. If the cord or plug is damaged, take the machine to your authorized Brother dealer for repairs before continuing use.
- Unplug the power cord if the machine is not to be used for a long period of time. Otherwise, a fire may result.

- (For U.S.A only)
This appliance has a polarized plug (one blade wider than the other). To reduce the risk of electrical shock, this plug is intended to fit in a polarized electrical outlet only one way. If the plug does not fit fully in the electrical outlet, reverse the plug. If it still does not fit, contact a qualified electrician to install the proper electrical outlet. Do not modify the plug in any way.

- 1 Insert the power supply cord into the power cord receptacle, then insert the plug into a wall outlet.

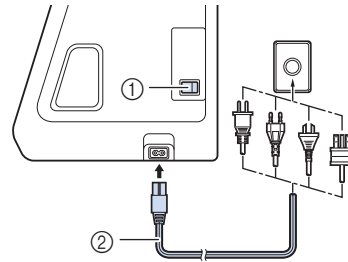

- ① Main power switch
- ② Power supply cord

- 2 Turn the main power switch to "I" to turn on the machine.

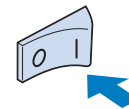

Memo

- The light, LCD and the "Start/Stop" button light up when the machine is turned on. The machine will make a sound. This is not a malfunction.

- 3 When the machine is turned on, the opening movie is played. Press anywhere on the screen.

- 4 Turn the main power switch to "O" to turn off the machine.

■ Setting Your Machine for the First Time

When you first turn on the machine, set the language and time/date to your language and local time/date.

- 1 Press and to set your local language and then press .

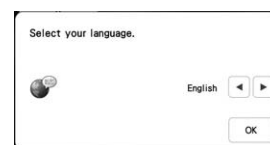

2 The message screen, confirming if you want to set time/date, appears. Press **OK**.

3 Press **-** or **+** to set time/date.

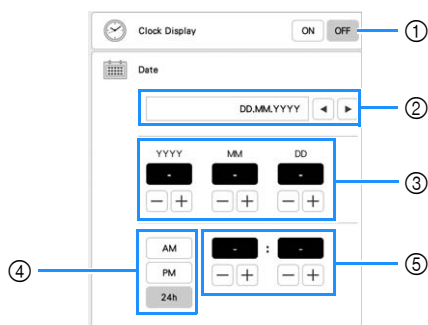

- 1 Select [ON] to display time/date on the screen.
- 2 Press **◀** or **▶** to select the date display format.
- 3 Set the year (YYYY), month (MM) and date (DD).
- 4 Select whether 24h or 12h setting will display.
- 5 Set the current time.

4 Press **OK** to set.

→ The clock starts from 0 second of the time you set.

Note

- The time/date you set may be cleared, if you don't turn on the machine for an extended period of time.

LCD SCREEN

Touch the LCD screen or a key with your finger or the included touch pen to select a machine function.

⚠ CAUTION

- Only touch the screen with your finger or the touch pen (stylus) included with the machine. Do not use a mechanical pencil, screwdriver or any other hard or sharp object. In addition, do not press the screen with extreme pressure. Otherwise the screen may be damaged.
- All or part of the screen may sometimes become darker or lighter due to changes in the surrounding temperature or other changes in the environment. This is not a sign of a malfunction. If the screen is difficult to read, adjust its brightness.

Home Page Screen

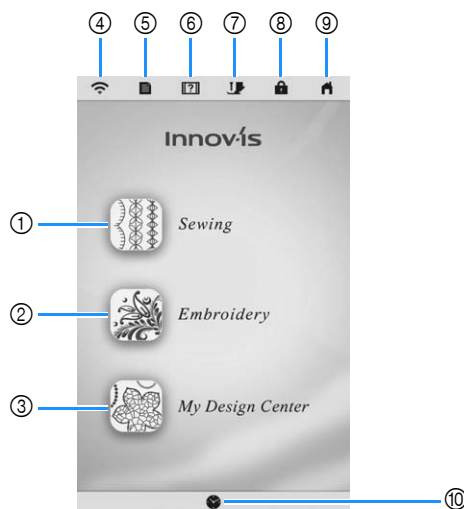

No.	Display Name	Explanation	Page
1	Sewing key	Select a utility stitch or character/decorative stitch pattern.	56
2	Embroidery key	Select an embroidery pattern. Attach the embroidery unit.	108
3	My Design Center key	Create an original embroidery pattern.	156
4	Wireless LAN key	Shows the machine's signal strength. Press this key to specify the wireless settings.	29, 33
5	Machine settings key	Change the needle stop position, adjust the pattern or screen, and change other machine settings.	27
6	Machine help key	See explanations on how to use the machine. You can see the tutorial videos and also MP4 movie files that you have saved on USB media.	31
7	Presser foot/Needle exchange key	Press this key before changing the needle, the presser foot, etc. This key locks all key and button functions to prevent operation of the machine. Press this key again to unlock the settings.	40, 48, 50
8	Screen lock key	Lock the screen. When the screen is locked, can still sew, but cannot change any of the screen functions. Press this key again to unlock the screen.	—
9	Home page screen key	Return to the home page screen at any time and select a different mode ([Sewing], [Embroidery] or [My Design Center]).	—
10	Time/Date key	Set the time/date.	22

■ Utility Stitch Screen

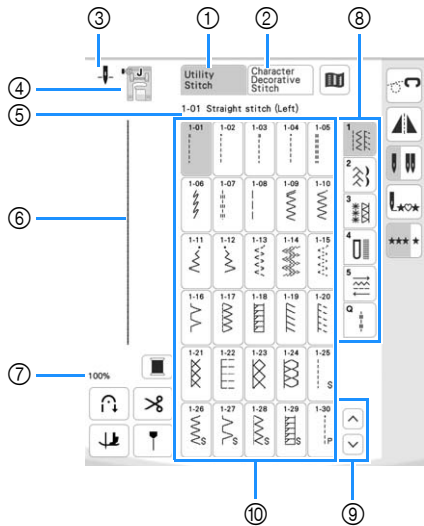

■ Character/Decorative Stitch Screen

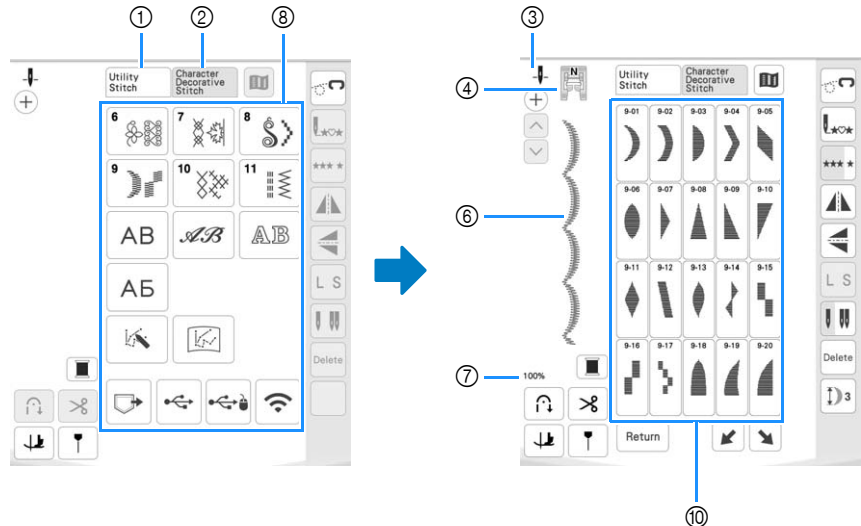

No.	Display	Name	Explanation	Page
①		Utility stitch key	Select a straight stitch, zigzag stitch, buttonhole, blind hem stitch, or other stitch (utility stitch) commonly used in garment making.	56
②		Character/Decorative stitch key	Select character or decorative stitch patterns.	56
③		Needle position setting display	Shows single or twin needle mode setting, and the needle stop position. Single needle/down position Twin needle/down position Single needle/up position Twin needle/up position	45, 65
④		Presser foot display	Shows the presser foot code. Attach the presser foot indicated in this display before sewing. * The symbols for certain presser feet, such as zipper foot “I”, may not appear in the screen.	50
⑤	1-01 Straight stitch (Left)	Selected stitch display	Shows the name and code number of the selected stitch.	-
⑥		Stitch preview	Shows a preview of the selected stitch. When shown at 100%, the stitch appears in the screen at nearly its actual size.	-
⑦	100%	Stitch pattern display size	Shows the approximate size of the stitch pattern selected. 100%: Nearly the same size as the sewn stitch pattern 50%: 1/2 the size of the sewn stitch pattern 25%: 1/4 the size of the sewn stitch pattern	-
⑧	-	Category	Select the category of the stitch pattern you want to sew.	56
⑨		Page key	Press or , to move the pages of stitch selection screen, one page at a time. You can scroll up and down the pages by touching the screen.	-
⑩		Stitch selection screen	Press the key for the stitch pattern you want to sew.	-



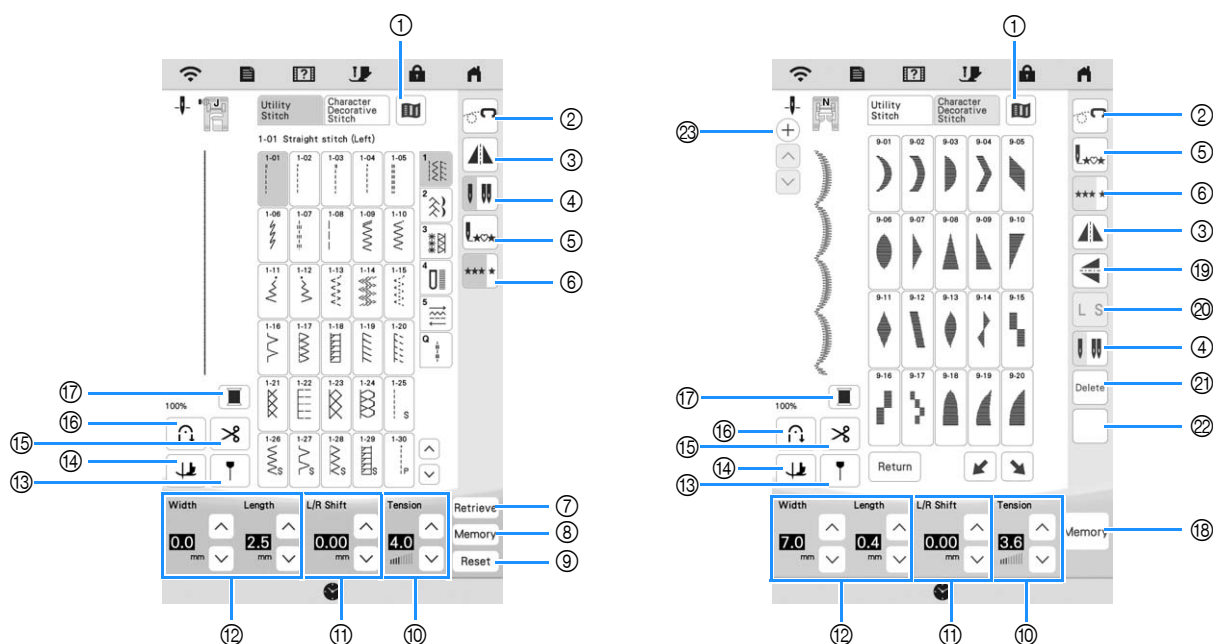



















Key Functions



Note

- Some editing functions cannot be used with certain stitch patterns. Only the functions for the displayed keys are available when a stitch pattern is selected.
- The machine default setting is highlighted.

No.	Display	Name	Explanation	Page
①		Image key	Display an enlarged image of the selected stitch pattern. Press to change the thread color in the image. To display the enlarged image, press . To view any part of the image that extends out of the viewable display area, press .	-
②		Free motion mode key	Press this key to enter free motion sewing mode. The presser foot is raised to an appropriate height and the feed dog is lowered for free motion quilting.	80
③		Horizontal mirror image key	Create a horizontal mirror image of the stitch pattern.	-
④		Needle mode selection key (single/double)	Press this key to select twin needle mode. The sewing mode changes between single needle mode and twin needle mode each time you press the key. • If the key is light gray after selecting the stitch, the selected stitch cannot be sewn in the twin needle mode.	45
⑤		Back to beginning key	When sewing is stopped, press this key to return to the beginning of the stitch.	-
⑥		Single/Repeat sewing key	Select single stitches or continuous stitches. To finish a complete motif while sewing the stitch pattern continuously, you can press this key while sewing. The machine will automatically stop when the motif is finished.	98
⑦		Retrieve key	Retrieve a saved stitch pattern.	63
⑧		Manual memory key	Change the stitch pattern settings (zigzag width and stitch length, thread tension, automatic thread cutting or automatic reinforcement stitching, etc.), then save them by pressing this key. Five sets of settings can be saved for a single stitch pattern.	63
⑨		Reset key	Return the saved settings for the selected stitch pattern to their defaults.	63
⑩		Thread tension key	Shows the automatic thread tension setting of the currently selected stitch pattern. You can use and to change the thread tension settings.	62

No.	Display	Name	Explanation	Page
⑪		“L/R Shift” key	Press  to shift the stitch pattern to the right or press  to shift the stitch pattern to the left. This feature is not available for all stitch patterns. Only those applicable will be shifted.	62
⑫		Stitch width and stitch length key	Shows the zigzag width and stitch length settings of the currently selected stitch pattern. You can use  and  to adjust the zigzag width and stitch length settings.	62
⑬		Guideline marker key	Display the guideline marker along the sewing line. The guideline marker makes it easier to align stitches with the fabric edge or other marker on the fabric.	64
⑭		Pivot key	Turn on/off the pivot function. When the pivot function is selected, stopping the machine lowers the needle and slightly raises the presser foot automatically. In addition, when sewing is restarted, the presser foot is automatically lowered.	65
⑮		Automatic thread cutting key	Turn on this function to set the machine to automatically sew reinforcement stitches (or reverse stitches, depending on the selected stitch pattern) at the beginning and end of stitching and to trim the threads at the end of stitching.	64
⑯		Automatic reverse/reinforcement stitch key	If you select this setting before sewing, the machine will automatically sew reinforcement stitches at the beginning and end of sewing (depending on the pattern, the machine may sew reverse stitches).	60
⑰		Thread color change key	Change the thread color in the image.	–
⑱		Memory key	Save stitch pattern combinations.	99
⑲		Vertical mirror image key	Create a vertical mirror image of the stitch pattern.	–
⑳		Size selection key	Select the size of the stitch pattern (large, small).	–
㉑		Delete key	Delete the selected stitch pattern.	59
㉒	Some of the following keys will appear, depending on the selected stitch pattern.			
		Elongation key	When 7mm satin stitch patterns are selected, you can choose from 5 automatic length settings, without changing the stitch zigzag width or stitch length settings. 	–
		Thread density key	When the satin stitch patterns are selected, you can change the thread density of the stitch pattern.  : Low density  : High density	–
		Character spacing key	Change the spacing of character stitch patterns. The setting is applied to all entered characters.	–
㉓		Add stitch pattern key	Combine stitch patterns.	58

Using the Machine Settings Key

Press to change the default machine settings (needle stop position, embroidery speed, opening display, etc.). To display the different settings screens, press for "Sewing settings", for "General settings", for "Embroidery settings" or for "Wireless LAN settings".

Memo

- Press or to display a different settings screen.

Sewing Settings

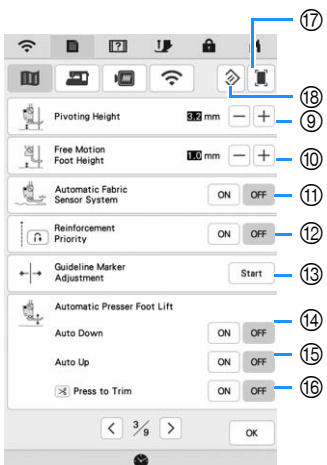
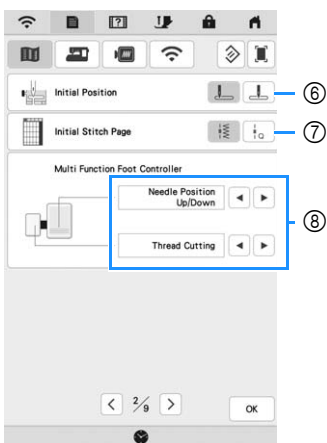
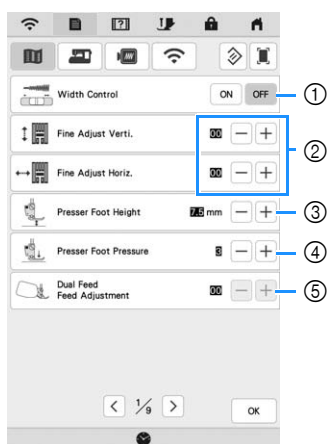

- ① Select whether to use the sewing speed controller to determine the zigzag width (page 79).
- ② Make adjustments to character or decorative stitch patterns (page 97).
- ③ Adjust the presser foot height. Select the height of the presser foot when the presser foot is raised.
- ④ Adjust the presser foot pressure. The higher the number, the greater the pressure will be. Set the pressure at [3] for normal sewing.
- ⑤ Adjust the amount of fabric feeding of the dual feed foot (page 53).
- ⑥ Select whether [1-01 Straight stitch (Left)] or [1-03 Straight stitch (Middle)] is the utility stitch that is automatically selected when the machine is turned on.
- ⑦ Select whether utility stitches or quilting stitches are displayed first on the stitch selection screen.
- ⑧ You can activate this setting after connecting the multi-function foot controller (sold separately). (These settings appear when the multi-function foot controller is connected to the machine.)

Controller	Functions that can be specified
Main foot controller	Start/Stop
Heel switch	Select any of the following: <ul style="list-style-type: none"> • [Thread Cutting] • [Needle Position Up/Down]
Side pedal	Select any of the following: <ul style="list-style-type: none"> • [Single Stitch] • [Reverse Stitch] (Reinforcement Stitch) • [Presser Foot Up/Down] • [No setting]

- ⑨ Select the height of the presser foot when sewing is stopped when the pivot setting is selected (page 65).
- ⑩ Select the height of the presser foot when the machine is set to free motion sewing mode (page 80).
- ⑪ When set to [ON], the thickness of the fabric is automatically detected by an internal sensor while sewing. (page 67)
- ⑫ When set to [ON], reinforcement stitches are sewn at the beginning and/or end of sewing for a reinforcement stitch pattern, even when (Reverse stitch button) is pressed (page 60).
- ⑬ Adjust the guideline marker position and brightness (page 65).
- ⑭ Select whether to lower the presser foot automatically before starting sewing. (page 61)
- ⑮ Select whether to raise the presser foot automatically when stopping sewing. (page 61)
- ⑯ Select whether pressing (Thread cutter button) automatically lowers the presser foot before cutting the thread. The presser foot will be raised after the thread is cut. (page 61)
- ⑰ You can save the current settings screen image in a USB media by pressing this button when the USB media is inserted into the USB port. The files are saved in a folder labeled [bPocket].
- ⑱ Reset settings on this page to original default. Some settings are not reset.

■ General Settings

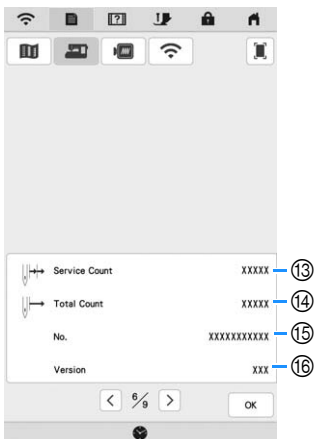
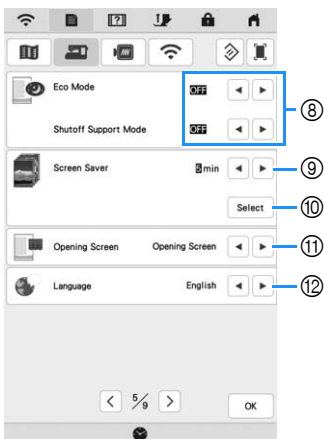
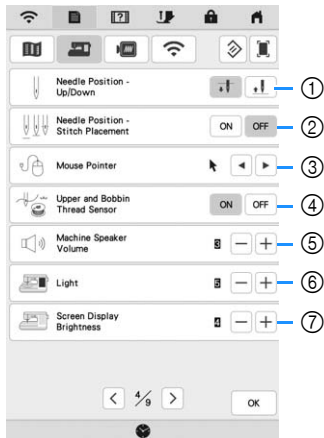

or lowered.

[OFF] : Switches the needle position between being raised or lowered.

- ③ Select the shape of the pointer when a USB mouse is used.
- ④ Turn both the upper and bobbin thread sensors [ON] or [OFF]. If it is turned [OFF], the machine can be used without thread.
- ⑤ Select the speaker volume. Increase the number for louder volume, decrease for softer volume.
- ⑥ Select the brightness of the work area lights.
- ⑦ Select the screen display brightness.
- ⑧ Set the [Eco Mode] and the [Shutoff Support Mode] to save the machine power (page 29).
- ⑨ Select the length of time until the screen saver appears.
- ⑩ Select the image of the screen saver (page 30).
- ⑪ Select the initial screen that is displayed when the machine is turned on.
- ⑫ Select the display language.
- ⑬ Shows the service count which is a reminder to take your machine in for regular servicing. (Contact your authorized Brother dealer for details.)
- ⑭ Shows the total number of stitches sewn on this machine.
- ⑮ Shows the internal machine number for this machine.
- ⑯ Shows the program version.

Memo

- Install the latest software. Check with your local authorized Brother dealer or at “ <http://s.brother/cpeaa/> ” for available updates (page 194).

CAUTION

- When [Upper and Bobbin Thread Sensor] is set to [OFF], the machine cannot detect tangled upper thread. Continuing to use the machine with tangled thread may cause damage.

① Select the needle stop position (the needle position when the machine is not operating) to be up or down. Select the down position when using the pivot key.

② Select the operation of the (Needle position button) from the following two sequences (page 67).

Each press of the (Needle position button):
 [ON] : Switches the needle position between being raised, stopped immediately before entering the fabric,

Embroidery Settings

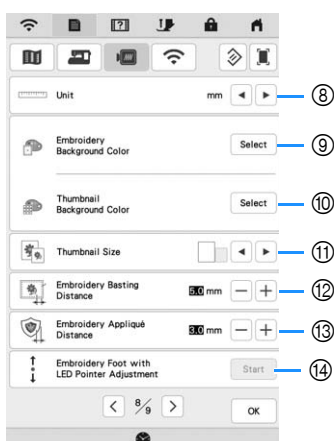
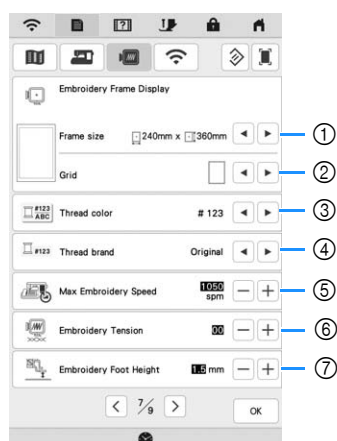

- ① Select the embroidery frame to be used.
- ② Select the center point marker or grid lines.
- ③ Select the thread color display on the embroidery screen; thread number, color name. (page 147)
- ④ Select the thread brand of the thread color display. (page 147)
- ⑤ Adjust the maximum embroidery speed (page 147).
- ⑥ Adjust the upper thread tension for embroidering (page 144).
- ⑦ Select the height of the embroidery foot during embroidering (page 127).
- ⑧ Select the display units for embroidering (mm/inch).
- ⑨ Select the color of the background for the embroidery display area.
- ⑩ Select the color of the background for the thumbnail area.
- ⑪ Select the size of pattern thumbnails.
- ⑫ Adjust the distance between the pattern and the basting stitching. (page 140)
- ⑬ Adjust the distance between the appliqué pattern and the outline (page 140).
- ⑭ Adjust the position and brightness of the embroidery foot "W+" with LED pointer (this setting is available if embroidery foot "W+" with LED pointer has been attached.) (page 131).

Wireless LAN Settings

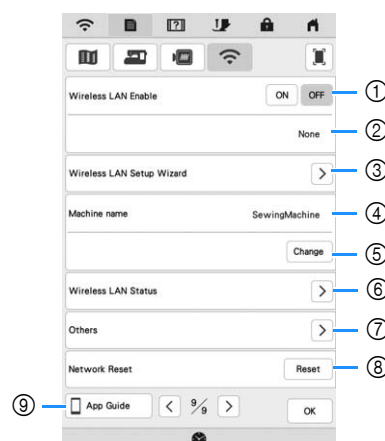

- ① Enable/Disable the wireless LAN function (page 33).
- ② Shows the connected SSID.
- ③ Set the machine to connect wireless LAN function.
- ④ Shows the machine name used on the wireless network. This name is used when transferring files from the machine to the embroidery editing software (PE-DESIGN 11).
- ⑤ Change the machine name used on the wireless network.
- ⑥ Check the wireless LAN status.
- ⑦ Display other menus.
- ⑧ Reset network operations.
- ⑨ Display the introduction to the application.

Setting the [Eco Mode] and the [Shutoff Support Mode]

You can save the machine power by setting the [Eco Mode] and the [Shutoff Support Mode].

If you leave the machine turned on without using it for the set period of time, the machine enters in each mode. Press

 to display [Eco Mode] and [Shutoff Support Mode]. (page 28)

[Eco Mode];

Machine will enter a sleep mode after the set period of time. Touch the screen or press the "Start/Stop" button to continue operating.

[Shutoff Support Mode];



Machine will enter the lower power mode after the set period of time. Turn the machine off and then back on to restart operating.

Note

- If you turn off the machine while the machine is in the [Eco Mode] or the [Shutoff Support Mode], wait for about 5 seconds before turning on the machine again.

■ Changing the Screen Saver Image

Instead of the default image, you can select your own personal images for the screen saver of your machine. Before changing the screen saver image, prepare the image on USB media. For details on compatible image files, refer to "SPECIFICATIONS" on page 192.

- 1 Press  .
→ The settings screen appears.
- 2 Press  .
→ The general settings screen appears.
- 3 Display [Screen Saver] in the general settings screen.

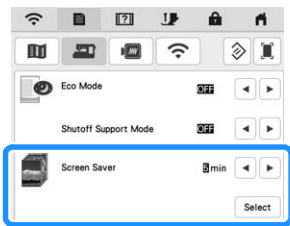

- 4 Press in [Screen Saver].

- 5 Press .

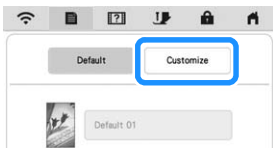

- 6 Connect the USB media that contains your personal image to the USB port of the machine.

- 7 Press to select the first image.



- 8 Select the device that is connected.



→ A list of your personal images appears on the screen.

- * : Delete the selected image.
- * : Return to the previous page.

- 9 Select a file name and then press .

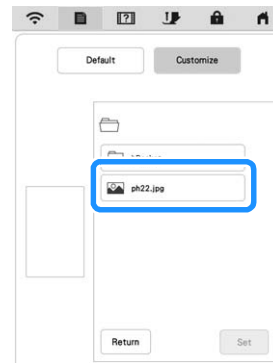

→ The selected image is stored on your machine.

- * : Return to the previous page.

- 10 Repeat steps 7 through 9 to set the remaining images.

- 11 Press to return to the original screen.

Using the Machine Help

Press to display the machine help screen. Functions are available from the screen shown below.

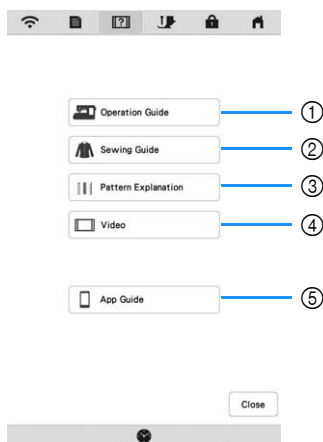

- ① Explanation for upper threading, winding the bobbin, preparing to embroider a pattern, and how to use the machine (page 31)
- ② Procedures for sewing utility stitches (page 31)
- ③ Explanation of the stitch selected
- ④ Tutorial videos or MPEG-4 (MP4) videos (page 31, page 32)
- ⑤ Introduction to the application

Using the Operation Guide Function

Press to display the screen shown below. Categories are displayed at the top of the screen. Press a key to see more information about that category. Some of the functions are described in the movies. Watch these movies for a better understanding of the functions.



- ① Information about the main parts of the machine and their functions
- ② Information about the operation buttons
- ③ Information about threading the machine, changing presser feet, etc.
- ④ Information about attaching the embroidery unit, preparing fabric for embroidering, etc.
- ⑤ Information about troubleshooting
- ⑥ Information about cleaning the machine, etc.

Using the Sewing Guide Function

Use this function when you are not sure which stitch to use for your application, or to get advice about sewing particular stitches.

- ① Enter Utility Stitch category from the home page.
- ② Press .
- ③ Press . → The advice screen is displayed.
- ④ Press the key of the category whose sewing instructions you wish to view.

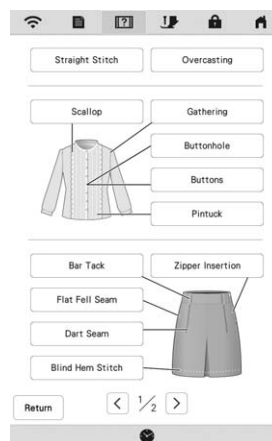

- ⑤ Read the explanations and select the appropriate stitch. → The screen displays directions for sewing the selected stitch. Follow the directions to sew the stitch.

Playing a Tutorial Video

This machine provides tutorial videos on how to use the machine.

- ① Press .
- ② Press .
- ③ Select the category and the tutorial video.

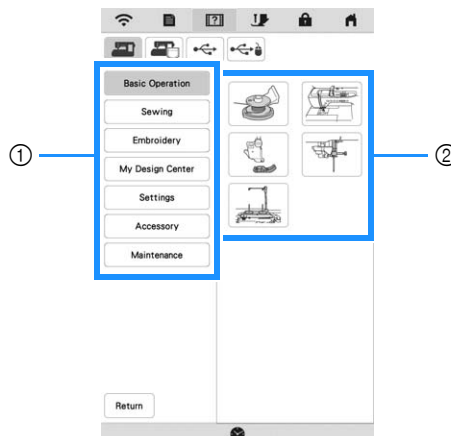

- ① Category
- ② Tutorial video

4 Play the tutorial video.

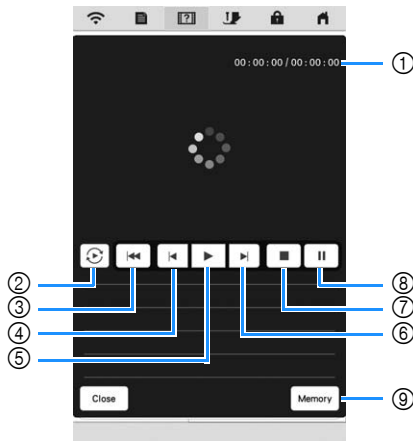

- ① Number of seconds elapsed/Total number of seconds
- ② Repeat
- ③ Return to beginning
- ④ Skip back 10 seconds
- ⑤ Play
- ⑥ Skip forward 10 seconds
- ⑦ Stop
- ⑧ Pause
- ⑨ Save to machine (when playing from USB media).

A video can be saved to (favorites) of the machine, from where it can be played. When playing from the machine's memory, changes to . Press to delete the video.

Note

- The specifications shown in the movie may differ from the ones on the actual product, in details.

5 After you are finished playing the video, press .

■ Playing MPEG-4 (MP4) Videos

Your MP4 videos can be played from USB media. In addition, the MP4 video can be saved to the machine so that a tutorial video on creating a project, for example, can be viewed at any time. For details on supported file extensions, refer to "SPECIFICATIONS" on page 192.

Memo

- Some type of MP4 file cannot be played with the machine.

1 Press .

2 Press .

3 Select the device where the video is saved.

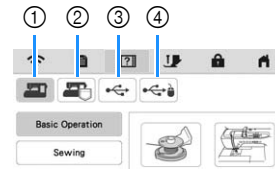

- ① Tutorial videos
- ② Videos saved on the machine (favorites)
- ③ Videos from USB media plugged into the USB port
- ④ Videos from USB media plugged into the USB port for mouse

4 Select the video that you want to play.

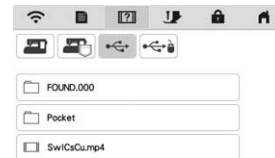

Note

- Long file names may be shortened when they are displayed.

5 Play the video.

* Use the operation keys as described in "Playing a Tutorial Video" on page 31.

6 After you are finished playing the video, press .

Using the Stitch Pattern Explanation Function

If you want to know more about the uses of a stitch pattern, select the pattern and press and then to see an explanation of the stitch selection.

Example: Displaying information about

1 Press .

2 Press .

3 Press .

→ The screen shows information.

4 Press to return to the original screen.

WIRELESS NETWORK CONNECTION FUNCTIONS

This machine supports a wireless network connection. Using this function, an embroidery pattern edited in embroidery editing software (PE-DESIGN 11) with wireless transfer functions can be transferred to the machine from a computer. Embroidery patterns can be transferred from the machine to the embroidery editing software. The machine and computer must be connected to the same network. For detailed procedures, refer to the manual for the embroidery editing software. The wireless network must be set up and enabled to use the special application to transfer images to the embroidery machine.

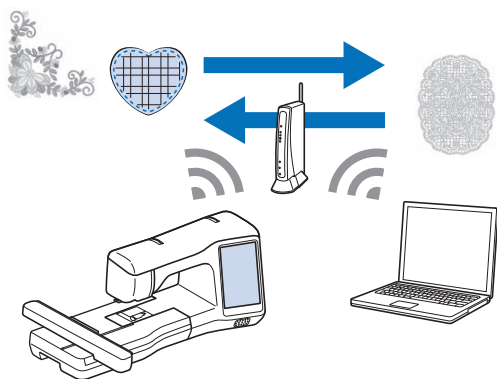

Enabling a Wireless Network Connection

The machine can be connected to your wireless network.

- 1 Press .
- 2 Press .
- 3 Set [Wireless LAN Enable] to [ON].

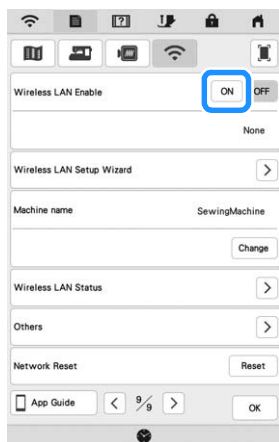

→ The machine begins to emit the wireless network signal.

Requirements for a Wireless Network Connection

The wireless network connection complies with IEEE 802.11 n/g/b standards and uses the 2.4 GHz frequency.

Memo

- A wireless network cannot be set up with WPA/WPA2 Enterprise.

Setting Up the Wireless Network Connection

There are multiple ways to set up the wireless network connection. We recommend the method that uses the wizard on this machine.

Using the Wizard to Set Up the Wireless Network Connection

- 1 In order to connect your machine to a wireless network, the security information (SSID and network key) for your home network will be required. The network key may also be called a password, security key or encryption key. First, find your security information and note it.

SSID	Network Key (Password)

Memo

- The wireless network connection cannot be set up if you do not have the security information.
- How to find the security information
 - ① Check the manual provided with your home network.
 - ② The default SSID may be the manufacturer's name or the model name.
 - ③ If you cannot find the security information, contact the manufacturer of the router, your network administrator or your Internet provider.

- 2 Press  beside [Wireless LAN Setup Wizard].

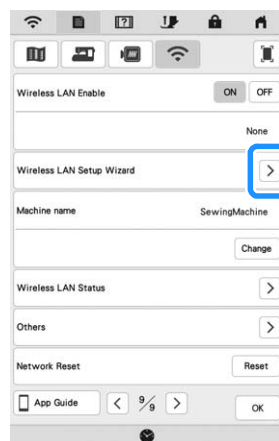

→ A list of available SSIDs appears.

3 Press > beside the SSID that was noted.



→ The screen for entering the network key (password) appears.

Memo

- If the SSID that was noted does not appear in the list, press .
- If the SSID that was noted is not displayed, specify it as described below.
 - ① Select in the list of SSIDs.
 - ② Enter the desired network SSID, and then press .
 - ③ Select the authentication method and encryption mode.
- If the machine had already been connected to the home network, press , and then select the saved SSID.

4 Enter the network key (password) that was noted, and then press .

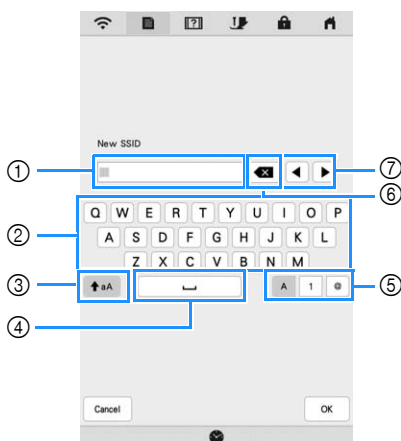

- ① Text input area
- ② Character keys
- ③ Caps key
- ④ Space key
- ⑤ Letters/numbers/symbols key
- ⑥ Backspace key (Deletes the character at the cursor's position.)
- ⑦ Cursor keys (Move the cursor to the left or right.)

5 When the following message appears, press .

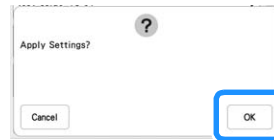

→ When a connection is established, the following message appears.

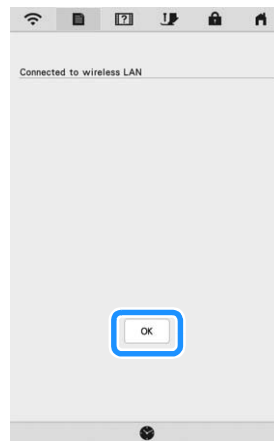

6 Press to exit the setup.

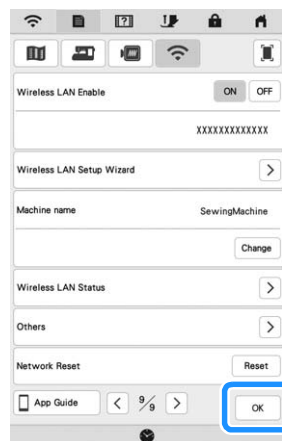

Memo

- While connected, the signal strength is indicated by the icon in the upper-left corner of the display.
- Once a wireless network connection has been set up, a connection will be established each time the machine is turned on. However, [Wireless LAN Enable] in the network settings screen must remain set to [ON].

■ Using the [Others] Menu To Set Up the Wireless Network Connection

The [Others] menu contains the following items.

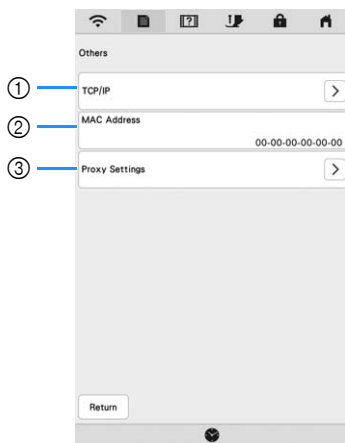

- ① TCP/IP settings can be manually entered.
- ② Shows the MAC address.
- ③ Use when proxy settings are required.

CONNECTING THE ACCESSORY TO THE MACHINE

Using a USB Mouse (Sold Separately)

The USB mouse, connected to the machine, can be used to perform a variety of operations in the screens. Connect a USB mouse to the USB port.

Memo

- If a mouse other than the optional USB mouse is used, it may not perform as described in this Operation Manual.

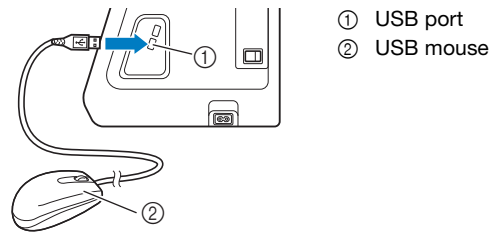

Note

- Only the left mouse button can be used to perform operations. Double-clicking has no effect. No other buttons can be used.
- The mouse pointer does not appear in the screen saver or opening screen.

■ Clicking a Key

When the mouse is connected, the pointer appears on the screen. Move the mouse to position the pointer over the desired key, and then click the left mouse button.



- ① Pointer

WINDING/INSTALLING THE BOBBIN

Winding the Bobbin

⚠ CAUTION

- The included bobbin was designed specifically for this machine. If bobbins from other models are used, the machine will not operate correctly. Use only the included bobbin or bobbins of the same type (part code: SA156, SFB: XA5539-151 / 115J05E0001, SFB: 115J05E7001). SA156 is Class 15 type bobbin.

■ Using the Supplemental Spool Pin

With this machine, you can wind the bobbin during sewing. While using the main spool pin to sew or embroider, you can conveniently wind the bobbin using the supplemental spool pin.

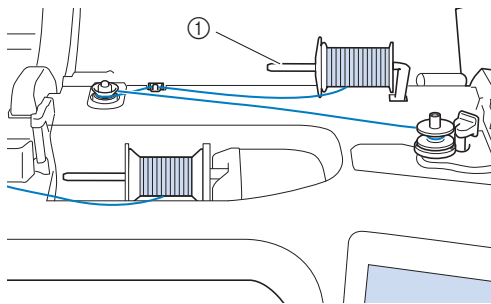

① Supplemental spool pin

1 Turn the main power to ON and open the top cover.

2 Align the groove in the bobbin with the spring on the bobbin winder shaft, and set the bobbin on the shaft.

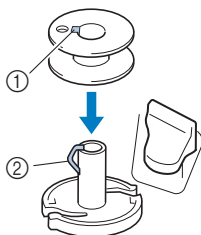

① Groove in the bobbin
② Spring on the bobbin winder shaft

3 Place the spool of thread for the bobbin and the spool cap onto the supplemental spool pin.

Slide the spool onto the supplemental spool pin so that the thread unwinds to the front from the bottom. Otherwise the thread may become tangled around the supplemental spool pin.

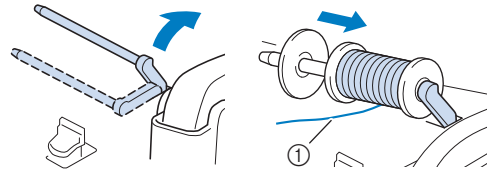

① The thread unwinds to the front from the bottom.

4 Slide the spool cap onto the spool pin as far as possible to the right, with the rounded side on the left.

⚠ CAUTION

- If the spool or the spool cap is not installed correctly, the thread may become tangled around the spool pin, causing the needle to break.
- Three spool cap sizes are available, allowing you to choose a spool cap that best fits the size of spool being used. If the spool cap is too small for the spool being used, the thread may catch on the slit in the spool or the machine may be damaged. When using mini king thread spool, use the thread spool insert (mini king thread spool). For details on thread spool insert (mini king thread spool), refer to "Memo" on page 37.



Memo

- When using the spool as shown below, use the small spool cap, and leave a small space between the cap and the spool.

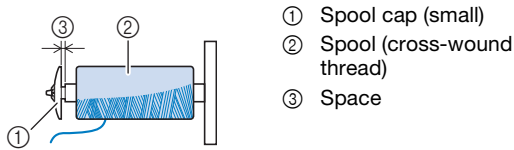

- When using thread that winds off quickly, such as transparent nylon thread or metallic thread, place the spool net over the spool before placing the spool of thread onto the spool pin. If the spool net is too long, fold it to fit the size of the spool. When threading the spool with the spool net on, make sure that about 5 cm (2 inches) of thread is pulled out. It may be necessary to adjust the thread tension when using the spool net.

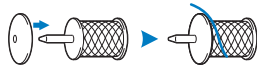

- If a spool of thread whose core is 1.2 cm (approx. 1/2 inch) in diameter and 7.5 cm (approx. 3 inches) high is inserted onto the spool pin, use the thread spool insert (mini king thread spool).

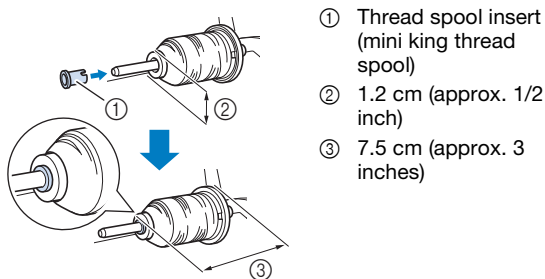

- 5** With your right hand, hold the thread near the thread spool. With your left hand, hold the end of the thread, and use both hands to pass the thread through the thread guide.

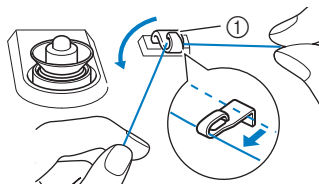

- 6** Pass the thread around the pretension disk making sure that the thread is under the pretension disk.

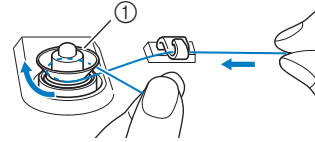

- Make sure that the thread passes under the pretension disk.

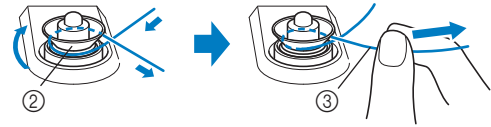

- ③ Pull it in as far as possible.

- 7** Wind the thread clockwise around the bobbin 5 or 6 times, pass the thread through the guide slit in the bobbin winder seat, and then pull the thread to cut it.

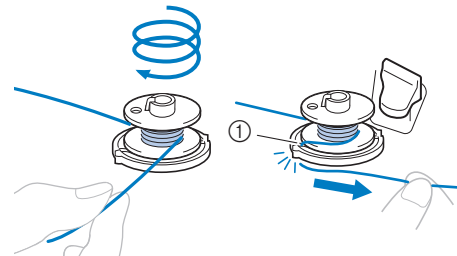

Note

- Be sure to wind the thread clockwise around the bobbin, otherwise the thread may become wrapped around the bobbin winder shaft.

CAUTION

- Be sure to cut the thread as described. If the bobbin is wound without cutting the thread using the cutter built into the guide slit in the bobbin winder seat, the thread may become tangled in the bobbin or the needle may bend or break when the bobbin thread starts to run out.

8 Set the bobbin winding switch to the left, until it clicks into place.

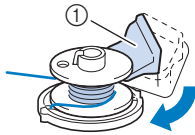

① Bobbin winding switch
→ The bobbin winding window appears.

9 Press **Start**.



→ Bobbin winding starts. The bobbin stops rotating when bobbin winding is completed. The bobbin winding switch will automatically return to its original position.

→ **Start** changes to **Stop** while the bobbin is winding.

→ You can change the winding speed by pressing **-** (to decrease) or **+** (to increase) in the bobbin winding window.

Note

- The sound of winding the bobbin with stiff thread, such as nylon thread for quilting, may be different from the one produced when winding normal thread; however, this is not a sign of a malfunction.
- When winding transparent nylon thread on the bobbin, stop bobbin winding when the bobbin is 1/2 to 2/3 full. If the bobbin was fully wound with transparent nylon thread, it may not be wound neatly, or sewing performance may suffer. In addition, extreme pressure may be applied to the bobbin, it may not be possible to remove the bobbin from the bobbin winder shaft, or the bobbin may break.



Memo

- Press **OK** to minimize the bobbin winding window. Then, you can perform other operations, such as selecting a stitch or adjusting the thread tension, while the bobbin is being wound.
- Press **Bobbin Winding** (in top right of the LCD screen) to display the bobbin winding window again.



10 After bobbin winding is finished, cut the thread with scissors and remove the bobbin.

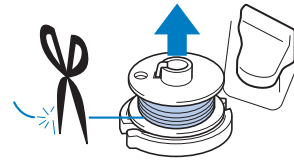

Using the Spool Pin

You can use the main spool pin to wind the bobbin before sewing. You cannot use this spool pin to wind the bobbin while sewing.

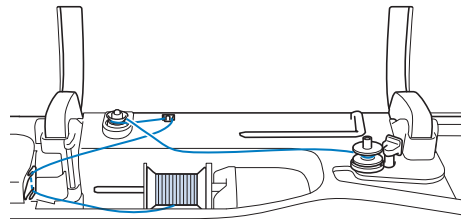

1 Turn the main power to ON and open the top cover.

2 Align the groove in the bobbin with the spring on the bobbin winder shaft, and set the bobbin on the shaft.

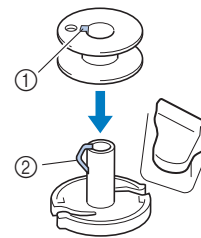

- ① Groove in the bobbin
- ② Spring on the bobbin winder shaft

3 Remove the spool cap and place the spool of thread for the bobbin onto the spool pin.

Slide the spool onto the spool pin so that the thread unwinds to the front from the bottom.

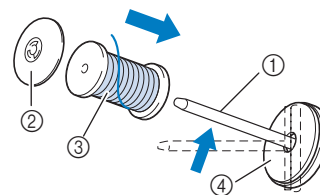

- ① Spool pin
- ② Spool cap
- ③ Spool of thread
- ④ Spool felt

4 Slide the spool cap onto the spool pin as far as possible to the right, with the rounded side on the left.

5 While holding the thread with both hands, pass the thread through grooves of the thread guide plate.

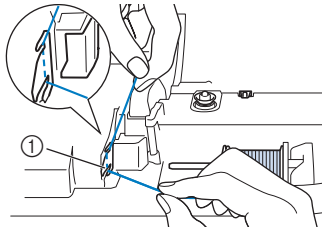

① Thread guide plate

6 Pass the thread through the thread guide.

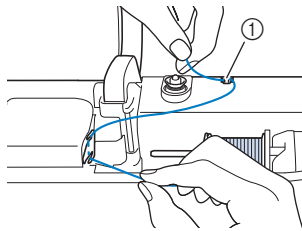

① Thread guide

7 Pass the thread around the pretension disk making sure that the thread is under the pretension disk.

Pull the thread as far as possible.

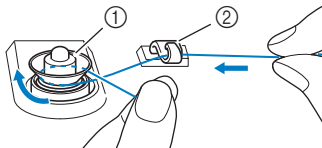

① Pretension disk
② Thread guide

8 Follow steps **7** through **10** on page 37 through page 38.

■ Using the Spool Stand (Included with Some Models)

To wind thread on the bobbin while the spool stand is installed, pass the thread from the spool through the thread guide on the telescopic thread guide, and then wind the bobbin according to steps **5** through **10** of "Using the Supplemental Spool Pin" on page 37 to page 38.

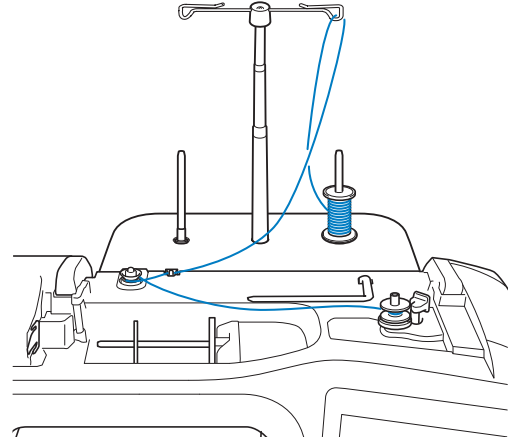

⚠ CAUTION

- When winding thread on the bobbin, do not cross the bobbin winding thread with the upper thread in the thread guides.

Setting the Bobbin

⚠ CAUTION

- Use a bobbin that has been correctly wound with thread, otherwise the needle may break or the thread tension will be incorrect.



- Before inserting or changing the bobbin, be sure to press  in the LCD to lock all keys and buttons. Otherwise injuries may occur if the “Start/Stop” button or any other button is pressed and the machine starts sewing.

- 1 Press  to lock all keys and buttons and raise the presser foot.

* If the message [OK to automatically lower the presser foot?] appears on the LCD screen, press

 to continue.

- 2 Slide the bobbin cover latch to the right and remove the bobbin cover.

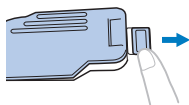

- 3 Insert the bobbin into the bobbin case so that the thread unwinds to the left.

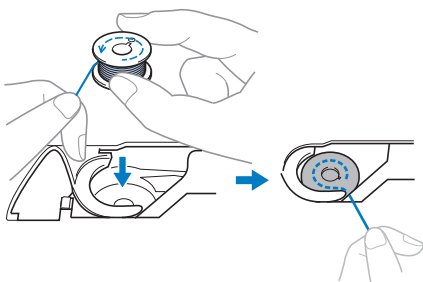

- 4 Lightly hold down the bobbin with your right hand (①), and then guide the end of the thread around the tab of the needle plate cover with your left hand (②).

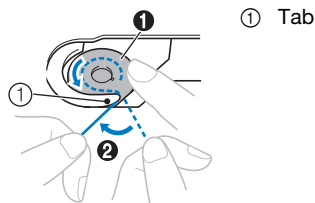

⚠ CAUTION

- Be sure to hold down the bobbin with your finger and unwind the bobbin thread correctly, otherwise the thread may break or the thread tension will be incorrect.

- 5 While lightly holding down the bobbin with your right hand (①), guide the thread through the slit in the needle plate cover (②) and lightly pull it with your left hand (③).

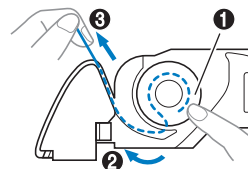

Memo

- By guiding the thread around the tab of the needle plate cover, passing the thread as shown by ② in this illustration, then lightly pulling the thread at ③, the thread will enter the tension spring of the bobbin case to apply the appropriate tension to the bobbin thread during sewing.

- 6 While lightly holding down the bobbin with your right hand (①), continue guiding the thread through the slit with your left hand (②). Then, cut the thread with the cutter (③).

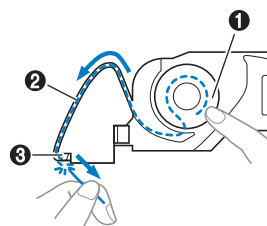

Memo

- Be sure to complete the bobbin threading correctly according to these instructions. If the thread is simply placed in the slit in the needle plate cover, the bobbin thread will not be correctly threaded, resulting in poor sewing performance or incorrect thread tension.

7 Reattach the bobbin cover.

Insert the tab of the bobbin cover into the notch of the needle plate cover, and then lightly press down on the right side.

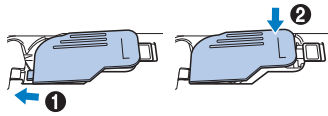
**Memo**

- You can begin sewing without pulling up the bobbin thread. If you wish to pull up the bobbin thread before starting to sew, pull up the thread according to the procedure in “Pulling Up the Bobbin Thread” on page 41.

8 Press  to unlock all keys and buttons.**Pulling Up the Bobbin Thread**



There may be some sewing applications where you want to pull up the bobbin thread; for example, when making gathers, darts, or doing free motion quilting or embroidery.

Memo

- You can pull up the bobbin thread after threading the upper thread (“UPPER THREADING” on page 42).

1 Follow steps 1 to 3 in “Setting the Bobbin” on page 40 for installing the bobbin into the bobbin case.**2 Guide the bobbin thread through the groove, following the arrow in the illustration.**

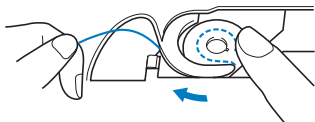
- Do not cut the thread with the cutter.
- Do not replace the bobbin cover.

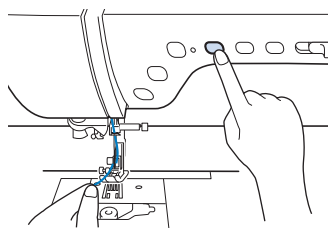
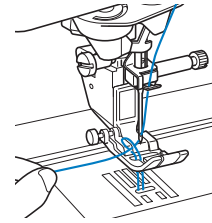
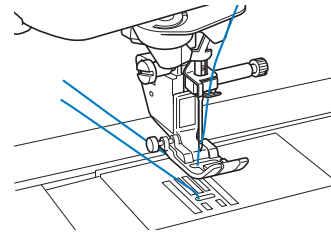
**3 Press  to unlock all keys and buttons.****4 While lightly holding the upper thread with your left hand, press  (Needle position button) twice to lower and then raise the needle.****5 Gently pull the upper thread. A loop of the bobbin thread will come out of the hole in the needle plate.****6 Pull up the bobbin thread, pass it under the presser foot and pull it about 10 cm (4 inches) toward the back of the machine, making it even with the upper thread.****7 Reattach the bobbin cover.**

UPPER THREADING

Upper Threading

⚠ CAUTION

- Be sure to thread the machine properly. Improper threading can cause the thread to tangle and break the needle, leading to injury.
- When using the walking foot, the side cutter or accessories not included with this machine, attach the accessory to the machine after threading the machine.
- The automatic threading function cannot be used with the wing needle or the twin needle.

Using  (Automatic threading button) may result in damage to the machine.

📖 Memo

- The automatic threading function can be used with home sewing machine needle sizes 75/11 through 100/16.
- The following threads are incompatible with the needle threader. Manually pass the thread through the eye of the needle.
 - Speciality thread such as metallic thread
 - Transparent nylon thread

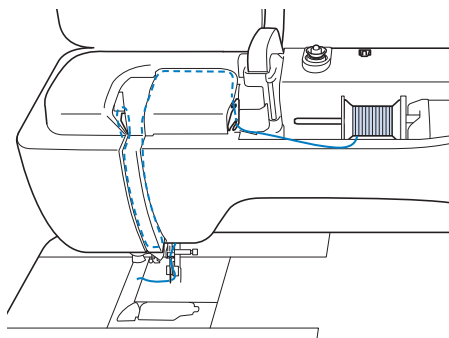

1 Turn the main power to ON.

2 Press  (Presser foot lifter button) to raise the presser foot.

→ The upper thread shutter opens so the machine can be threaded.

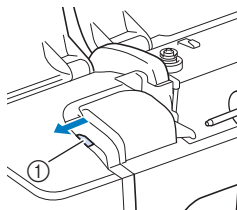

① Upper thread shutter

3 Press  (Needle position button) to raise the needle.

Note

- If you try to thread the needle automatically without raising the needle, the needle may not be thread correctly and the needle threader may be damaged.

4 Remove the spool cap and place the spool of thread onto the spool pin.

Slide the spool onto the spool pin so that the thread unwinds to the front from the bottom.

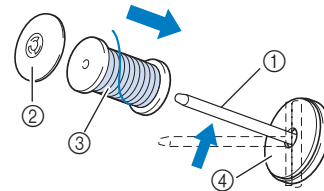

- ① Spool pin
- ② Spool cap
- ③ Spool of thread
- ④ Spool felt

5 Slide the spool cap onto the spool pin as far as possible to the right, with the rounded side on the left.

⚠ CAUTION

- Choose a spool cap that best fits the size of spool being used. For more information, refer to "Memo" on page 37.

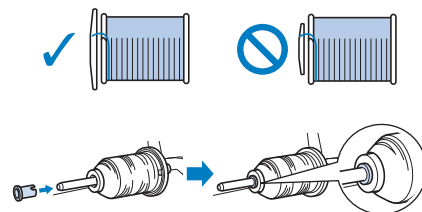

- If the spool or the spool cap is not positioned correctly, the thread may become tangled around the spool pin or the needle may break.

6 While holding the thread with both hands, pass the thread through grooves of the thread guide plate.

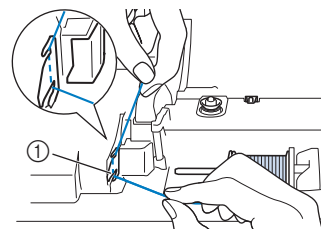

① Thread guide plate

- 7** While holding the thread in your right hand, pass the thread through the thread guide in the direction indicated.

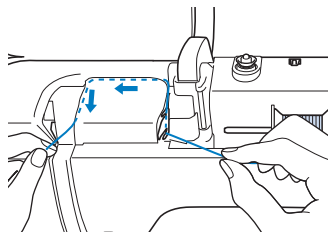

- 8** Guide the thread down, up, then down through the groove, as shown in the illustration.

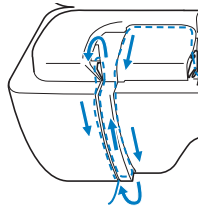

Memo

- Look in the upper groove area to check if the thread catches on the thread take-up lever visible inside the upper groove area.

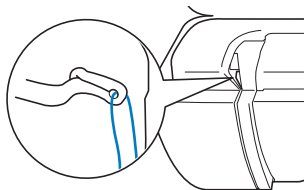

- 9** Pass the thread through the needle bar thread guide (marked "6") by holding the thread with both hands and guiding it as shown in the illustration.

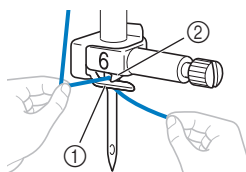

- ① Needle bar thread guide
- ② Tab

- 10** Pass the thread through the notch in the thread guide. Then firmly pull the thread from front to back into the slit of the thread guide disk (marked "7").

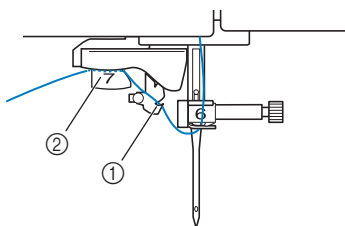

- ① Notch in thread guide
- ② Thread guide disk

- 11** Press  (Presser foot lifter button) to lower presser foot.

- 12** Pull the thread up through the thread cutter to cut the thread, as shown in the illustration.

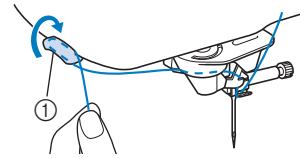

- ① Thread cutter

Note

- When using thread that quickly winds off the spool, it may be difficult to thread the needle if the thread is cut. Therefore, instead of using the thread cutter, pull out about 8 cm (3 inches) of thread after passing it through the thread guide disks (marked "7").

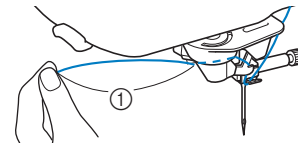



- ① About 8 cm (3 inches) or more

- 13** Press  (Automatic threading button) to have the machine automatically thread the needle.

→ The thread passes through the eye of the needle.

Memo

- When  (Automatic threading button) is pressed, the presser foot will be automatically lowered. After threading is finished, the presser foot moves back to the position before  (Automatic threading button) was pressed.

Note

- Some needles and threads cannot be threaded with the needle threader. In this case, instead of using the needle threader after passing the thread through the needle bar thread guide (marked "6"), manually pass the thread through the eye of the needle from the front.

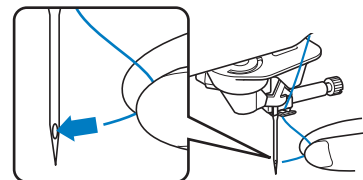

- 14** Carefully pull the end of the thread that was passed through the eye of the needle.

- * If a loop was formed in the thread passed through the eye of the needle, carefully pull on the loop of thread through to the back of the needle.

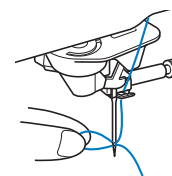

- 15** Raise the presser foot lever and pull out about 10 cm (4 inches) of the thread, and then pass it under the presser foot toward the rear of the machine.

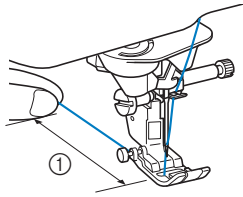

- ① About 10 cm (4 inches)

Memo

- If the needle could not be threaded or the thread was not passed through the needle bar thread guides, perform the procedure again starting from step ③. Then, pass the thread through the eye of the needle after step ⑨.

Using the Vertical Spool Pin (Included with Some Models)

Use the vertical spool pin when using an irregularly shaped thread spool, and when sewing with metallic thread.

- 1** Insert the vertical spool pin onto the bobbin winder shaft.

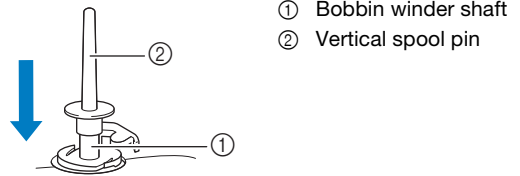

- ① Bobbin winder shaft
② Vertical spool pin

- 2** Install the spool felt and the thread spool in that order, and then thread the upper thread.

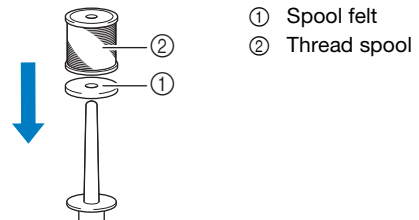

- ① Spool felt
② Thread spool

Memo

- When setting the thread spool, set it so that the thread winds off from the front of the spool.
- If using metallic thread, we recommend that you use a 90/14 home sewing machine needle.
- This method keeps the thread from twisting as it comes off the spool pin.

Using the Twin Needle Mode

The twin needle can only be used for stitch patterns that show  after being selected. Before you select a stitch pattern, make sure the stitch can be sewn in the twin needle mode (refer to the "STITCH SETTING CHART" on page 194).

CAUTION

- Only use a genuine Brother twin needle.
- When using the twin needle, it is recommended to use presser foot "J".

- 1 Press  to lock all keys and buttons and then install the twin needle ("CHANGING THE NEEDLE" on page 48).

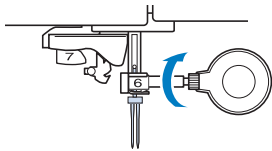

- 2 Thread the machine for the first needle according to the procedure for threading a single needle ("Upper Threading" on page 42).

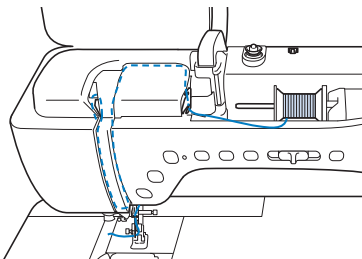

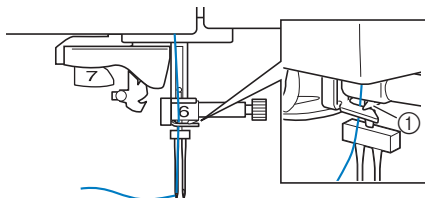

- 3 Pass the thread through the needle bar thread guides on the needle bar, then thread the needle on the left side manually.



- ① Needle bar thread guide

Note

-  (Automatic threading button) cannot be used. Manually thread the twin needle from front to back.
- Using  (Automatic threading button) may result in damage to the machine.

- 4 Pull up the supplemental spool pin and set it in the up position. Place the additional spool of thread on the supplemental spool pin, so that the thread unwinds from the front. Push the spool cap onto the spool pin as far as possible to secure the thread spool.

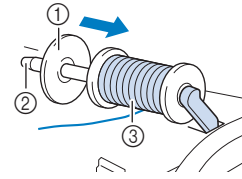

- ① Spool cap
② Spool pin
③ Spool of thread

- 5 Hold the thread from the spool with both hands, and place the thread in the thread guide.

* Do not place the thread in the pretension disks.

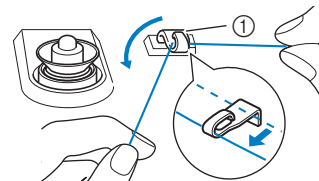

- ① Thread guide

- 6 While holding the thread from the spool, pull the thread through the lower notch in the thread guide plate, then through the upper notch. Hold the end of the thread with your left hand, and then guide the thread through the groove, following the arrows in the illustration.

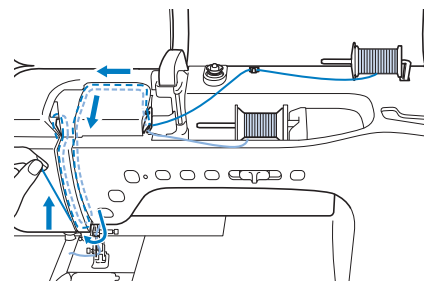

- 7 Continue threading; however, do not pass the thread in the needle bar thread guide "6" on the needle bar. Thread the needle on the right side.

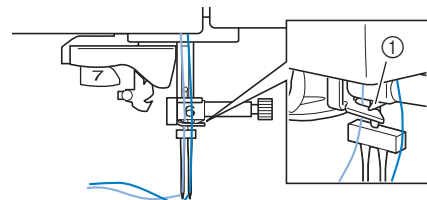

- ① Needle bar thread guide

- 8 Press  to unlock all keys and buttons.

- 9 Select a stitch pattern.

- * Refer to "Basic Sewing" on page 56 for selecting a stitch pattern.
- * Refer to "STITCH SETTING CHART" on page 194 for the proper stitch to use with presser foot "J".

10 Press  to select the twin needle mode.

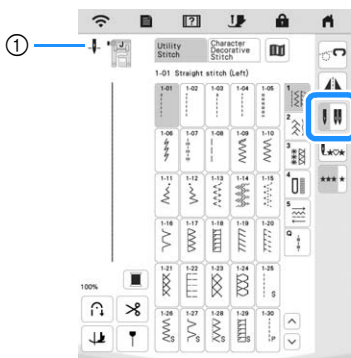

① Single needle/twin needle position setting display
 →  appears.

CAUTION

- Be sure to set the twin needle mode when using the twin needle. Using the twin needle while the machine is in single needle mode could cause the needle to break, resulting in damage.

11 Start sewing.

Sample of Twin Needle Sewing

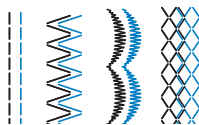

Using the Spool Stand

The included spool stand is useful when using thread on spools with a large diameter (cross-wound thread). This spool stand can hold two spools of thread.

■ Using the Spool Stand (Included with Some Models)

- Be sure to use a spool cap that is slightly larger than the spool. If the spool cap that is used is smaller or much larger than the spool, the thread may catch and sewing performance may suffer.
- When using thread on a thin spool, place the included spool felt on the spool pin, place the thread spool on the spool pin so that the center of the spool is aligned with the hole at the center of the spool felt, and then insert the spool cap onto the spool pin.

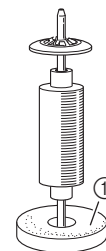
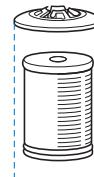

① Spool felt

- When using thread on a cone spool, use the spool holder. When using cone shaped thread spool with other than cotton thread, it is not necessary to use spool caps.

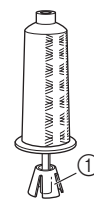

① Spool holder

- Depending on the size of spool or the amount of thread remaining, choose the appropriate sized spool cap (large or medium). Spool cap (small) cannot be used with the spool cap base.

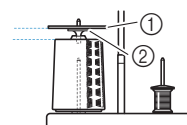

① Spool cap
 ② Spool cap base

1 Attach the spool stand to the machine. (page 20)

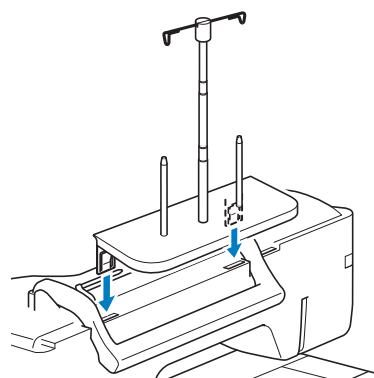

- 2** Place the spool of thread on the spool pin so that the thread feeds off the spool clockwise. Firmly insert the spool cap onto the spool pin.

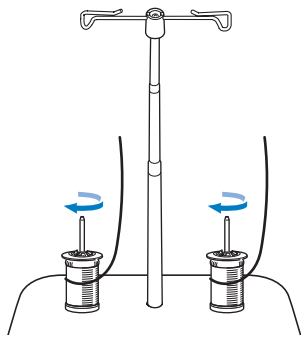

Note

- When using two spools of thread, make sure that both spools are feeding in the same direction.
- Make sure that the spools do not touch each other, otherwise the thread will not feed off smoothly, the needle may break, or the thread may break or become tangled. In addition, make sure that the spools do not touch the telescopic thread guide at the center.
- Make sure that the thread is not caught under the spool.

- 3** Pull the thread off the spool. Pass the thread from the back to the front through the thread guides at the top.

When using thread that quickly feeds off the spool, such as metallic thread, use the enclosed ring to prevent the thread from becoming entangled.

Threading sequence; Pull the thread from the spool, place the thread through the ring from the bottom up (1), into the thread guide (2) and through the ring from the top down (3). When using the ring, do not use the spool cap base.

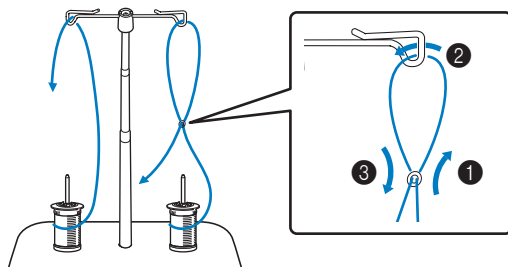

Note

- Guide the thread so that it does not become entangled with the other thread.
- After feeding the thread as instructed, wind any excess thread back onto the spool, otherwise the excess thread will become tangled.

- 4** Pass the thread through the machine's thread guide from the right to the left.

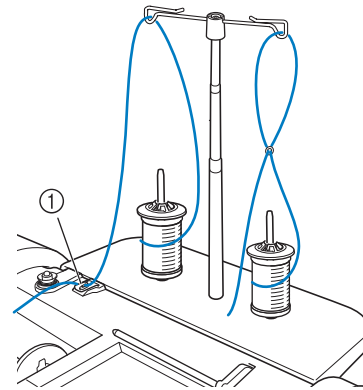



① Thread guide

- 5** Thread the machine according to the steps 6 to 15 of "Upper Threading" on page 42.

CHANGING THE NEEDLE

⚠ CAUTION

- Always press  on the screen to lock all keys and buttons before changing the needle. If  is not pressed and the “Start/Stop” button or another operation button is pressed accidentally, the machine will start and injury may result.
- Use only home sewing machine needles. Other needles may bend or break and may cause injury.
- Never use a bent needle. A bent needle will easily break and may cause injury.

Memo

- To check the needle correctly, place the flat side of the needle on a flat surface. Check the needle from the top and the sides. Throw away any bent needles.

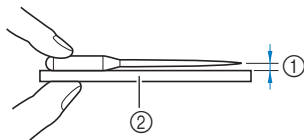

- ① Parallel space
- ② Flat surface (bobbin cover, glass, etc.)

1 Press  (Needle position button) to raise the needle.

2 Press  to lock all keys and buttons.

- * If the message [OK to automatically lower the presser foot?] appears on the LCD screen, press

 to continue.

Note

- Before replacing the needle, cover the hole in the needle plate with fabric or paper to prevent the needle from falling into the machine.

3 Remove the presser foot. (page 50)

4 Use the disc-shaped screwdriver to turn the needle clamp screw toward you (counterclockwise) to loosen the screw. Remove the needle.

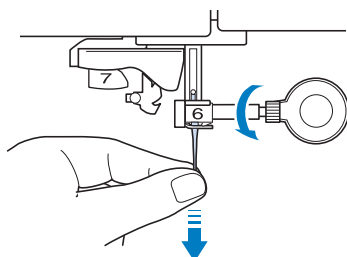

5 With the flat side of the needle facing the back, insert the new needle all the way to the top of the needle stopper (viewing window) in the needle clamp. Use the disc-shaped screwdriver to securely tighten the needle clamp screw.

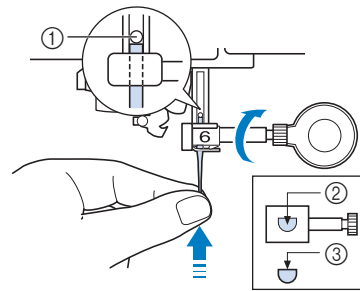

- ① Needle stopper
- ② Hole for inserting the needle
- ③ Flat side of the needle

⚠ CAUTION

- Be sure to push in the needle until it touches the stopper, and securely tighten the needle clamp screw with the disc-shaped screwdriver. If the needle is not completely inserted or the needle clamp screw is loose, the needle may break or the machine may be damaged.

6 Attach the presser foot. (page 50)

7 Press  to unlock all keys and buttons.

Memo

- The automatic threading function can be used with home sewing machine needle sizes 75/11 through 100/16.

FABRIC/THREAD/NEEDLE COMBINATIONS

- Needles that can be used with this machine: Home sewing machine needles (size 65/9 - 100/16)
* The larger the number, the larger the needle. As the numbers decrease, the needles get finer.
- Thread that can be used with this machine: 30 - 90 weight
* Never use thread of 20 weight or lower. It may cause machine to malfunction.
* The smaller the number, the heavier the thread. As the numbers increase, the thread gets finer.
- The machine needle and thread that should be used depends on the type and thickness of the fabric. Refer to the following table when choosing the thread and needle appropriate for the fabric that you wish to sew.
 - The combinations shown in the table provide a general guideline. Be sure to sew trial stitches on the actual number of layers and type of fabric to be used in your project.
 - The machine needles are consumables. For safety and best results, we recommend replacing the needle regularly. For details on when to replace the needle, refer to "CHANGING THE NEEDLE" on page 48.
- In principle, use a fine needle and thread with lightweight fabrics, and a larger needle and heavier thread with heavyweight fabrics.
- Select a stitch appropriate for the fabric, and then adjust the stitch length. When sewing lightweight fabrics, make the stitch length finer (shorter). When sewing heavyweight fabrics, make the stitch length coarser (longer). (page 62)
When sewing stretch fabrics, refer to "Sewing Stretch Fabrics" on page 70.

Fabric Type/Application		Thread		Size of needle	Stitch length mm (inch)
		Type	Weight		
Lightweight fabrics	Lawn, georgette, challis, organdy, crepe, chiffon, voile, gauze, tulle, lining, etc.	Polyester thread	60 - 90	65/9 - 75/11	Fine stitches 1.8-2.5 (1/16-3/32)
		Cotton thread Silk thread	50 - 80		
Medium weight fabrics	Broadcloth, taffeta, gabardine, flannel, seersucker, double gauze, linen, terry cloth, waffle weave, sheeting, poplin, cotton twill, satin, quilting cotton, etc.	Polyester thread	60 - 90	75/11 - 90/14	Regular stitches 2.0-3.0 (1/16-1/8)
		Cotton thread Silk thread	50 - 60		
Heavyweight fabrics	Denim (12 ounces or more), canvas, etc.	Polyester thread Cotton thread	30	100/16	Coarse stitches 2.5-4.0 (3/32-3/16)
		Polyester thread Cotton thread Silk thread	60 30 - 50	90/14 - 100/16	
	Denim (12 ounces or more), canvas, tweed, corduroy, velour, melton wool, vinyl-coated fabric, etc.				
Stretch fabrics (knit fabrics, etc.)	Jersey, tricot, T-shirt fabric, fleece, interlock, etc.	Polyester thread Cotton thread Silk thread	50	Ball point needle 75/11 - 90/14	Setting appropriate for the fabric thickness
For top-stitching		Polyester thread	30	90/14 - 100/16	Setting appropriate for the fabric thickness
		Cotton thread	50 - 60	75/11 - 90/14	

■ Transparent Nylon Thread

Use a home sewing machine topstitching needle, regardless of the fabric or thread.

■ Embroidery Needles

Use a ball point needle 75/11.

■ Sewing Character Stitch Patterns and Decorative Stitch Patterns (Needles and Threads)

When sewing lightweight, medium weight or stretch fabrics, use a ball point needle (gold colored) 90/14. When sewing heavyweight fabrics, use a home sewing machine needle 90/14.



In addition, #50 to #60 thread should be used.

⚠ CAUTION

- The appropriate fabric, thread and needle combinations are shown in the preceding table. If the combination of the fabric, thread and needle is not correct, particularly when sewing heavy fabrics (such as denim) with thin needles (such as 65/9 to 75/11), the needle may bend or break. In addition, the stitching may be uneven or puckered or there may be skipped stitches.

CHANGING THE PRESSER FOOT

⚠ CAUTION

- Always press  on the screen to lock all keys and buttons before changing the presser foot. If  is not pressed and the “Start/Stop” button or another button is pressed, the machine will start and may cause injury.
- Always use the correct presser foot for the selected stitch pattern. If the wrong presser foot is used, the needle may strike the presser foot and bend or break, and may cause injury.
- Only use presser feet made for this machine. Using other presser feet may lead to accident or injury.
- Make sure that the presser foot is installed in the correct direction, otherwise the needle may strike the presser foot, breaking the needle and causing injuries.

Replacing the Presser Foot

1 Press  (Needle position button) to raise the needle.

2 Press  to lock all keys and buttons.

- * If the message [OK to automatically lower the presser foot?] appears on the LCD screen, press  to continue.

3 Raise the presser foot lever.

4 Press the black button on the presser foot holder and remove the presser foot.

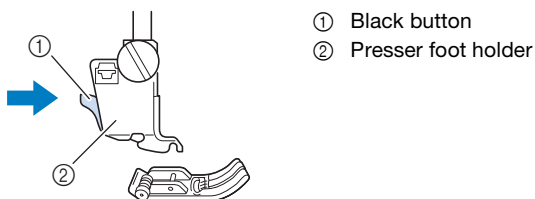

5 Place the new presser foot under the holder, aligning the foot pin with the notch in the holder. Lower the presser foot lever so that the presser foot pin snaps into the notch in the holder.

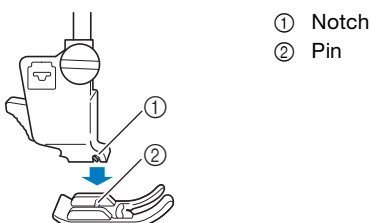

6 Raise the presser foot lever to check that the presser foot is securely attached.

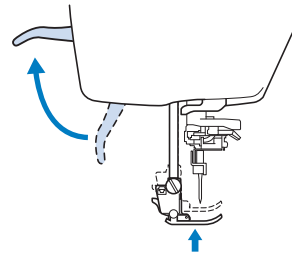

7 Press  to unlock all keys and buttons.

Attaching the Presser Foot with the Included Adapter

You can attach the presser feet using the included adapter and small screw.

For example, the walking foot, the free motion echo quilting foot “E” and so on.

Following procedure shows how to attach the walking foot as an example.



■ Attaching the Walking Foot (Sold Separately)

The walking foot holds the fabric between the presser foot and the feed dogs to feed the fabric. This enables you to have better fabric control when sewing difficult fabrics (such as quilted fabrics or velvet) or fabrics that slip (such as vinyl, leather, or synthetic leather).

Note

- When sewing with the walking foot, sew at medium to low speeds.
- The walking foot can only be used with straight or zigzag stitch patterns. Do not sew reverse stitches with the walking foot.

1 Follow the steps in “Replacing the Presser Foot” on page 50.

2 Loosen the screw of the presser foot holder to remove the presser foot holder.

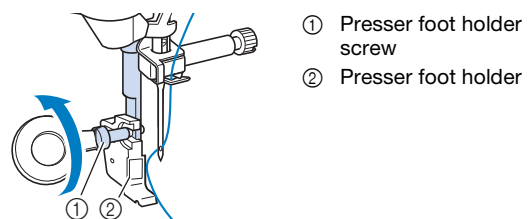

- 3** Remove the screw of the presser foot completely from the presser foot shaft.

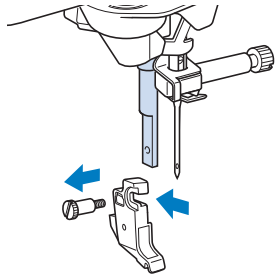

- 4** Set the adapter on the presser foot bar, aligning the flat side of the adapter opening with the flat side of the presser bar. Push it up as far as possible, and then tighten the screw securely with the disc-shaped screwdriver.

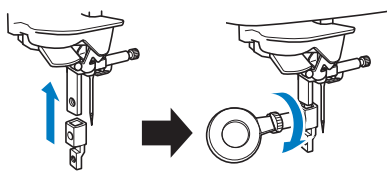

- 5** Turn the included small screw 2 or 3 times with your hand.

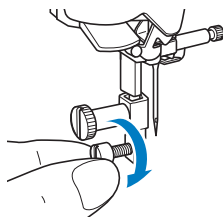

- 6** Set the operation lever of the walking foot so that the needle clamp screw is set in the fork. Position the shank of the walking foot on the presser foot bar.

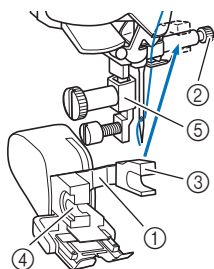

- ① Operation lever
- ② Needle clamp screw
- ③ Fork
- ④ Walking foot shank
- ⑤ Presser foot bar

- 7** Lower the presser foot lever. Insert the screw, and tighten the screw securely with the screwdriver.

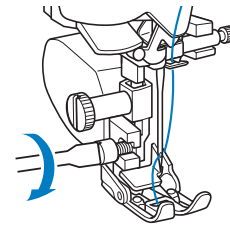

CAUTION

- Use the included screwdriver to tighten the screw securely. If the screw is loose, the needle may strike the presser foot and cause injury.
- Be sure to rotate the handwheel toward you (counterclockwise) to check that the needle does not strike the presser foot. If the needle strikes the presser foot, injury may result.

Using the Dual Feed Foot

Dual feed foot enables you to have best fabric control when sewing difficult fabrics that slip easily, such as quilted fabrics or fabrics that tend to stick to the bottom of a presser foot, such as vinyl, leather or synthetic leather.

Note

- When sewing with the dual feed foot, sew at medium to low speeds.

Memo

- When selecting stitches to be used with the dual feed foot, only the stitches that can be used will be activated on the display.

Attaching the Dual Feed Foot

- 1** Remove the presser foot. (page 50)
- 2** Loosen the screw of the presser foot holder to remove the presser foot holder.

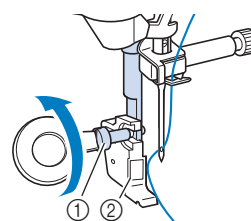

- ① Presser foot holder screw
- ② Presser foot holder

- 3 Position the dual feed foot to the presser foot bar by aligning the notch of the dual feed foot to the large screw.

Side view

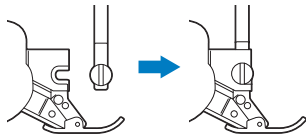

- 4 Hold the dual feed foot in place with your right hand, then using the disc-shaped screwdriver securely tighten the large screw.

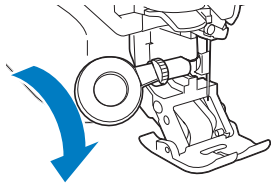

⚠ CAUTION

- Use the included screwdriver to firmly tighten the screw. If the screw is loose, the needle may strike the presser foot and possibly cause injury.

- 5 Plug the connector of the dual feed foot into the jack on the back of your machine.

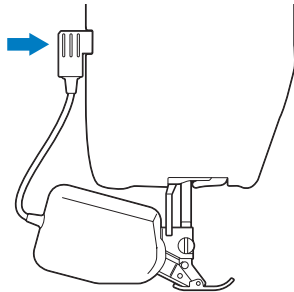

- 6 Press  to unlock all keys and buttons.
→ All keys and operation buttons are unlocked, and the previous screen is displayed.

■ Attaching/Detaching Toe

Attach the toe by aligning the pins with the notches and snap it into place.

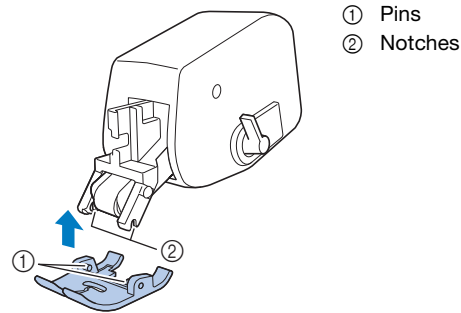

If you push down on the front and back part of the dual feed foot, the toe of the dual feed foot will snap off.

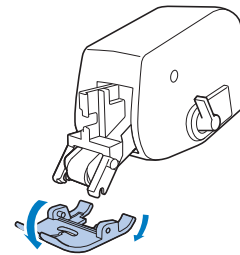

■ Using the Dual Feed Position Lever

When the feed position lever is up, the black roller belt on the dual feed is not engaged.

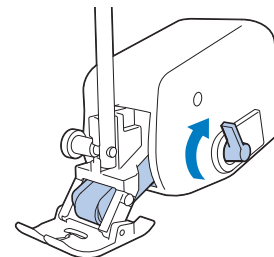

When the feed position lever is down, the black roller belt on the dual feed is engaged.

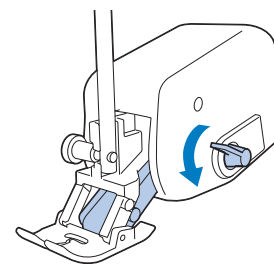

💡 Note

- Do not operate the lever while sewing.

■ Adjusting the Amount of Fabric Feeding from the Dual Feed Foot

The dual feed mechanism pulls the top fabric according to the set stitch length. With troublesome fabrics, fine tune the set length, by changing the dual feed feed adjustment in the settings screen.

Note

- As a default, some keys mentioned in the following procedures appear in light gray and are not available. To enable the keys for specifying the settings, attach the dual feed foot to the machine. The keys are enabled after the dual feed foot is detected.

1 Press .



→ The settings screen appears.



2 Press .

→ The sewing settings screen appears.

3 Display [Dual Feed Feed Adjustment] in the sewing settings screen.



4 Use  or  to increase or decrease the feeding of the top fabric.

- * Select [00] for sewing in most cases.
- * If the feed amount for the top fabric is too little, causing the fabric to be longer than the bottom fabric, press  to increase the feed amount for the top fabric.
- * If the feed amount for the top fabric is too much, causing the fabric to be shorter than the bottom fabric, press  to decrease the feed amount for the top fabric.

5 Press  to return to the original screen.



Chapter **2**
Sewing Basics

SEWING

CAUTION

- To avoid injury, pay special attention to the needle while the machine is in operation. Keep your hands away from moving parts while the machine is in operation.
- Do not stretch or pull the fabric during sewing. Doing so may lead to injury.
- Do not use bent or broken needles. Doing so may lead to injury.
- Do not attempt to sew over basting pins or other objects during sewing. Otherwise, the needle may break and cause injury.
- If stitches become bunched, lengthen the stitch length setting before continuing sewing. Otherwise, the needle may break and cause injury.
- This machine is equipped with a thread detection device. If the "Start/Stop" button is pushed before the upper threading is done, the machine will not operate properly. Also, depending on the stitch pattern selected, the machine may feed the fabric even if the needle is raised. This is due to the needle bar release mechanism. At these times, the machine will make a sound different from what is made during normal sewing. This is not the sign of a malfunction.

Stitch Types

Utility Stitches

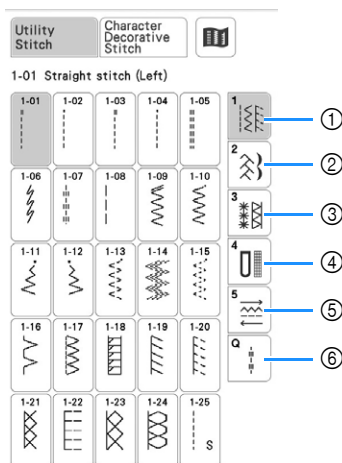

- ① Straight/Overcasting
- ② Decorative Stitches
- ③ Heirloom Stitches
- ④ Buttonholes/Bar tacks
- ⑤ Multi-directional
- ⑥ Sewing Quilting Stitches

Character/Decorative Stitches

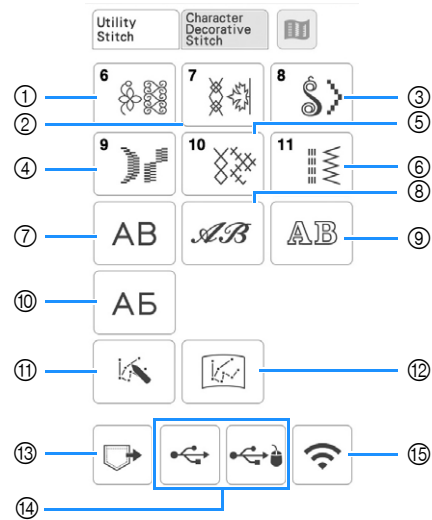



- ① Decorative stitch patterns
- ② 7mm decorative stitch patterns
You can set stitch length and width.
- ③ Satin stitch patterns
- ④ 7mm satin stitch patterns
You can set stitch length and width.
- ⑤ Cross stitch
- ⑥ Utility decorative stitch patterns
- ⑦ Alphabet characters (gothic font)
- ⑧ Alphabet characters (handwriting font)
- ⑨ Alphabet characters (outline)
- ⑩ Cyrillic font
- ⑪ MY CUSTOM STITCH (page 100)
You can design original stitches.
- ⑫ Stitch patterns stored in MY CUSTOM STITCH (page 103)
- ⑬ Stitch patterns saved in the machine's memory (page 99)
- ⑭ Stitch patterns saved in USB media (page 99)
- ⑮ Stitch patterns to be transferred via the wireless network (page 99)

Basic Sewing

Note

- First, perform a trial sewing, using a piece of fabric and thread that are the same as those used for your project.

- 1 Turn the main power to ON and press  to display the utility stitches, and press  (Needle position button) to raise the needle.

2 Select the category you want.

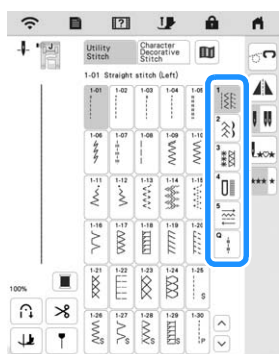

3 Press the key of the stitch you want to sew.

- For details on stitch patterns, refer to “STITCH SETTING CHART” on page 194.
- For details on the key functions, refer to “Key Functions” on page 25.
- If necessary, change to the desired stitch width or stitch length. (page 62)

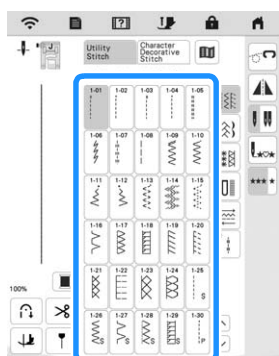

→ The symbol of the correct presser foot will be displayed in the upper left corner of the LCD screen.

4 Install the presser foot (page 50).

⚠ CAUTION

- Always use the correct presser foot. If the wrong presser foot is used, the needle will strike the presser foot and bend or break, possibly resulting in injury. Refer to “STITCH SETTING CHART” on page 194 for presser foot recommendations.

5 Set the fabric under the presser foot. Hold the fabric and thread in your left hand, and rotate the handwheel to set the needle in the sewing start position.

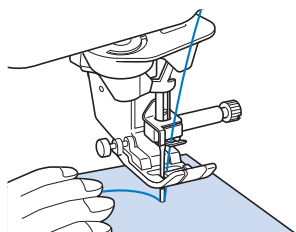

6 Lower the presser foot.

- * You do not have to pull up the bobbin thread.

7 Adjust the sewing speed with the speed control slide.

- * You can use this slide to adjust sewing speed during sewing.

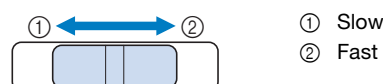

8 Press the “Start/Stop” button to start sewing.

- * Guide the fabric lightly by hand.

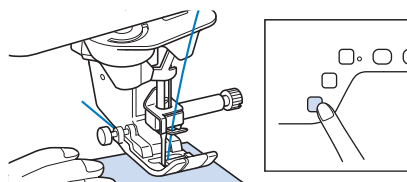

📖 Memo

- When the foot controller is being used, you cannot start sewing by pressing the “Start/Stop” button.

9 Press the “Start/Stop” button again to stop sewing.

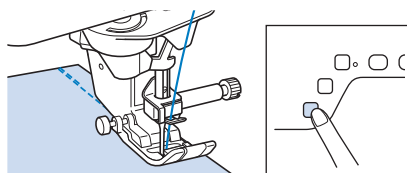

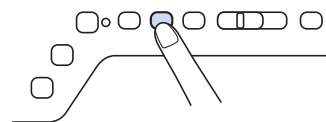

10 Press (Thread cutter button) to trim the upper and bobbin threads.



→ The needle will return to the up position automatically.

⚠ CAUTION

- Do not press  (Thread cutter button) after the threads have been cut. Doing so could tangle the thread or break the needle and damage the machine.
- Do not press  (Thread cutter button) when there is no fabric set in the machine or during machine operation. The thread may tangle, possibly resulting in damage.

Note

- When cutting thread, such as metallic thread or other decorative threads, use the thread cutter on the side of the machine. Cut transparent nylon thread in the same way.

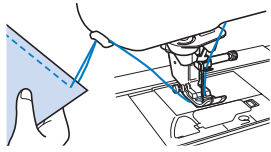

11 When the needle has stopped moving, raise the presser foot and remove the fabric.

Using the Foot Controller

You can also use the foot controller to start and stop sewing.

Memo

- When the foot controller is connected, you cannot use the “Start/Stop” button.
- The foot controller cannot be used when embroidering.

1 Turn off the machine.

2 Insert the foot controller plug into the foot controller jack on the machine.



3 Turn on the machine.

4 Slowly depress the foot controller to start sewing.

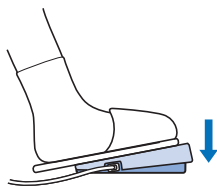

Memo

- The speed that is set using the sewing speed controller will be the foot controller’s maximum sewing speed.

5 Release the foot controller to stop the machine.

Combining Stitch Patterns

Stitch patterns from the following categories can be combined.

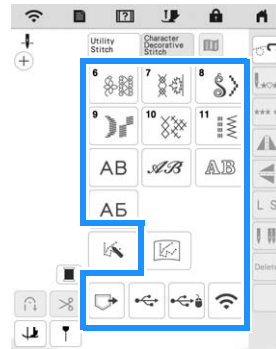

Example:



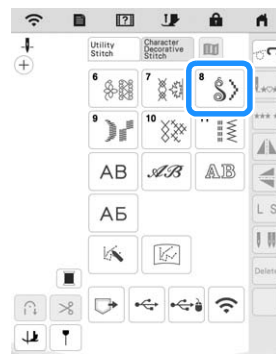

1 Press .

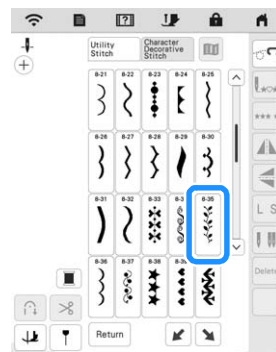

2 Select the following stitch pattern (8-35).



3 Press  so that it displays .

4 Press .

→ The display returns to the stitch selection screen.

5 Select a font.



6 Enter characters.

- : Select a stitch pattern individually.
- : Delete the selected stitch pattern.
- : Enter a space.

7 If you want to sew the stitch pattern continuously,

press .



→ The stitch pattern turns continuous.

Memo

- When sewing is completed, trim any excess thread between characters.

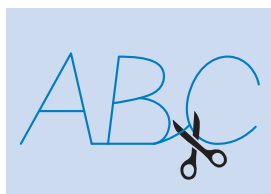

Inserting Stitch Patterns

- 1 Press or to select the stitch pattern at the position where a new stitch pattern will be added.



- 2 Press .

- 3 Select a new stitch pattern.

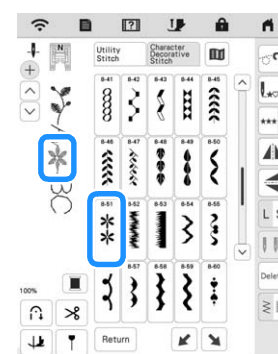

→ The new stitch pattern is added immediately after the stitch pattern selected in step 1.

Sewing Reverse Stitches/Reinforcement Stitches

Reverse/reinforcement stitches are generally necessary at the beginning and end of sewing. You can use (Reverse stitch button) to sew reverse/reinforcement stitches. When you keep pressing (Reinforcement stitch button), the machine will sew reinforcement stitch at that point 3 to 5 stitches, and then stop. (page 13)

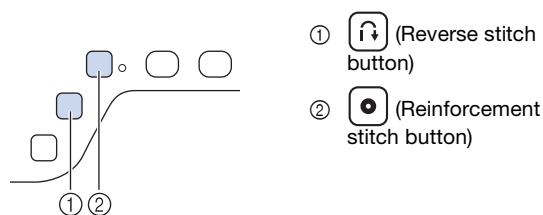

If the automatic reinforcement stitch is selected on the screen, reverse stitches (or reinforcement stitches) will be sewn automatically at the beginning of sewing when the "Start/Stop" button is pressed. Press (Reverse

stitch button) or  (Reinforcement stitch button) to sew reverse stitches (or reinforcement stitches) automatically at the end of sewing (Refer to the next procedure “Automatic Reverse/Reinforcement Stitching”).

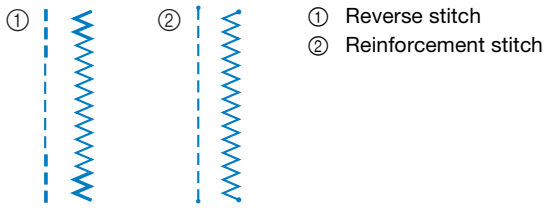

The operation performed when the button is pressed differs depending on the selected stitch pattern. (Refer to “STITCH SETTING CHART” on page 194.)

Automatic Reverse/Reinforcement Stitching

After selecting a stitch motif, turn on the automatic reinforcement stitching function before sewing, and the machine will automatically sew reinforcement stitches (or reverse stitches, depending on the stitch motif) at the beginning and end of sewing.

1 Select a stitch pattern.

2 Press  to set the automatic reinforcement stitching function.

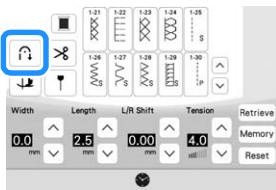

→ The key will display as .



Memo

- Some stitches, such as buttonholes and bar tacks, require reinforcement stitches at the beginning of sewing. If you select one of these stitches, the machine will automatically turn on this function (the key appears as  when the stitch is selected).

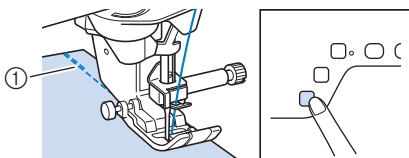
3 Set the fabric in the start position and start sewing.







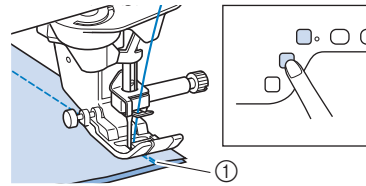











① Reverse stitches (or reinforcement stitches)
→ The machine will automatically sew reverse stitches (or reinforcement stitches) and then continue sewing.











4 Press  (Reverse stitch button) or  (Reinforcement stitch button).

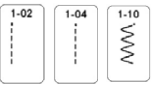

① Reverse stitches (or reinforcement stitches)
→ The machine will sew reverse stitches (or reinforcement stitches) and stop.

The operation performed when the button is pressed differs depending on the selected stitch pattern. Refer to the following table for details on the operation that is performed when the button is pressed.

	 (Reverse stitch button)	 (Reinforcement stitch button)
Utility Stitch +  1-01 1-03 1-09	Machine sews reverse stitches while holding  (Reverse stitch button).	Machine sews 3 – 5 reinforcement stitches while holding  (Reinforcement stitch button).
Utility Stitch +  1-02 1-04 1-10	Machine sews reverse stitches while holding  (Reverse stitch button).*	Machine sews 3 – 5 reinforcement stitches while holding  (Reinforcement stitch button).
 with a stitch other than reverse or reinforcement stitch pattern selected.	Machine sews 3 – 5 reinforcement stitches while holding  (Reverse stitch button).	Machine sews 3 – 5 reinforcement stitches while holding  (Reinforcement stitch button).
Character Decorative Stitch + 	Machine sews reinforcement stitches while holding  (Reverse stitch button).	Machine sews reinforcement stitches after completing the stitch pattern, when  (Reinforcement stitch button) is pressed.
Utility Stitch +  1-01 1-03 1-09	Machine sews reverse stitches and stops sewing when the  (Reverse stitch button) is pressed. (At the beginning of sewing, reverse stitches are sewn automatically when “Start/Stop” button is pressed.)	Machine sews reinforcement stitches and stops sewing when  (Reinforcement stitch button) is pressed. (At the beginning of sewing, reverse stitches are sewn automatically when “Start/Stop” button is pressed.)



	 (Reverse stitch button)	 (Reinforcement stitch button)
Utility Stitch +  	Machine sews reverse stitches and stops sewing when  (Reverse stitch button) is pressed.* (At the beginning of sewing, reinforcement stitches are sewn automatically when "Start/Stop" button is pressed.)	Machine sews reinforcement stitches and stops sewing when  (Reinforcement stitch button) is pressed. (At the beginning of sewing, reinforcement stitches are sewn automatically when "Start/Stop" button is pressed.)
 with a stitch other than reverse or reinforcement stitch pattern selected.	Machine sews reinforcement stitches and stops sewing when  (Reverse stitch button) is pressed. (At the beginning of sewing, reinforcement stitches are sewn automatically when "Start/Stop" button is pressed.)	Machine sews reinforcement stitches and stops sewing when  (Reinforcement stitch button) is pressed. (At the beginning of sewing, reinforcement stitches are sewn automatically when "Start/Stop" button is pressed.)
Character Decorative Stitch + 	Machine sews reinforcement stitches and stops sewing when  (Reverse stitch button) is pressed. (At the beginning of sewing, reinforcement stitches are sewn automatically when "Start/Stop" button is pressed.)	Machine sews reinforcement stitches and stops sewing after completing the stitch pattern, when  (Reinforcement stitch button) is pressed. (At the beginning of sewing, reinforcement stitches are sewn automatically when "Start/Stop" button is pressed.)

* If [Reinforcement Priority] of the settings screen is set to [ON] (page 27), reinforcement stitches are sewn instead of reverse stitches.

Automatic Presser Foot Lowering Function and Thread Cutting Function

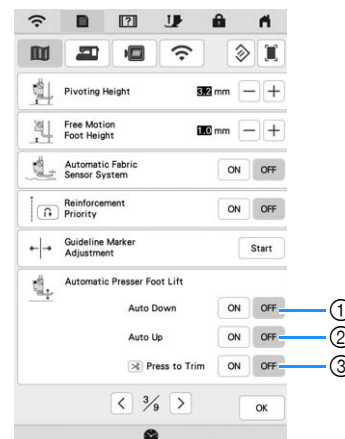
By setting the machine to automatically raise and lower the presser foot, sewing operations can be performed more smoothly.



- ① When [Auto Down] is set to [ON], pressing the "Start/Stop" button or depressing the foot controller automatically lowers the presser foot (if it is raised) before starting to sew.
- ② When [Auto Up] is set to [ON], the presser foot is raised when stopping sewing.
The presser foot is raised to the height specified for [Presser Foot Height] (page 27).
When the pivot setting () is selected, the presser foot is raised to the height specified for [Pivoting Height] (page 27).
- ③ When [Press to Trim] is set to [ON], pressing  (Thread cutter button) automatically lowers the presser foot (if it is raised) before cutting the thread. The presser foot will be raised after the thread is cut.

STITCH SETTINGS

Setting the Stitch Width/Stitch Length/“L/R Shift”

When you select a stitch, your machine automatically selects the appropriate stitch width, stitch length, and L/R Shift. However, if needed, you can change any of the individual settings.

Note

- Settings for some stitches cannot be changed (page 194).
- If you turn off the machine or select another stitch without saving stitch setting changes (page 63), the stitch settings will return to their default settings.

Memo

- Press **Memory** to save the stitch settings.
- Press **Info** to check changes made to the stitch.
- Press **Reset** to return the original setting.

CAUTION

- After adjusting the stitch width or the “L/R Shift”, slowly turn the handwheel toward you (counterclockwise) and check that the needle does not touch the presser foot. If the needle hits the presser foot, the needle may bend or break.
- If the stitches get bunched together, lengthen the stitch length and continue sewing. Do not continue sewing without lengthening the stitch length. Otherwise, the needle may break and cause injury.

Setting the Stitch Width

Follow the steps below when you want to change the zigzag stitch pattern width.

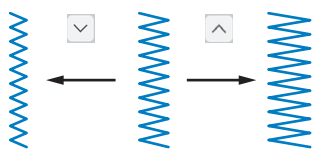

For an alternate method of changing the stitch width using the speed controller, refer to page 79.

Setting the Stitch Length

Follow the steps below when you want to change the stitch pattern length.



Setting the “L/R Shift”

Follow the steps below when you want to change the placement of the zigzag stitch pattern by moving it left and right.

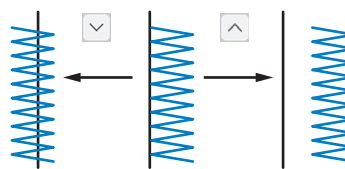

Setting the Thread Tension

You may need to change the thread tension, depending on the fabric and thread being used. Follow the steps below to make any necessary changes.



- * Press **Reset** to return the thread tension to the original setting.

Proper Thread Tension

The upper thread and the bobbin thread should cross near the center of the fabric. Only the upper thread should be visible from the right side of the fabric, and only the bobbin thread should be visible from the wrong side of the fabric.

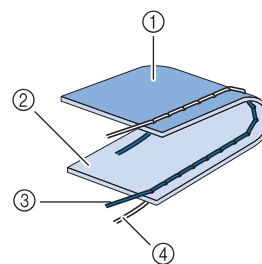

- ① Wrong side
- ② Surface
- ③ Upper thread
- ④ Bobbin thread

Upper Thread is Too Tight

If the bobbin thread is visible from the right side of the fabric, the upper thread is too tight.

Note

- If the bobbin thread was incorrectly threaded, the upper thread may be too tight. In this case, refer to “Setting the Bobbin” on page 40 and rethread the bobbin thread.

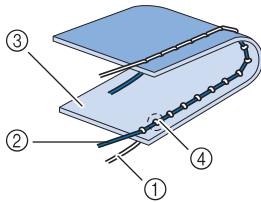

- ① Bobbin thread
- ② Upper thread
- ③ Surface
- ④ Locks appear on surface of fabric

Press , to loosen the upper thread.

Upper Thread is Too Loose

If the upper thread is visible from the wrong side of the fabric, the upper thread is too loose.

Note

- If the upper thread was incorrectly threaded, the upper thread may be too loose. In this case, refer to “Upper Threading” on page 42 and rethread the upper thread.

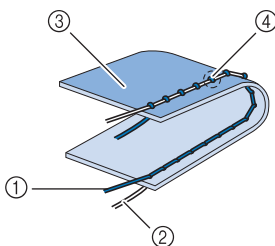

- ① Upper thread
- ② Bobbin thread
- ③ Wrong side
- ④ Locks appear on wrong side of fabric

Press , to tighten the upper thread.

Saving Your Stitch Settings

The settings for the zigzag stitch width, stitch length, thread tension, automatic thread cutting, automatic reinforcement stitching, etc., are preset in the machine for each stitch. However, if you have specific settings that you wish to reuse later for a stitch, you can change the settings so that they can be saved for that stitch. Five sets of settings can be saved for a single stitch.

Saving Settings

- 1 Select a stitch.
- 2 Specify your preferred settings.





- 3 Press .



→ The settings are saved and the original screen automatically appears.

Retrieving Saved Settings

- 1 Select a stitch.
- 2 Press .
- 3 Press the numbered key of the settings to be retrieved.



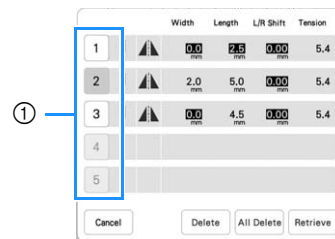

* Press  to return to the original screen without retrieving settings.



① Numbered keys

- 4 Press .
- The selected settings are retrieved, and the original screen automatically appears.

Memo

- To save new settings when there are already 5 sets of settings saved for a stitch, press . Press the numbered key of the setting to be deleted.
- Press , press  and then . The new setting will be saved in place of the recently deleted setting.
- You can delete all the saved settings by pressing .

Returning the Selected Stitch Pattern Saved Settings to the Default Settings

- 1 Press .



- 2 Press .





USEFUL FUNCTIONS

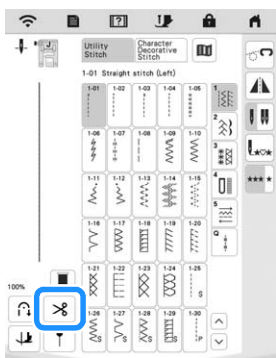

Automatic Thread Cutting

After selecting a stitch pattern, turn on the automatic thread cutting function before sewing, and the machine will automatically sew reinforcement stitches (or reverse stitches, depending on the stitch pattern) at the beginning and end of sewing, and trim the threads at the end of sewing. This function is useful when sewing buttonholes and bar tacks.



- 1 Select a stitch pattern.
- 2 Press  to set the automatic thread cutting function.



→ You get  , and the machine is set for automatic thread cutting function and automatic reverse/reinforcement stitching.

- * To turn off the automatic thread cutting function, press  again, so it appears as .

- 3 Set the fabric in the start position and start sewing.
→ The machine will automatically sew reverse stitches (or reinforcement stitches) and then continue sewing.

- 4 Once you have reached the end of the stitching, press  (Reverse stitch button) or  (Reinforcement stitch button) once.

If stitching, such as buttonholes and bar tacking, that includes reinforcement stitching has been selected, this operation is unnecessary.

→ After the reverse stitching (or reinforcement stitching) has been done, the machine stops, and the threads are cut.

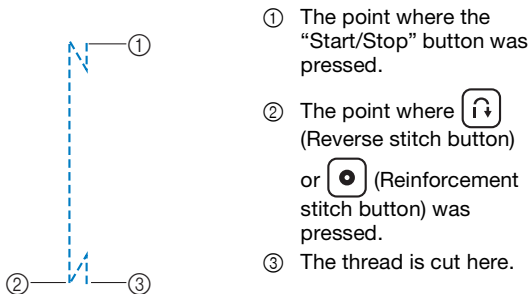

Adjusting the Needle Drop Point with the Guideline Marker

The red guideline marker indicates the sewing position on the fabric. You can adjust the sewing position by moving the guideline marker while checking the guideline marker on the fabric.

CAUTION

- The guideline marker is a laser; therefore, do not stare at the laser light directly. Otherwise it may cause blindness.

- 1 Press  to display the guideline marker.

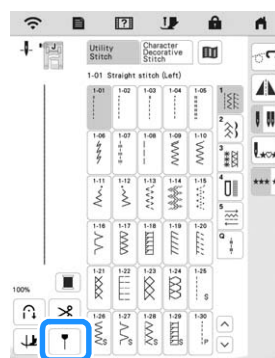

→ The guideline marker scale appears.

- * Depending on the setting of "Initial Position" in the settings screen, the initial needle drop point is scaled as either 0.0 mm or 3.5 mm.

- 2 Use  or  to move the needle drop point.

→ Adjust the position from 15.5 mm (5/8 inch) to the right of the left needle to -3.5 mm (-1/8 inch) to the left of the left needle.





- 1 Press to flip the guideline marker position on the center needle position.



- 3 Press  again to stop using the guideline marker.

■ Adjusting the Guideline Marker Position

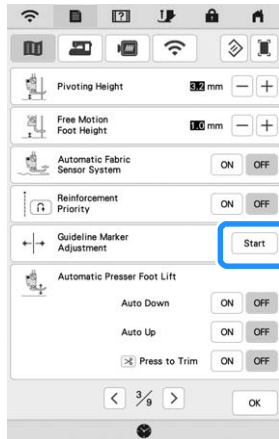

If the guideline marker indicates the position incorrectly in the center needle position, adjust the initial position in the settings screen.

- 1 Press  .
→ The settings screen appears.
- 2 Press  .
→ The sewing settings screen appears.
- 3 Display [Guideline Marker Adjustment] in the sewing settings screen.
- 4 Press  .





- 5 Use  or  to adjust the guideline marker position.





- *  : Move the guideline marker to the left.
 : Move the guideline marker to the right.

- 6 Press  twice to return to the original screen.

■ Adjusting the Brightness of the Guideline Marker

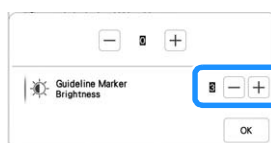
- 1 Follow steps from 1 to 4 to display the [Guideline Marker Adjustment] screen.
- 2 Use  or  to adjust the brightness of the guideline marker.
→ Set the brightness of the guideline marker from [1] for a dim marker, to [5] for the brightest marker, on the fabric.



- 3 Press  twice to return to the original screen.



Pivoting

If the pivot function is selected, the machine stops with the needle lowered (in the fabric) and the presser foot is automatically raised to an appropriate height when the “Start/Stop” button is pressed. When the “Start/Stop” button is pressed again, the presser foot is automatically lowered and sewing continues. This function is useful for stopping the machine to rotate the fabric.

⚠ CAUTION







- When the pivot setting is selected, the machine starts when the “Start/Stop” button is pressed or the foot controller is pressed down even if the presser foot has been raised. Be sure to keep your hands and other items away from the needle, otherwise injuries may occur.

📝 Memo

- When the pivot setting is selected, the height of the presser foot when sewing is stopped can be changed according to the type of fabric being sewn. Press  to display [Pivoting Height] of the settings screen. Press  or  to select the height. To raise the presser foot further, increase the setting.



💡 Note

- The [Needle Position – Up/Down] of the settings screen, must be set in the down position  for the pivot function to be used. When [Needle Position – Up/Down] is set in the raised position ,  appears as light gray and cannot be used.
- The pivot function can only be used with stitches where presser foot “J”, “N” or “X” (Couching foot) is indicated in the upper-left corner of the screen. If any other stitch is selected,  appears as light gray and is not available.
- If the pivot function is selected,  and  beside [Presser Foot Height] in the settings screen are not available and the setting cannot be changed.

- 1 Select a stitch.

2 Press  to select the pivot setting.

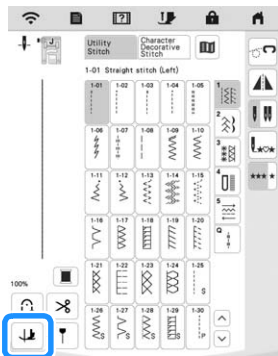

→ The key appears as .

Note

- To use the pivot function, the needle position must be set to .

3 Set the fabric in the start position and start sewing.

4 Press the “Start/Stop” button to stop the machine at the point where the sewing direction changes.

→ The machine stops with the needle in the fabric, and the presser foot is raised.

Memo

- If [Auto Up] of [Automatic Presser Foot Lift] in the machine settings screen is set to [ON], the presser foot is raised when the machine is stopped.

5 Rotate the fabric, and then press the “Start/Stop” button.

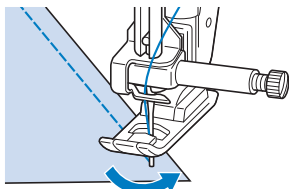

→ The presser foot is automatically lowered, and sewing continues.

Using the Knee Lifter

Using the knee lifter, you can raise and lower the presser foot with your knee, leaving both hands free to handle the fabric.

1 Align the tabs on the knee lifter with the notches in the knee lifter slot on the front of the machine. Insert the knee lifter bar as far as possible.

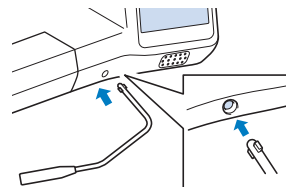

Note

- If the knee lifter bar is not pushed into the mounting slot as far as possible, it may come out during use.

2 Use your knee to move the knee lifter bar to the right in order to raise the presser foot. Slowly return the knee lifter bar to the left to lower the presser foot.

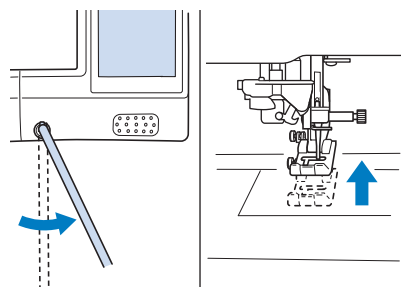

CAUTION

- Be sure to keep your knee away from the knee lifter during sewing. If the knee lifter is pushed during machine operation, the needle may break or the thread tension may loosen.

Memo

- When the presser foot is in the up position, move the knee lifter to the far right and then move the knee lifter to the left to return the presser foot to the down position.



Automatic Fabric Sensor System (Automatic Presser Foot Pressure)

The thickness of the fabric is automatically detected and the presser foot pressure is automatically adjusted with an internal sensor while sewing, to insure that your fabric is fed smoothly. The fabric sensor system works continuously while sewing. This function is useful for sewing heavyweight fabrics (page 69), or quilting (page 78).

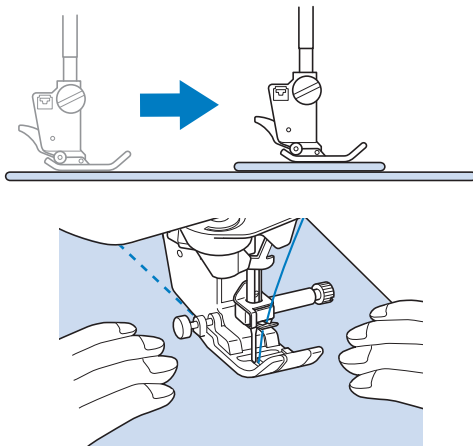
Press , and then set [Automatic Fabric Sensor System] to [ON]. (page 27)





Needle Position - Stitch Placement

When the [Needle Position - Stitch Placement] is set to [ON], the needle will stop immediately before entering the fabric so the needle drop point at the beginning of stitching can be checked. Each press of  (Needle position button) changes the needle to the next position. When the [Needle Position - Stitch Placement] is [OFF], each press of  (Needle position button) simply raises and then lowers the needle.

Press , and then set [Needle Position - Stitch Placement] to [ON] or [OFF]. (page 28)

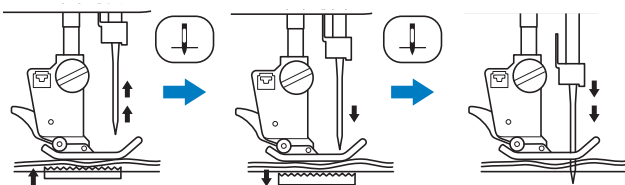
[Needle Position - Stitch Placement] is [ON]



* When the needle is nearly lowered by pressing  (Needle position button), the feed dogs are lowered. At this time, the fabric can be shifted to finely adjust the needle drop point.

[Needle Position - Stitch Placement] is [OFF]

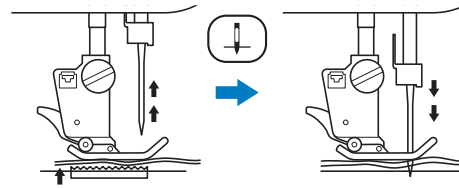

Using the Straight Stitch Needle Plate and the Straight Stitch Foot

The straight stitch needle plate and the straight stitch foot can only be used for straight stitches (middle needle position stitches). Use the straight stitch needle plate and the straight stitch foot when sewing thin fabrics or when sewing small pieces which tend to sink into the hole of the regular needle plate during sewing. The straight stitch foot is perfect to reduce puckering on lightweight fabrics. The small opening on the foot provides support for the fabric as the needle travels through the fabric.

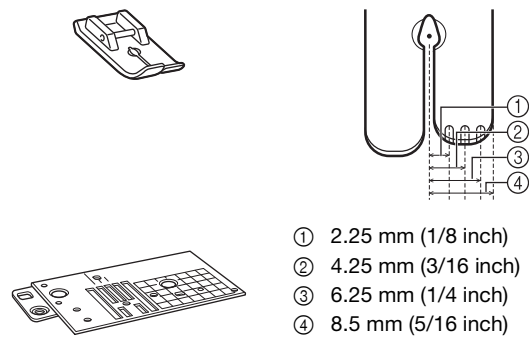

CAUTION

- Always use the straight stitch foot in combination with the straight stitch needle plate.

- Press  (Needle position button) to raise the needle and turn the main power to OFF.
- Remove the needle and the presser foot holder. (page 48, page 50)
- Remove the bobbin case and the needle plate. (page 176, page 177)

- 4 Align the two screw holes in the straight stitch needle plate with the two holes in the needle plate mounting base, and then fit the straight stitch needle plate onto the machine.
- 5 Lightly finger-tighten the screw on the right side of the needle plate. Then, use the included disc-shaped screwdriver to firmly tighten the screw on the left side. Finally, firmly tighten the screw on the right side.

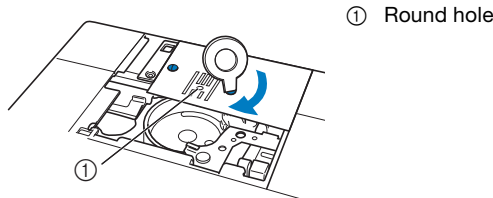

- 6 Insert the bobbin case in its original position, and then attach the needle plate cover. (page 176)
- 7 After reinstalling the needle plate cover, select any of the straight stitches.

Note

- If the needle plate has been removed, check machine operations to confirm that installation has been completed correctly. (page 181)
- Selecting unavailable stitches will cause an error message to be displayed.
- When the straight stitch needle plate is on the machine, the needle will automatically move to the middle position.

Memo

- You cannot change the needle position using the L/R Shift.
- Always secure the needle plate before inserting the bobbin case into its original position.

CAUTION

- Slowly rotate the handwheel toward you (counterclockwise) before sewing and make sure that the needle is not contacting the straight stitch foot and straight stitch needle plate.

- 8 Insert needle and attach the straight stitch foot.

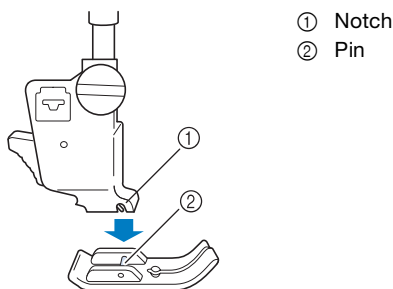

- 9 Turn the main power to ON and then start sewing.

* After sewing, make sure to remove the straight stitch needle plate and the straight stitch foot, and reinstall the regular needle plate, the needle plate cover and the presser foot "J".

USEFUL SEWING TIPS

Sewing Tips

■ Trial Sewing

Before starting your sewing project, we recommend sewing trial stitches using thread and scrap fabric that are the same as those used for your project.

While checking the sewing results, adjust the thread tension as well as the stitch length and width according to the number of fabric layers and stitch that is sewn.

💡 Note

- Other factors, such as fabric thickness, stabilizer material, etc., also have an effect on the stitch, so you should always sew a few trial stitches before beginning your project.
- When sewing decorative satin stitch or satin stitch patterns, there may be shrinking or bunching of stitches, so be sure to use a stabilizer material.

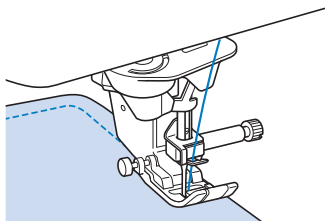

■ Sewing Curves

Sew slowly while keeping the seam parallel with the fabric edge as you guide the fabric around the curve.



Shorten the stitch length setting to obtain a fine stitch. Sew slowly, keeping the seams parallel with the fabric edge as you guide the fabric around the curve.

■ Changing Sewing Direction

Stop the machine. Leave the needle in the fabric, and press  (Presser foot lifter button) to raise the presser foot. Using the needle as a pivot, turn the fabric so that you can sew in the new direction. Press  (Presser foot lifter button) to lower the presser foot and start sewing.

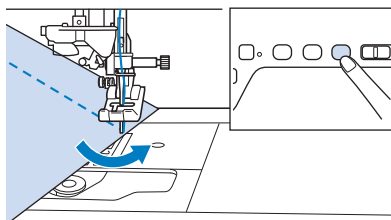

The pivot setting is useful when changing the sewing direction. (page 65)

Sewing Various Fabrics

■ Sewing Heavyweight Fabrics

The machine can sew fabrics up to 6 mm (approx. 1/4 inch) thick. If the thickness of a seam causes sewing to occur at an angle, help guide the fabric by hand and sew on the downward slope.

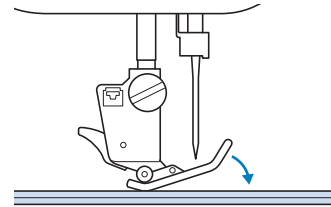

⚠ CAUTION

- Do not forcefully push fabrics more than 6 mm (approx. 1/4 inch) thick through the machine. This may cause the needle to break and cause injury.

- If the Fabric does not Fit under the Presser Foot
If the presser foot is in the up position, and you are sewing heavyweight or multiple layers of fabric which do not fit easily under the presser foot, use the presser foot lever to raise the presser foot to its highest position. The fabric will now fit under the presser foot.

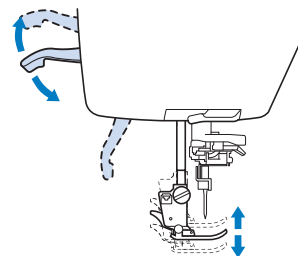

- If the Fabric does not Feed
If the fabric does not feed when starting to sew or when sewing thick seams, press the presser foot locking pin on the left side of presser foot "J".

- 1 Raise the presser foot.
- 2 While keeping the presser foot locking pin on the left side of presser foot "J" pressed in, press  (Presser foot lifter button) to lower the presser foot.

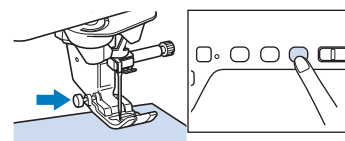

3 Release the presser foot locking pin.

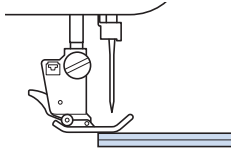

→ The presser foot remains level, enabling the fabric to be fed.

Memo

- Once the trouble spot has been passed, the foot will return to its normal position.

■ Sewing Lightweight Fabrics

Place thin paper or tear away embroidery stabilizer under thin fabrics to make sewing easier. Gently tear off the paper or the stabilizer after sewing.

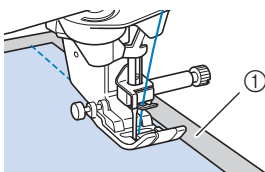

① Thin paper

■ Sewing Stretch Fabrics

First, baste together the pieces of fabric, and then sew without stretching the fabric. In addition, a better result can be achieved by using thread for knits or a stretch stitch.

Memo

- For best results when sewing stretch fabrics, decrease the pressure of the presser foot (page 27).

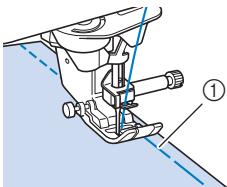

① Basting stitching

■ Sewing Leathers or Vinyl Fabrics

When sewing fabrics that may stick to the presser foot, such as leather or vinyl fabrics, replace the presser foot with the walking foot*, non stick foot* or roller foot*.

* Items sold separately, please contact your authorized Brother dealer.

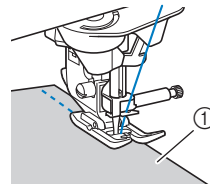

① Leather

If the leather or vinyl fabric sticks to the flat bed attachment, sew with copy paper or tracing paper placed on top of the flat bed attachment so the fabric moves smoothly.

If the paper is positioned so that it does not cover the needle plate, the paper will not be sewn together with the fabric.

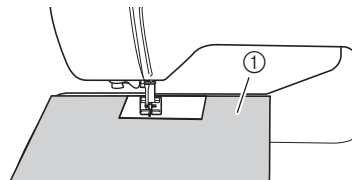

① Copy paper or tracing paper

Sewing Decorative Stitch Patterns

Fabric	When sewing on stretch fabrics, lightweight fabrics, or fabrics with coarse weaves, attach stabilizer on the wrong side of the fabric. An alternative would be to place the fabric on thin paper such as tracing paper.
	<p>① Fabric ② Stabilizer ③ Thin paper</p>
Thread	#50 - #60
Needle	With lightweight, regular, or stretch fabrics: the Ball point needle (golden colored) 90/14 With heavyweight fabrics: home sewing machine needle 90/14



Chapter **3**
Various Stitches

UTILITY STITCHES

CAUTION

- Before replacing the presser foot, be sure to press  to lock all keys and buttons, otherwise injuries may occur if the "Start/Stop" button or any other button is pressed and the machine starts. For details on changing the presser foot, refer to "Replacing the Presser Foot" on page 50.

Straight Stitches

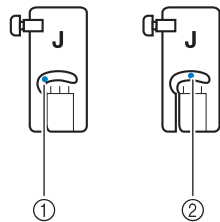
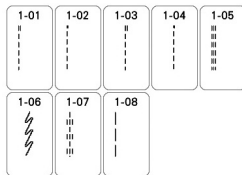

Memo

- For details on stitch patterns, refer to "STITCH SETTING CHART" on page 194.



- ① Left needle position
- ② Middle needle position

Changing the Needle Position (Left or Middle Needle Position Stitches Only)

When you select left or middle needle position stitches, you can use  and  in the L/R Shift display to change the position of the needle. Match the distance from the right edge of the presser foot to the needle with the stitch width, then align the edge of the presser foot with the edge of the fabric during sewing for an attractive finish.

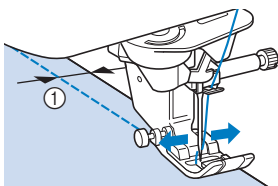

- ① Stitch width

Example: Left/Middle needle position stitches

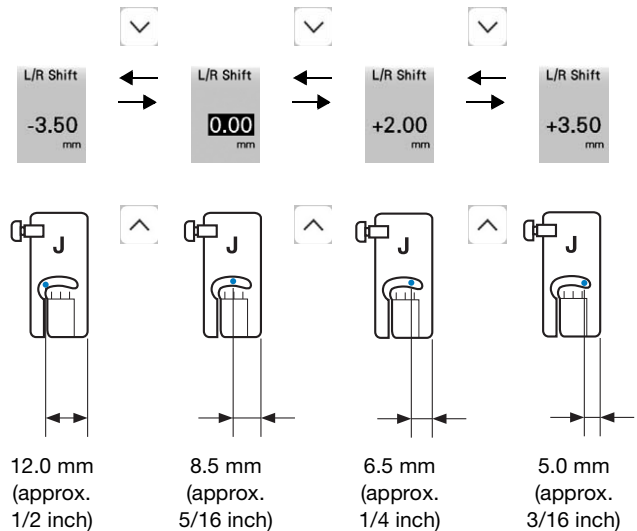

Aligning the Fabric with a Mark on the Needle Plate or Bobbin Cover (with Mark)

While sewing, align the edge of the fabric with the 5/8 inch (approx. 1.6 cm) mark on the needle plate or bobbin cover (with mark) depending on the needle position (left or middle (center) needle position stitches only).

For stitches with a left needle position (Stitch width: 0.0 mm)

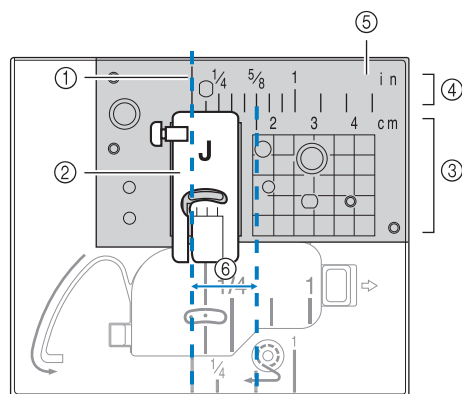

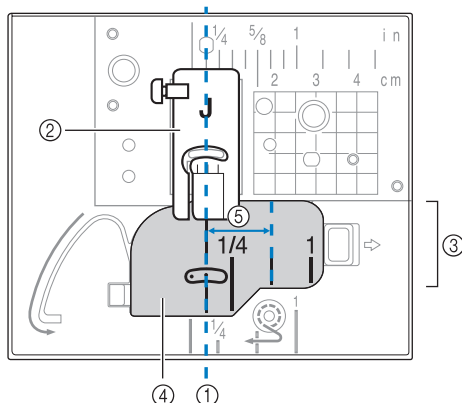

- ① Seam
- ② Presser foot
- ③ Centimeters
- ④ Inches
- ⑤ Needle plate
- ⑥ 5/8 inch (approx. 1.6 cm)

For stitches with a middle (center) needle position
(Stitch width: 3.5 mm)



- ① Seam
- ② Presser foot
- ③ Inches
- ④ Bobbin cover (with mark)
- ⑤ 5/8 inch (approx. 1.6 cm)

■ Basting

- 1 Select  and attach presser foot “J”.
- 2 Keep pressing  (Reverse stitch button) or  (Reinforcement stitch button) to sew 4 stitches of reinforcement stitches, then press “Start/Stop” button to continue sewing.

Memo

- Before sewing, pull up the bobbin thread, align it with the upper thread, and then pull them to the back of the machine. (page 41) For clean stitching, hold these thread ends when starting to sew.
- You can set the stitch length between 5 mm (approx. 3/16 inch) and 30 mm (approx. 1-3/16 inches).

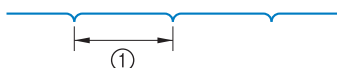

- ① Between 5 mm (approx. 3/16 inch) and 30 mm (approx. 1-3/16 inches)

- 3 When sewing is finished, sew reinforcement stitches, and then cut the threads to a generous length.

■ Dart Seam

- 1 Select  and attach presser foot “J”.
- 2 Sew a reverse stitch at the beginning of the dart and then sew from the wide end to the other end without stretching the fabric.

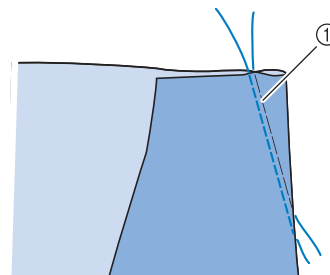

- ① Basting

- 3 Cut the thread at the end leaving 5 cm (approx. 2 inches), and then tie both ends together.

* Do not sew a reverse stitch at the end.

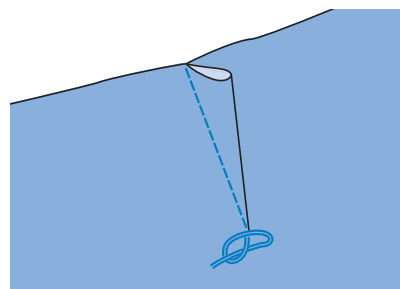

- 4 Insert the ends of the thread into the dart with a hand sewing needle.

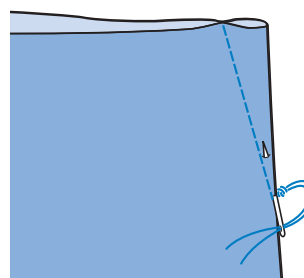

- 5 Iron the dart to one side so that it is flat.

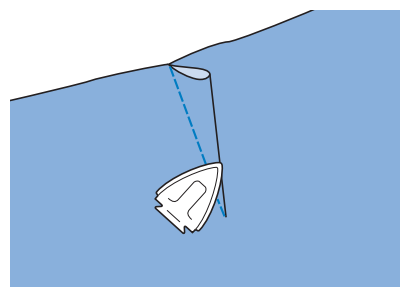

■ Gathering

Use on waists of skirts, sleeves of shirts, etc.

- 1 Select a straight stitch and attach presser foot "J".

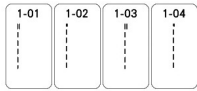

- 2 Set the stitch length to 4.0 mm (approx. 3/16 inch) and the thread tension to approximately 2.0 (weaker tension).

- 3 Pull the bobbin and upper threads out by about 10 cm (4 inches) (page 41).

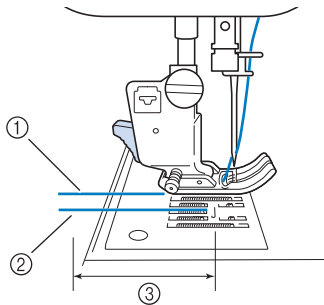

- ① Upper thread
- ② Bobbin thread
- ③ About 10 cm (4 inches)

- 4 Sew two rows of straight stitches parallel to the seam line, then trim excess thread leaving about 5 cm (2 inches).

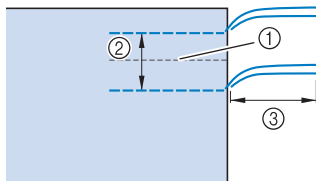

- ① Seam line
- ② 1 cm to 1.5 cm (approx. 3/8 inch to 9/16 inch)
- ③ About 5 cm (2 inches)

- 5 Pull the bobbin threads to obtain the desired amount of gather, then tie the threads.

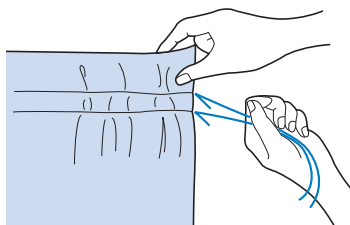

- 6 Smooth the gathers by ironing them.

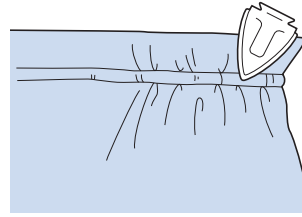

- 7 Sew on the seam line and remove the basting stitch.

■ Flat Fell Seam

Use for reinforcing seams and finishing edges neatly.

- 1 Select  and attach presser foot "J".

- 2 Sew the finish line, then cut half of the seam allowance from the side on which the flat fell seam will lie.

* When the automatic thread cutting and automatic reinforcement stitching are preset, reverse stitches will be sewn automatically at the beginning of sewing. Press  (Reinforcement stitch button) to sew a reinforcement stitch and trim the thread automatically at the end of sewing.

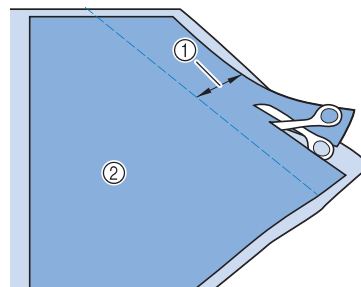

- ① About 1.2 cm (1/2 inch)
- ② Wrong side

- 3 Spread the fabric out along the finish line.

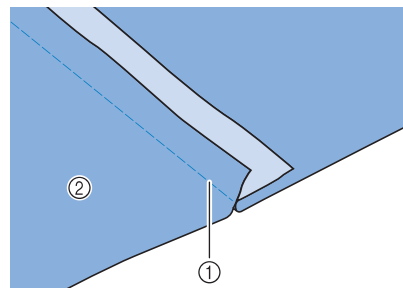

- ① Finish line
- ② Wrong side

- 4** Lay both seam allowances on the side of the shorter seam (cut seam) and iron them.

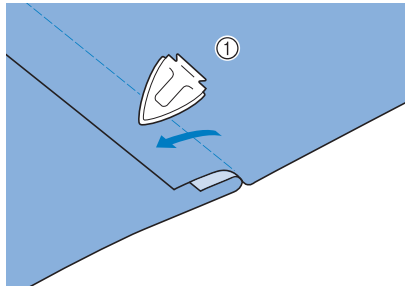

① Wrong side

- 5** Fold the longer seam allowance around the shorter one, and sew the edge of the fold.

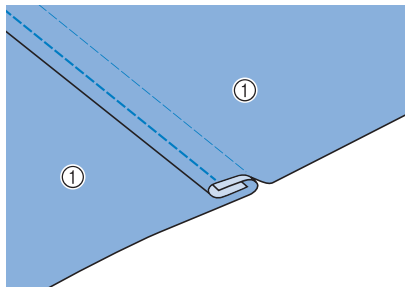

① Wrong side
Finished flat fell seam

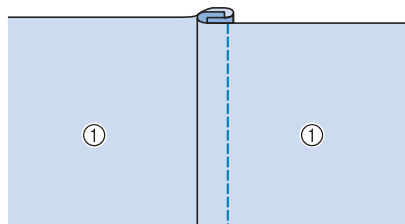

① Surface

■ **Pintuck**

- 1** Mark along the folds on the wrong side of the fabric.

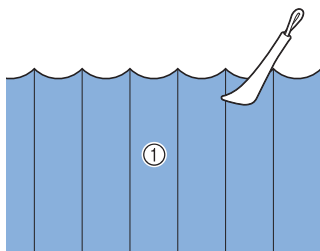

① Wrong side

- 2** Turn the fabric and iron the folded parts only.

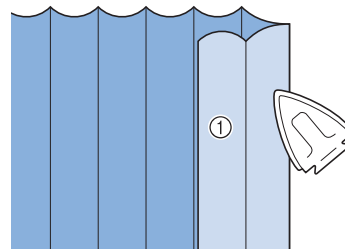

① Surface

- 3** Select  and attach presser foot "J".

- 4** Sew a straight stitch along the fold.

* When the automatic thread cutting and automatic reinforcement stitching are preset, reverse stitches will be sewn automatically at the beginning of sewing. Press  (Reinforcement stitch button) to sew a reinforcement stitch and trim the thread automatically at the end of sewing.

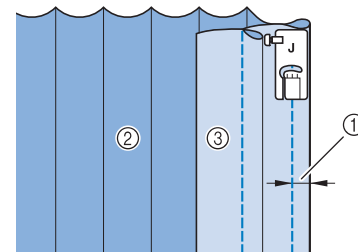

① Width for pintuck
② Wrong side
③ Surface

- 5** Iron the folds in the same direction.

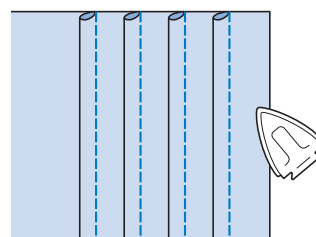

Zigzag Stitches

■ Cord Guide Bobbin Cover (Using a Zigzag Stitch)

- 1 Remove the bobbin cover from the machine (page 40).
- 2 Thread the gimp thread through the hole in the cord guide bobbin cover from top to bottom. Position the thread in the notch at the back of the cord guide bobbin cover.

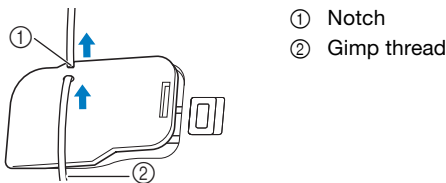

- 3 Snap the cord guide bobbin cover into place, making sure that the gimp thread can be fed freely.
 - * Make sure there are no restrictions when feeding the thread.

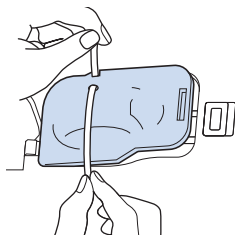

- 4 Set the zigzag width from 2.0-2.5 mm (approx. 1/16 - 3/32 inch).
- 5 Attach presser foot "N".
- 6 Position the fabric right side up on top of the cord and place the cord to the rear of the machine under the presser foot.

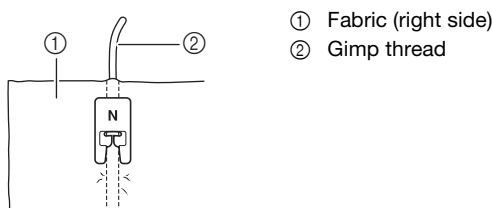

- 7 Lower the presser foot and start sewing to make a decorative finish.

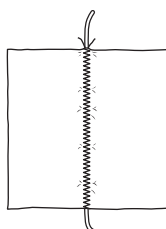

Overcasting

Sew overcasting stitches along the edges of cut fabric to prevent them from fraying.

Memo

- For details on stitch patterns, refer to "STITCH SETTING CHART" on page 194.

■ Using Overcasting Foot "G"

- 1 Select a stitch.



- 2 Attach overcasting foot "G".

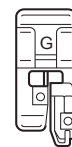

CAUTION

- When using overcasting foot "G", be sure select a stitch that can be used with overcasting foot "G". If you sew with the incorrect stitch, the needle may hit the presser foot, bending the needle or damaging the presser foot.

- 3 Position the fabric with the edge of the fabric against the guide of the presser foot, and then lower the presser foot lever.

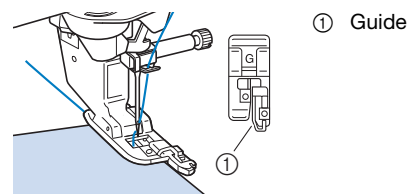

- 4 Rotate the handwheel toward you (counterclockwise). Check that the needle does not touch the presser foot.

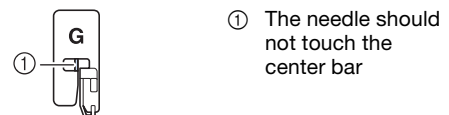

- 5 Sew with the edge of the fabric against the presser foot guide.

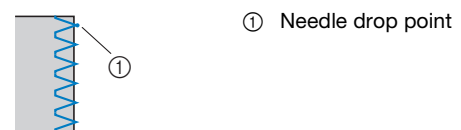

CAUTION

- Be sure to pull the fabric backward after finished sewing. If you pull the fabric toward side or forward, the presser foot pin may be damaged.
- If thread is tangled on the presser foot, remove the entangled thread, and then raise the presser foot lever to remove the presser foot. If the presser foot is raised while entangled with thread, the presser foot may be damaged.

6 Press the "Start/Stop" button to stop sewing when you are finished, and raise the presser foot and needle to pull the fabric under the presser foot towards the back of the machine.

Using Zigzag Foot "J"

1 Select a stitch.



2 Attach zigzag foot "J".

3 Sew along the edge of the fabric with the needle dropping off the edge at the right.

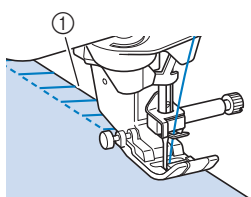

① Needle drop point

Note

- Fine adjustment of the stitching on the fabric can be done with "L/R Shift". Before sewing your project, be sure to sew trial stitches using the same conditions as in the actual project.

Quilting

You can make beautiful quilts quickly and easily with this machine. When making a quilt, you will find it convenient to use the knee lifter and foot controller to free your hands for other tasks ("Using the Foot Controller" on page 58 and /or "Using the Knee Lifter" on page 66).

The 30 quilting stitches Q-01 through Q-30 and the utility stitches with "P" or "Q" indicated on their key are useful for quilting.

The "P" or "Q" at the bottom of the key display indicates that these stitches are intended for ("Q") quilting and ("P") piecing.

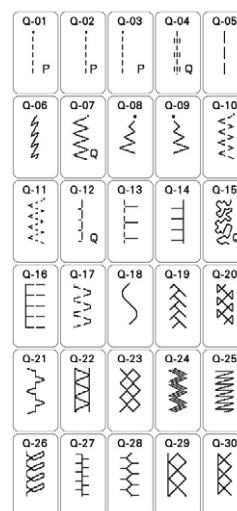

Memo

- When a stitch pattern in the Quilting Stitches category (only quilting stitches marked with "Q") is selected, a finer stitch width can be set than that available with stitch patterns in other categories.
- For details on stitch patterns, refer to "STITCH SETTING CHART" on page 194.

Piecing

Sewing two pieces of fabric together is called piecing. When cutting pieces for quilt blocks, make sure the seam allowance is 6.5 mm (approx. 1/4 inch).

1 Select a stitch and attach presser foot "J".



2 Align the edge of the fabric with the edge of the presser foot, and start sewing.

- * To sew a 6.5 mm (approx. 1/4 inch) seam allowance along the left edge of the presser foot

with  (Q-02) selected, the width (which is the

needle position) should be set to 5.50 mm (approx. 7/32 inch).

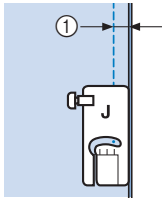

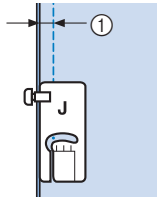

① 6.5 mm (approx. 1/4 inch)

* To sew a 6.5 mm (approx. 1/4 inch) seam allowance along the left edge of the presser foot with  selected, the width should be set to 1.50 mm (approx. 1/16 inch).



① 6.5 mm (approx. 1/4 inch)

* To change the needle position, use  or  in the L/R Shift display.



Memo

- In the case Q-01(center, at L/R Shift 3.5 mm) is selected, if the guideline marker is set at 10.0 mm (3.5 mm plus 6.5 mm, close to 1/4 inch), you can sew piecing by referring to the guideline marker.

■ Piecing Using the 1/4 Quilting Foot with Guide

This quilting foot can sew an accurate 1/4 inch or 1/8 inch seam allowance. It can be used for piecing together a quilt or for topstitching.

1 Press , and then attach the 1/4 quilting foot with guide.

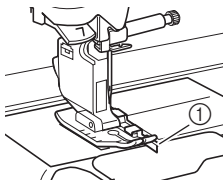

① Guide

2 Use the guide and marks on the presser foot to sew accurate seam allowances.

Piecing a 1/4 inch seam allowance

Sew keeping the edge of the fabrics against the guide.

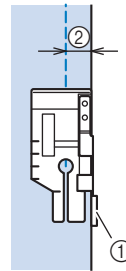

① Guide
② 1/4 inch

Memo

- For accurate fabric placement, refer to “Aligning the Fabric with a Mark on the Needle Plate or Bobbin Cover (with Mark)” on page 72.

Creating an accurate seam allowance

Use the mark on the foot to begin, end, or pivot 1/4 inch from edge of fabric.

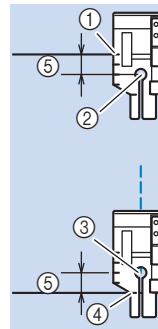

① Align this mark with edge of fabric to begin.
② Beginning of stitching
③ End of stitching
④ Opposite edge of fabric to end or pivot
⑤ 1/4 inch

Memo

- For details on pivoting, refer to “Pivoting” on page 65.

Topstitching quilting, 1/8 inch

Sew with the edge of the fabric aligned with the left side of the presser foot's front section.

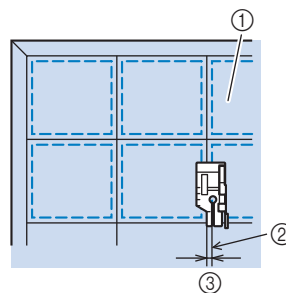

① Surface of fabric
② Seam
③ 1/8 inch

■ Quilting

Sewing the quilt top, batting, and backing together is called quilting. You can sew the quilt with the dual feed foot to keep the quilt top, batting, and backing from sliding. The dual feed foot has a motorized belt that moves together with the feed dogs in the needle plate during sewing.

For straight line quilting, use the dual feed foot and the straight stitch needle plate.

1 Select a stitch.



2 Attach the dual feed foot (page 51).

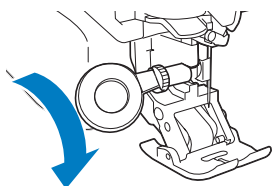

3 Place one hand on each side of the presser foot to hold the fabric secure while sewing.

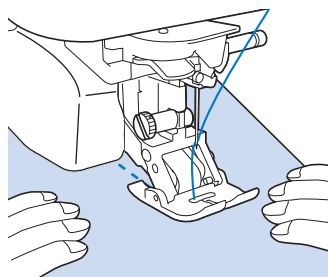

Memo

- Sew at slow to medium speed.
- Always check to be sure that your quilting project is securely basted before beginning to sew.

■ Appliqué

1 Use two-sided stabilizer material to secure the appliqué piece to the base fabric.

2 Select .

3 Attach the zigzag foot “J”.

4 Turn the handwheel toward you (counterclockwise), and then begin sewing around the edge of the appliqué, making sure that the needle drops just outside of the appliqué.

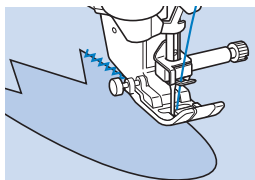

When sewing around corners, stop the machine with the needle in the fabric just outside of the appliqué, raise the presser foot lever, and then turn the fabric as needed to change the sewing direction.

■ Quilting with Satin Stitches

For better fabric control, use the foot controller to sew with satin stitches. Set the speed control slide to control the stitch width to make subtle changes in the stitch width during sewing.

1 Attach the foot controller (page 58).

2 Select and attach presser foot “J”.

3 Press in the length display to shorten the stitch length.



Memo

- The setting will vary according to the kind of fabric and the thickness of the thread, but a length of 0.3 to 0.5 mm (approx. 1/64 to 1/32 inch) is best for satin stitches.

4 Press to use the speed control slide to control the stitch width.

5 Set the [Width Control] to [ON].



6 Press .

→ The display will return to the original screen.

7 While sewing, slide the sewing speed controller to adjust the stitch width.

* Adjust the sewing speed with the foot controller.

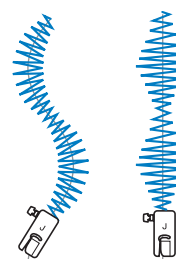
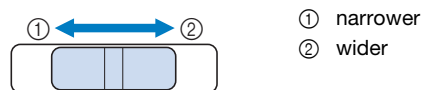



8 When you are finished sewing, set the [Width Control] back to [OFF].

Free Motion Quilting

With free motion quilting, the feed dogs can be lowered by pressing , so that the fabric can be moved freely in any direction.

For free motion quilting, use free motion quilting foot “C” or free motion open toe quilting foot “O” depending on the stitch that is selected, and set the machine to free motion sewing mode. In this mode, the presser foot is raised to the necessary height for free motion sewing. We recommend attaching the foot controller and sewing at a consistent speed. You can adjust the sewing speed with the speed control slide on the machine.

Memo

- With free motion quilting, control the feeding speed of the fabric to match the sewing speed. If the fabric is moved faster than the sewing speed, the needle may break or other damage may result.
- When starting to sew, the internal sensor detects the thickness of the fabric, and the quilting foot is raised to the height specified in the machine settings screen. Press  to display [Free Motion Foot Height] of the settings screen. Press  or  to select the height that the quilting foot is raised above the fabric.



- When stitch Q-01 or 1-31 is selected, free motion quilting foot “C” is indicated in the upper-left corner of the screen. When the other stitches are selected, free motion open toe quilting foot “O” is indicated in the screen.

Using free motion quilting foot “C” (Included with some models)

Use the free motion quilting foot “C” with straight stitch needle plate for free motion sewing.

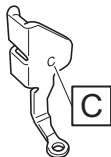

Free motion quilting foot “C”

CAUTION

- When using free motion quilting foot “C”, be sure to use the straight stitch needle plate. If the needle is moved to any position other than the middle (center) needle position, the needle may break, which may result in injuries.

1 Attach the straight stitch needle plate (page 67).

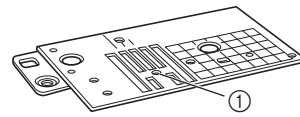

① Round hole

2 Select a stitch.



3 Press to set the machine to free motion sewing mode.



→ The key appears as , the quilting foot is raised to the necessary height, and then the feed dogs are lowered for free motion sewing.

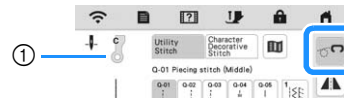

① Free motion quilting foot “C”

4 Remove the presser foot holder (page 50).

5 Attach free motion quilting foot “C” at the front with the presser foot holder screw aligned with the notch in the quilting foot.

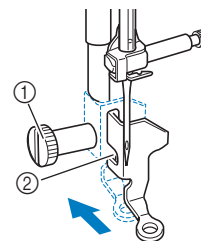

- ① Presser foot holder screw
- ② Notch

Note

- Make sure that the quilting foot is attached properly and not slanted.

6 Hold the quilting foot in place with your right hand, and tighten the presser foot holder screw using the disc-shaped screwdriver with your left hand.

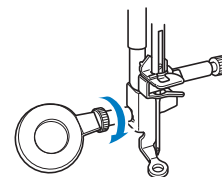

⚠ CAUTION

- Be sure to securely tighten the screws with the disc-shaped screwdriver. Otherwise, the needle may touch the quilting foot, causing it to bend or break.

- 7 Use both hands to stretch the fabric taut, and then move the fabric at a consistent pace in order to sew uniform stitches roughly 2.0-2.5 mm (approx. 1/16 - 3/32 inch) in length.

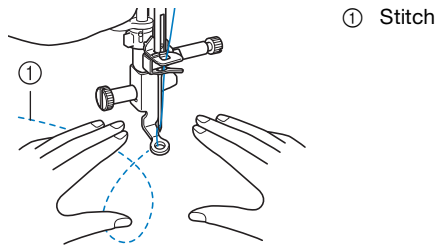

- 8 Press  to cancel the free motion sewing mode.

→ Rotate the handwheel toward you (counterclockwise) to raise the feed dogs.

- 9 After sewing, make sure to remove the straight stitch needle plate and presser foot "C", and reinstall the regular needle plate and the needle plate cover.

💡 Note

- Free motion open toe quilting foot "O" can also be used with the straight stitch needle plate. We recommend using free motion open toe quilting foot "O" with free motion sewing of fabrics of uneven thicknesses.

- Using free motion open toe quilting foot "O"

The free motion open toe quilting foot "O" is used for free motion quilting with zigzag or decorative stitches or for free motion quilting of straight lines on fabric with an uneven thickness. Various stitches can be sewn using free motion open toe quilting foot "O". For details on the stitches that can be used, refer to "STITCH SETTING CHART" on page 194.

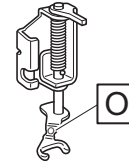

Free motion open toe quilting foot "O"

- 1 Press  to set the machine to free motion sewing mode.

→ The key appears as , the quilting foot is raised to the necessary height, and then the feed dogs are lowered for free motion sewing.

- 2 Select a stitch.

- 3 Remove the presser foot holder (page 50).

- 4 Attach free motion open toe quilting foot "O" by positioning the pin of the quilting foot above the needle clamp screw and aligning the lower-left of the quilting foot and the presser bar.

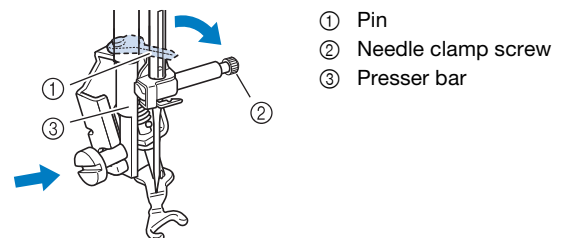

💡 Note

- Make sure that the quilting foot is not slanted.

- 5 Hold the quilting foot in place with your right hand, and tighten the presser foot holder screw using the disc-shaped screwdriver with your left hand.

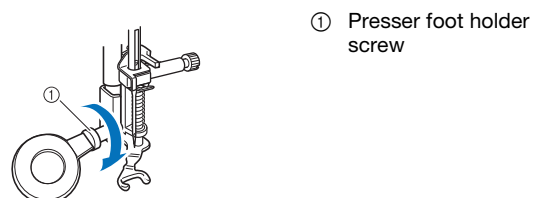

⚠ CAUTION

- Be sure to securely tighten the screws with the disc-shaped screwdriver. Otherwise, the needle may touch the quilting foot, causing it to bend or break.

- 6 Use both hands to stretch the fabric taut, and then move the fabric at a consistent pace in order to sew uniform stitches roughly 2.0-2.5 mm (approx. 1/16 - 3/32 inch) in length.

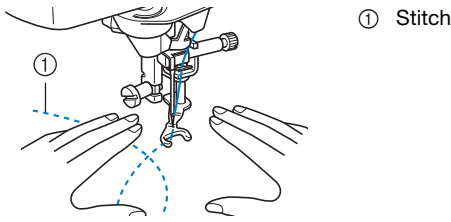

- 7 Press to cancel the free motion sewing mode.
→ Rotate the handwheel toward you (counterclockwise) to raise the feed dogs.

Echo Quilting Using the Free Motion Echo Quilting Foot “E” (Included with Some Models)

Sewing quilting lines at equal distances around a motif is called echo quilting. The quilting lines, which appear as ripples echoing away from the motif, are the distinguishing characteristic of this quilting style. Use the free motion echo quilting foot “E” for echo quilting. Using the measurement on the presser foot as a guide, sew around the motif at a fixed interval. We recommend attaching the foot controller and sewing at a consistent speed.

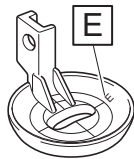

Free motion echo quilting foot “E” measurements

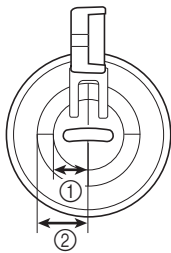

- ① 6.4 mm (approx. 1/4 inch)
- ② 9.5 mm (approx. 3/8 inch)

- 1 Select .
- 2 Press to set the machine to free motion sewing mode.

→ The key appears as , the quilting foot is raised to the necessary height, then the feed dogs are lowered for free motion sewing.

- 3 Remove the presser foot holder and then attach the adapter. (page 50)

- 4 Position the free motion echo quilting foot “E” on the left side of the presser bar with the holes in the quilting foot and presser bar aligned.

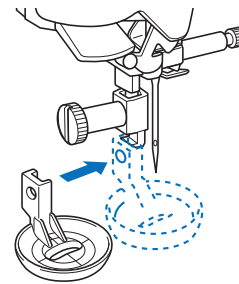

- 5 Tighten the screw with the included screwdriver (large).

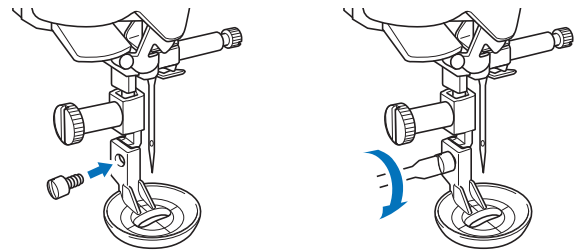

⚠ CAUTION

- Be sure to securely tighten the screws with the included screwdriver (large). Otherwise, the needle may touch the quilting foot, causing it to bend or break.

- 6 Using the measurement on the quilting foot as a guide, sew echo quilting around the motif.

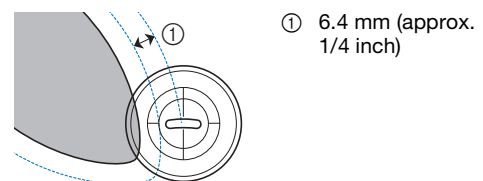
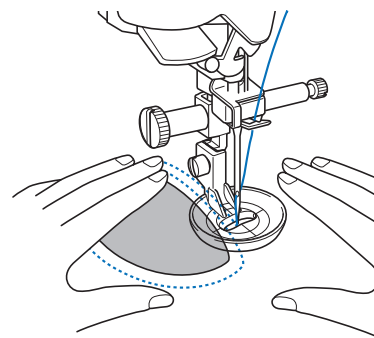

Finished project

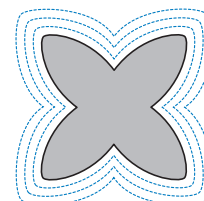

7 Press  to cancel the free motion sewing mode.

→ Rotate the handwheel toward you (counterclockwise) to raise the feed dogs.

Blind Hem Stitches

Secure the lower edge of skirts and pants with a blind hem.

 **Memo**

- When the size of cylindrical pieces is too small to slide onto the arm or the length is too short, the fabric will not feed and desired results may not be achieved.
- For details on stitch patterns, refer to “STITCH SETTING CHART” on page 194.

1 Turn the skirt or pants inside out.

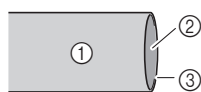

- ① Wrong side of fabric
- ② Right side of fabric
- ③ Lower edge of fabric

2 Fold the lower edge of fabric to the desired length to be hemmed and then press.

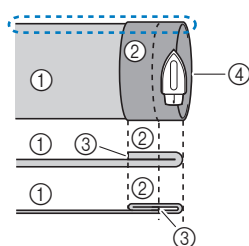

- ① Wrong side of fabric
- ② Right side of fabric
- ③ Lower edge of fabric
- ④ Desired length for hem

<Thick fabric>

<Normal fabric>

<Seen from the side>

3 Using tailor's chalk, mark the fabric about 5 mm (3/16 inch) from the edge of the fabric, and then baste it.

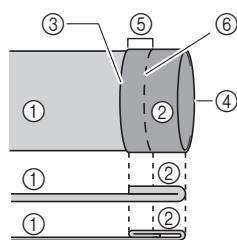

- ① Wrong side of fabric
- ② Right side of fabric
- ③ Lower edge of fabric
- ④ Desired length for hem
- ⑤ 5 mm (3/16 inch)
- ⑥ Basting

<Thick fabric>

<Normal fabric>

<Seen from the side>

4 Fold in the fabric (to the right side) along the basting.

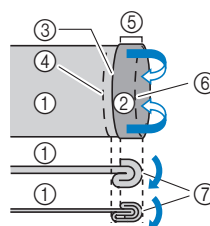

- ① Wrong side of fabric
- ② Right side of fabric
- ③ Lower edge of fabric
- ④ Desired length for hem
- ⑤ 5 mm (3/16 inch)
- ⑥ Basting
- ⑦ Basting point

<Thick fabric>

<Normal fabric>

<Seen from the side>

5 Unfold the edge of fabric, and position the fabric with the wrong side facing up.

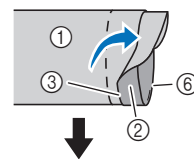

- ① Wrong side of fabric
- ② Right side of fabric
- ③ Edge of fabric
- ④ Desired edge of hem
- ⑤ Basting point
- ⑥ Basting

<Thick fabric>

<Normal fabric>

<Seen from the side>

6 Select a stitch.



7 Attach blind stitch foot “R”.



8 Remove the flat bed attachment to use the free arm.

9 Slide the item that you wish to sew onto the free arm, make sure that the fabric feeds correctly, and then start sewing.

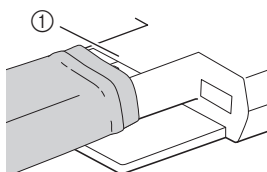

- ① Free arm

- 10** Position the fabric with the edge of the folded hem against the guide of the presser foot, and then lower the presser foot lever.

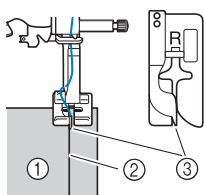

- ① Wrong side of fabric
- ② Fold of hem
- ③ Guide

- 11** Adjust the stitch width until the needle slightly catches the fold of the hem. (page 62)

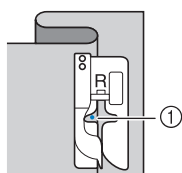

- ① Needle drop point

When you change the needle drop point, raise the needle, and then use and to decide the needle drop point. (The stitch width setting is in neither millimeters nor inches.)

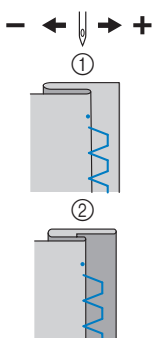

- ① Thick fabric
- ② Normal fabric

Memo

- Blind hem stitches cannot be sewn if the left needle drop point does not catch the fold. If the needle catches too much of the fold, the seam appearing on the right side of the fabric will be very large, leaving an unattractive finish.

- 12** Sew with the fold of the hem against the presser foot guide.
- 13** Press the “Start/Stop” button to stop sewing when you are finished, and raise the presser foot and needle to pull the fabric under the presser foot towards the left of the machine.
- 14** Remove the basting stitching and turn the fabric with the right side facing out.

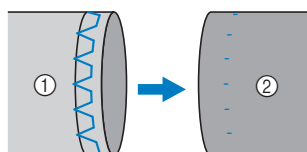

- ① Wrong side of fabric
- ② Right side of fabric

■ If the Needle Catches Too Much of the Hem Fold

The needle is too far to the left.

Press to decrease the stitch width so that the needle slightly catches the fold of the hem.



<Thick fabric>

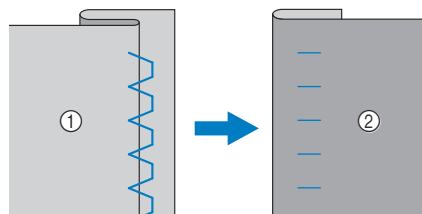

<Normal fabric>

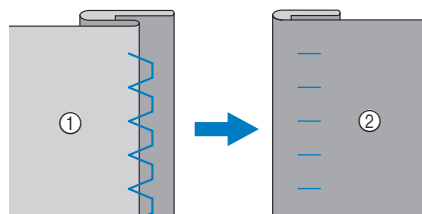

- ① Wrong side of fabric
- ② Right side of fabric

Shell Tuck Stitches

The gathers that look like shells are called “shell tucks”. They are used to decorate trims, the front of blouses or cuffs made of thin fabrics.

Memo

- For details on stitch patterns, refer to “STITCH SETTING CHART” on page 194.

- 1 Draw equally spaced lines along the bias, and then fold the fabric along the lines.

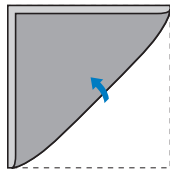

- 2 Select , and then increase the thread tension.

- 3 Attach zigzag foot “J”.

- 4 Sew while making sure that the needle drops slightly off the edge of the fabric.

One fold at a time, continue folding the fabric along the line, then sewing it.

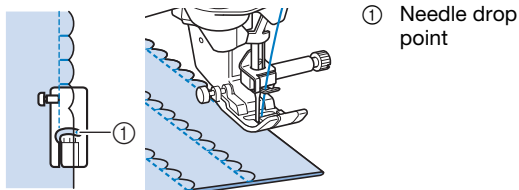

- 5 After sewing is finished, remove the fabric. Unfold the fabric, and then iron the tucks down to one side.

Scallop Stitches

The wave-shaped repeated stitch pattern that looks like shells is called “scalloping”. It is used on the collars of blouses and to decorate the edges of projects.

Memo

- For details on stitch patterns, refer to “STITCH SETTING CHART” on page 194.

- 1 Select .

- 2 Attach monogramming foot “N”.

- 3 Stitch along the edge of the fabric, making sure not to sew directly on the edge of the fabric.

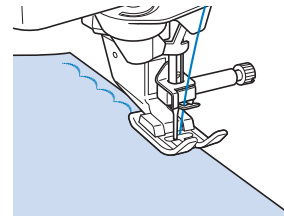

- 4 Trim along the stitches.

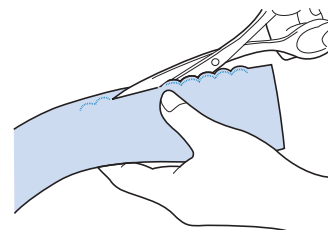

- Be careful not to cut the stitches.

Smocking Stitches

The decorative stitch created by stitching or embroidering over gathers is called “smocking”. It is used to decorate the front of blouses or cuffs.

The smocking stitch adds texture and elasticity to fabric.

Memo

- For details on stitch patterns, refer to “STITCH SETTING CHART” on page 194.

- 1 Select the straight stitch, and then adjust the stitch length to 4.0 mm (3/16 inch) and loosen the thread tension.

- 2 Attach zigzag foot “J”.

- 3 Sew parallel stitching at intervals of 1 cm (3/8 inch) and pull the bobbin threads to create gathers.

Smooth the gathers by ironing them.

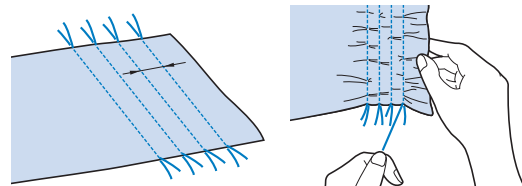

- 4 Select a stitch.

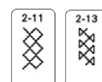

- 5 **Stitch between the straight stitches and pull out the threads for the straight stitches.**

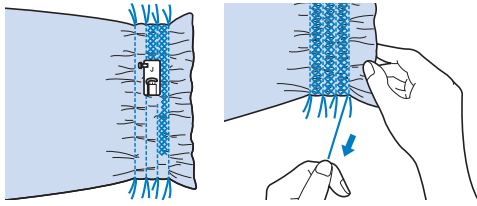

Fagoting

Stitching across an open seam is called “fagoting”. It is used on blouses and children's clothing. This stitch is more decorative when thicker thread is used.

Memo

- For details on stitch patterns, refer to “STITCH SETTING CHART” on page 194.

- 1 **Use an iron to fold the two pieces of fabric along their seams.**
- 2 **Baste the two pieces of fabric, separated by about 4 mm (3/16 inch), onto thin paper or a sheet of water soluble stabilizer.**

If you draw a line down the middle of the thin paper or water soluble stabilizer, sewing is easier.

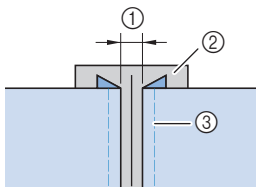

- ① About 4 mm (3/16 inch)
- ② Thin paper or water soluble stabilizer
- ③ Basting stitching

- 3 **Select a stitch.**

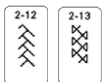

- 4 **Attach zigzag foot “J”.**
- 5 **Set the stitch width to 7.0 mm (1/4 inch).**
- 6 **Sew with the center of the presser foot aligned along the center of the two pieces of fabric.**

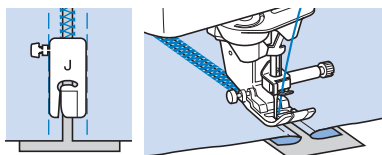

- 7 **After sewing is finished, remove the paper.**



Attaching Tape or Elastic

Memo

- For details on stitch patterns, refer to “STITCH SETTING CHART” on page 194.

- 1 **Select a straight stitch and attach presser foot “J”.**
- 2 **Set the stitch length to 4.0 mm (approx. 3/16 inch), and loosen the upper thread tension to 2.0 (page 62).**

Memo

- Be sure that neither automatic reinforcement  nor automatic thread cutting  is selected.

- 3 **Sew two rows of straight stitches on the right side of the fabric, then pull the bobbin thread to create the necessary gather.**

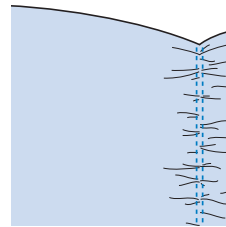

Memo

- Before sewing the straight stitch, rotate the handwheel toward you (counterclockwise) and pull up the bobbin thread. Holding the top and bobbin thread, pull a length of thread out from the rear of the machine. (Be sure that the presser foot is raised.)

- 4 **Place the tape over the gather, and hold it in place with basting pins.**

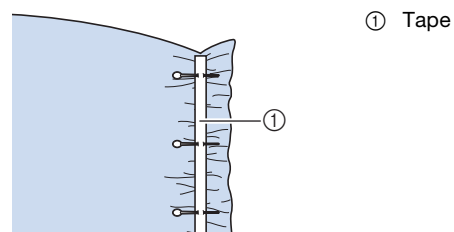

- 5 **Select a stitch.**

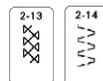

6 Sew over the tape (or elastic).

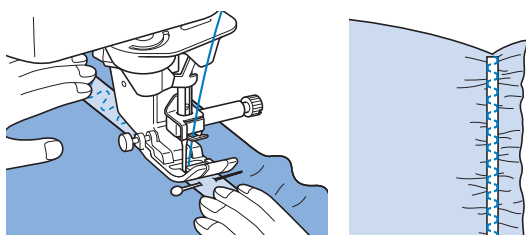

CAUTION

- Be sure the needle does not strike a basting pin, or any other objects, during sewing. The thread could tangle or the needle could break, causing injury.

7 Pull out the straight stitch threads.

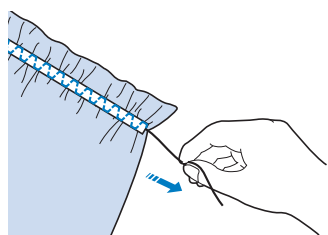

Heirloom

Hemstitching (Daisy Stitch)

Use for sewing tablecloths, decorative hems, and decorative stitching on shirt fronts.

Memo

- Use a light to medium weight homespun fabric with a little stiffness.
- For details on stitch patterns, refer to "STITCH SETTING CHART" on page 194.

1 Insert a type 130/705H, size 100/16 Wing needle.

- * This specialty sewing needle is not furnished with your machine. It must be purchased separately.

CAUTION

- A more attractive finish can be obtained if you use a "130/705H Wing" needle when sewing these stitch patterns. If using a wing needle and the stitch width has been set manually, check that the needle will not touch the presser foot by carefully rotating the handwheel toward you (counterclockwise) before starting to sew.
- When sewing with the wing needle, select a stitch width of 6.0 mm (15/64 inch) or less, otherwise the needle may bend or break.

2 Select a stitch and attach presser foot "N".

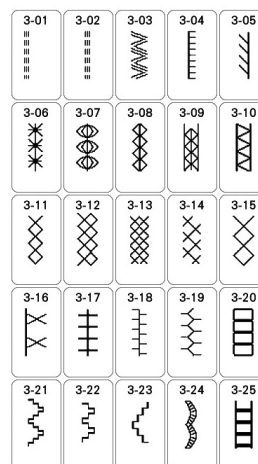

3 Start sewing.

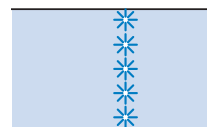

One-Step Buttonholes

With one-step buttonholes, you can make buttonholes appropriate to the size of your button.

One-step buttonholes are sewn from the front of the presser foot to the back, as shown below.

Memo

- For details on stitch patterns, refer to "STITCH SETTING CHART" on page 194.

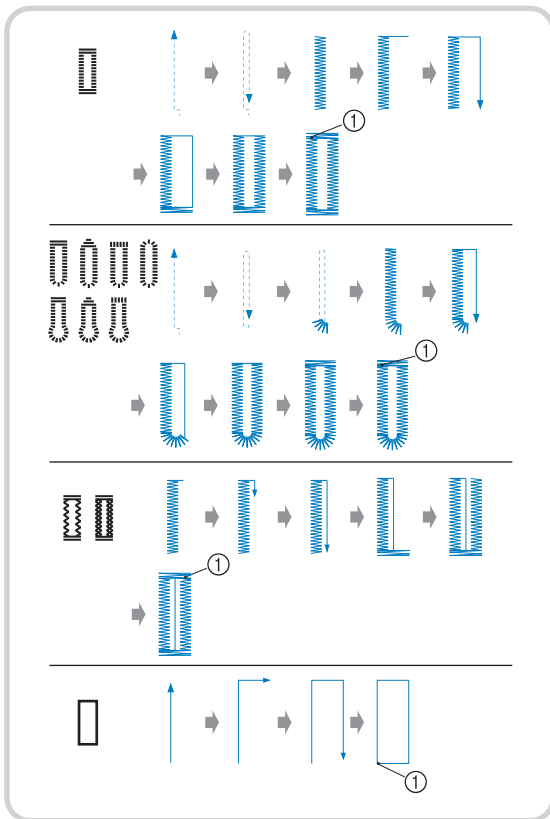

① Reinforcement stitching

1 Select a buttonhole stitch, and attach buttonhole foot "A".

Position the upper thread under the presser foot by guiding thread through the hole in the presser foot before attaching the buttonhole foot "A".

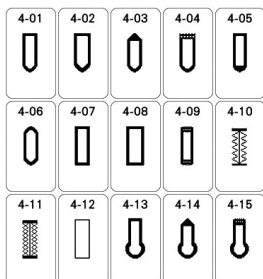

2 Mark the position and length of the buttonhole on the fabric.

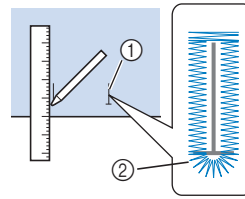

- ① Marks on fabric
- ② Buttonhole sewing

Memo

- The maximum buttonhole length is about 28 mm (approx. 1-1/16 inches) (diameter + thickness of the button).

3 Pull out the button holder plate on the presser foot, and insert the button that will be put through the buttonhole. Then tighten the button holder plate around the button.

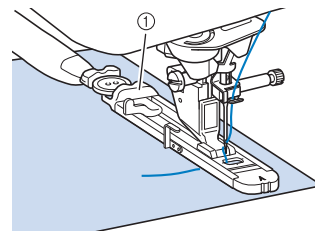

- ① Button holder plate

4 Align the presser foot with the mark on the fabric, and lower the presser foot.

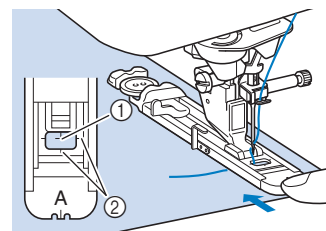

- ① Mark on the fabric
- ② Marks on the presser foot

Note

- Slide the outside frame of the buttonhole foot backward as far as possible as shown in the illustration, making sure that there is no gap behind the part of the foot marked "A". If the buttonhole foot is not slid back as far as possible, the buttonhole will not be sewn at the correct size.

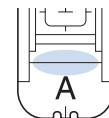

- 5** Lower the buttonhole lever so that it is positioned behind the metal bracket on the buttonhole foot.

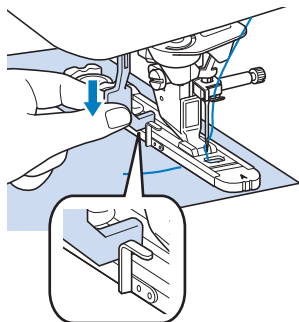

- 6** Gently press the end of the upper thread, and then start sewing.

* Feed the fabric carefully by hand while the buttonhole is sewn.

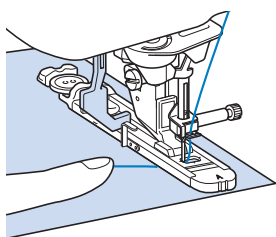

→ Once sewing is completed, the machine automatically sews reinforcement stitches, and then stops.

- 7** Insert a pin along the inside of one of the bar tacks, and then insert the seam ripper into the center of the buttonhole and cut towards the pin.

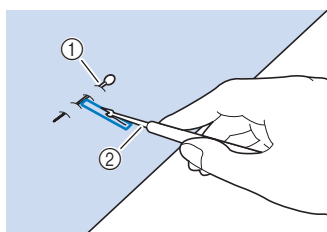

- ① Basting pin
② Seam ripper

⚠ CAUTION

- When using the seam ripper to open the buttonhole, do not put your hand or finger in the path of the ripper. The ripper may slip and cause injury. Do not use the seam ripper in any other way than how it is intended.

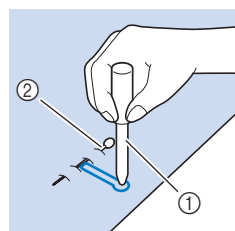

📌 Memo

- For keyhole buttonholes, use the eyelet punch to make a hole in the rounded end of the buttonhole. Then insert a pin along the inside of one of the bar tacks, insert a seam ripper into the hole made with the eyelet punch, and cut towards the pin.



- ① Eyelet punch
② Basting pin

■ Sewing Stretch Fabrics

When sewing on stretch fabric with  or , sew the buttonhole stitches over a gimp thread.

- 1** Hook the gimp thread onto the back of presser foot "A". Insert the ends into the grooves at the front of the presser foot, and then temporarily tie them there.

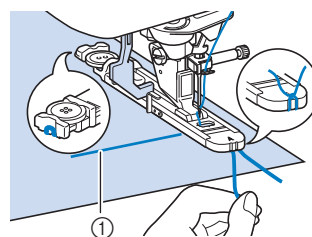

- ① Upper thread

- 2** Lower the presser foot and start sewing.

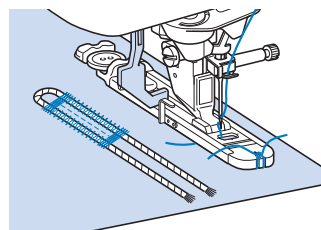

- 3** Once sewing is completed, gently pull the gimp thread to remove any slack, and trim off any excess.

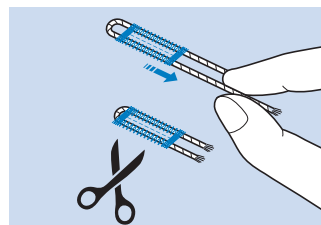

■ Odd Shaped Buttons/Buttons that Do Not Fit into the Button Holder Plate

Use the markings on the presser foot scale to set the size of the buttonhole. Two marks on the presser foot scale equal 5 mm (approx. 3/16 inch). Add the button diameter and thickness together, and then set the plate at the calculated value.

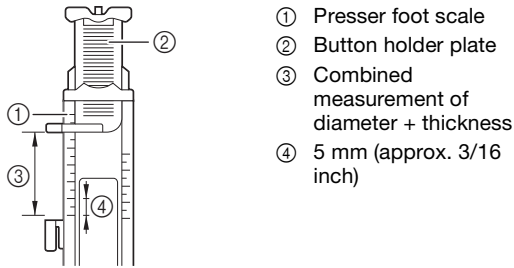

📖 Memo

- For example, for a button with a diameter of 15 mm (approx. 9/16 inch) and a thickness of 10 mm (approx. 3/8 inch), the scale should be set at 25 mm (approx. 1 inch).

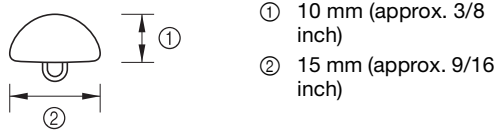

Four-Step Buttonholes

You can sew 4-step buttonholes using the following 4 stitches together. You can sew any desired length for the buttonhole when using 4-step buttonholes. 4-step buttonholes are a good option when attaching oversize buttons.

📖 Memo

- For details on stitch patterns, refer to “STITCH SETTING CHART” on page 194.

Four-step buttonholes are sewn as shown below.

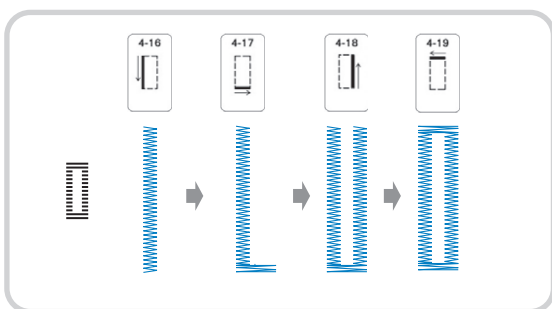

- 1 Mark the position and length of the buttonhole on the fabric.

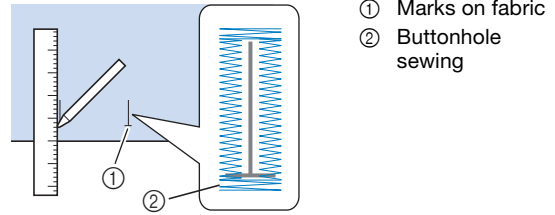

- 2 Attach monogramming foot “N”, and select stitch  to sew the left side of the buttonhole.

- 3 Press the “Start/Stop” button to start sewing.

- 4 Sew the desired length for the buttonhole and press the “Start/Stop” button again.

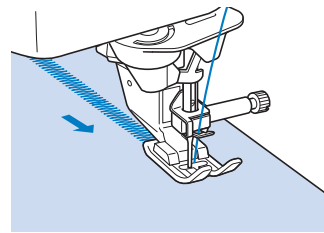

- 5 Select stitch  to sew the bar tack and press the “Start/Stop” button.

→ The machine will automatically stop after sewing the bar tack.

- 6 Select stitch  to sew the right side of the buttonhole, and press the “Start/Stop” button to begin sewing.

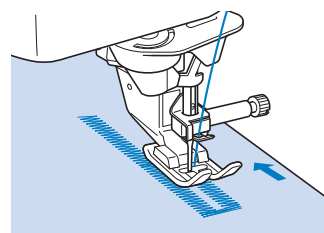

- 7 Sew the right side of the buttonhole and press the “Start/Stop” button again.

* Sew the right side of the buttonhole the same length as the left.

- 8 Select stitch  to sew the bar tack and then press the “Start/Stop” button.

→ The machine will automatically sew off the bar tack tie and stop when the bar tack is complete.

- 9 Raise the presser foot and remove the fabric.



- 10 Open the buttonhole (page 89).

Darning

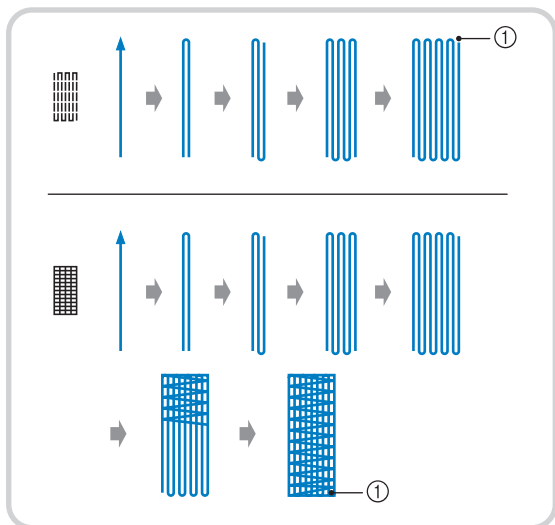
Use darning stitches for mending and other applications. Darning is performed by sewing from the front of the presser foot to the back as shown below.



① Reinforcement stitches

- 1** Select  or , and attach buttonhole foot "A".

Position the upper thread under the presser foot by guiding thread through the hole in the presser foot before attaching the buttonhole foot "A".

- 2** Set the scale to the desired length of the darning.

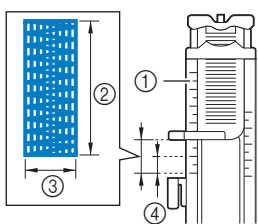

- ① Presser foot scale
- ② Completed length measurement
- ③ Width 7 mm (approx. 1/4 inch)
- ④ 5 mm (approx. 3/16 inch)

Memo

- The maximum length for darning is 28 mm (approx. 1-1/16 inches).

- 3** Check that the needle drops at the desired position and lower the presser foot, making sure the upper thread passes underneath the buttonhole foot.

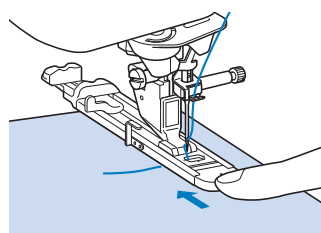

Note

- Slide the outside frame of the buttonhole foot backward as far as possible as shown in the illustration, making sure that there is no gap behind the part of the foot marked "A". If the buttonhole foot is not slid back as far as possible, the buttonhole will not be sewn at the correct size.

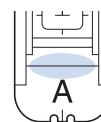

- 4** Lower the buttonhole lever so that it is positioned behind the metal bracket on the buttonhole foot.

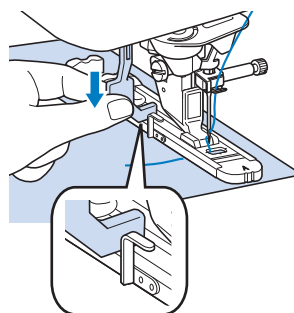

- 5** Gently press the end of the upper thread, and then press the "Start/Stop" button to start the machine.

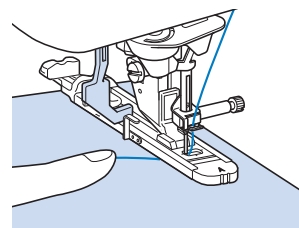

→ Once sewing is completed, the machine automatically sews reinforcement stitches, and then stops.

Bar Tacks

Use bar tacks to reinforce areas that will be subject to strain, such as pocket corners.

Memo

- For details on stitch patterns, refer to "STITCH SETTING CHART" on page 194.

1 Select .

2 Attach buttonhole foot "A" and set the scale to the length of the bar tack you wish to sew.

Position the upper thread under the presser foot by guiding thread through the hole in the presser foot before attaching the buttonhole foot "A".

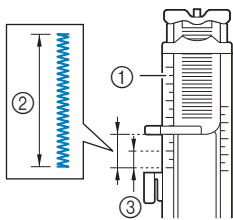

- ① Presser foot scale
- ② Completed length measurement
- ③ 5 mm (approx. 3/16 inch)

Memo

- Bar tacks can be between 5 mm (approx. 3/16 inch) and 28 mm (approx. 1-1/16 inches).

3 Set the fabric so that the pocket moves toward you during sewing.

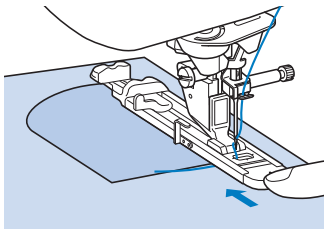

Note

- Slide the outside frame of the buttonhole foot backward as far as possible as shown in the illustration, making sure that there is no gap behind the part of the foot marked "A". If the buttonhole foot is not slid back as far as possible, the buttonhole will not be sewn at the correct size.

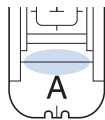

4 Check the first needle drop point and lower the presser foot.

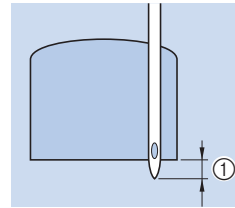

- ① 2 mm (approx. 1/16 inch)

5 Lower the buttonhole lever so that it is positioned behind the metal bracket on the buttonhole foot.

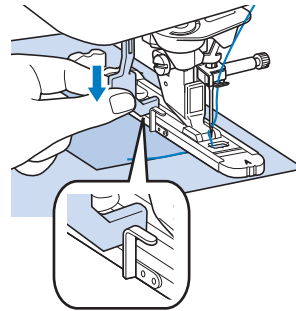

6 Gently press the end of the upper thread and start sewing.

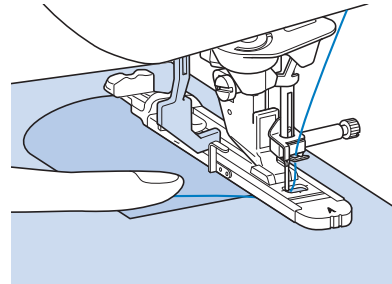

→ When sewing is completed, the machine will sew reinforcement stitches and stop automatically.

Bar Tacks On Thick Fabrics

Place a piece of folded fabric or cardboard beside the fabric being sewn to level the buttonhole foot and allow for easier and even feeding.

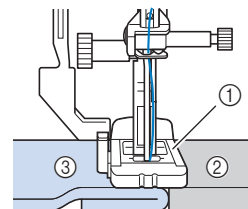

- ① Presser foot
- ② Thick paper
- ③ Fabric

Button Sewing

Buttons with 2 or 4 holes can be attached, using the machine.

Memo

- For details on stitch patterns, refer to "STITCH SETTING CHART" on page 194.

1 Select .

→ The feed dogs are lowered automatically.

- Do not use the automatic thread cutting function when sewing buttons. Otherwise, you will lose the thread ends.

2 Raise the presser foot.

3 Attach button sewing foot "M", slide the button along the metal plate and into the presser foot, and lower the presser foot.

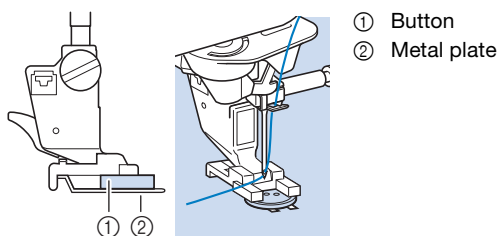

4 Rotate the handwheel toward you (counterclockwise) to check that the needle goes into each hole correctly.

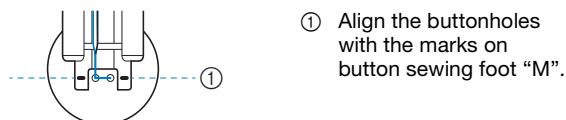

- * If the needle does not reach the holes on the left side, adjust the stitch width.
- * To attach the button more securely, repeat the process.

5 Gently press the end of the upper thread and start sewing.

→ The machine stops automatically when sewing is finished.

CAUTION

- Make sure the needle does not strike the button during sewing. The needle may break and cause injury.

6 From the wrong side of the fabric, pull the end of the bobbin thread to pull the upper thread through to the wrong side of the fabric. Tie the two thread ends together and cut the threads.

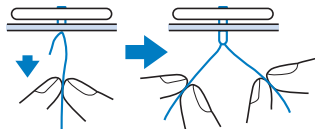

7 After the button is attached, select another stitch and rotate the handwheel toward you (counterclockwise) to raise the feed dogs.

Attaching 4-Hole Buttons

Sew the two holes closest to you. Then raise the presser foot and move the fabric so that the needle goes into the next two holes, and sew them in the same way.

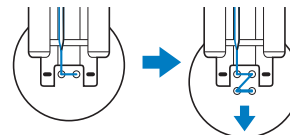

Attaching a Shank to the Button

1 Pull the shank lever toward you before sewing.

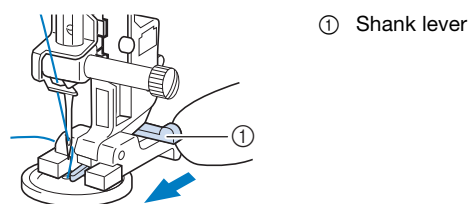

2 Pull the two ends of the upper thread between the button and the fabric, wind them around the shank, and then tie them firmly together.

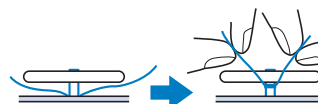

3 Tie the ends of the bobbin thread from the beginning and end of sewing together on the wrong side of the fabric.

4 Cut off any excess thread.

Eyelet

Use this stitch for making belt holes and other similar applications.

Memo

- For details on stitch patterns, refer to “STITCH SETTING CHART” on page 194.

1 Select a stitch.

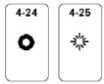

2 Use in either the stitch width display or the stitch length display to choose the size of the eyelet (page 62).

3 Attach monogramming foot “N”, then rotate the handwheel toward you (counterclockwise) to check the needle drop point.

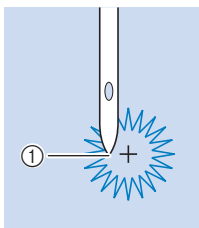

① Needle drop point

4 Lower the presser foot and start sewing.

→ When sewing is finished, the machine sews reinforcement stitches and stops automatically.

5 Use the eyelet punch to make a hole in the center of the stitching.

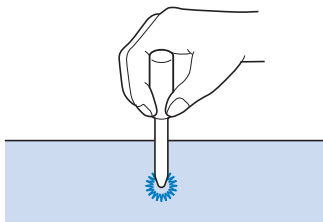

Multi-Directional Sewing (Straight Stitch and Zigzag Stitch)

Use these stitch patterns to attach patches or emblems to pant legs, shirt sleeves, etc.

Memo

- For details on stitch patterns, refer to “STITCH SETTING CHART” on page 194.

1 Remove the flat bed attachment to use the free-arm.

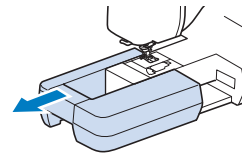

Memo

- Insert the tubular piece of fabric onto the free-arm, and then sew in the order shown in the illustration.

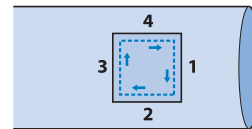

2 Select and attach monogramming foot “N”.

3 Set the needle in the fabric at the sewing start point, and sew seam “1” as shown.

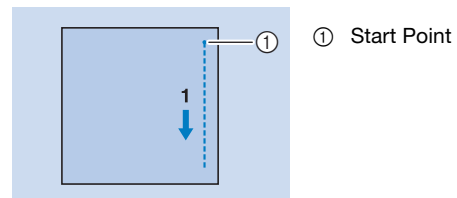

① Start Point

4 Select and sew seam “2” as shown.

- * The fabric will move sideways, guide the fabric by hand to keep sewing straight.

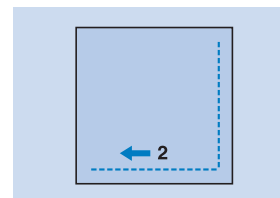

- 5 Select  and sew seam "3" as shown.

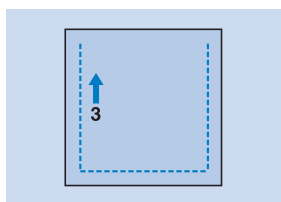

→ The fabric feeds forward while stitching backward.

- 6 Select  and sew seam "4" as shown.

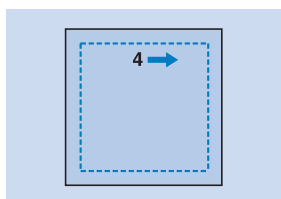

→ The seam will be connected to the starting point of seam 1.

Zipper Insertion

⚠ CAUTION

- When using zipper foot "I", make sure the straight stitch, middle needle position is selected. Rotate the handwheel toward you (counterclockwise) to make sure the needle does not strike the presser foot. If another stitch is selected, the needle will strike the presser foot, causing the needle to break and possibly causing injury.
- Make sure the needle does not strike the zipper during sewing. If the needle strikes the zipper, the needle may break, leading to injury.

Memo

- For details on stitch patterns, refer to "STITCH SETTING CHART" on page 194.

■ Centered Zipper

Use for bags and other such applications.

- 1 Select .
- 2 Attach presser foot "J" and sew straight stitches up to the zipper opening. Change to a basting stitch (page 73) and sew to the top of the fabric.

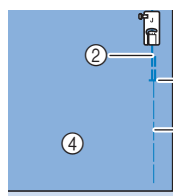

- ① Basting stitches
- ② Reverse stitches
- ③ End of zipper opening
- ④ Wrong side

- 3 Press the seam allowance open and attach the zipper with a basting stitch in the middle of each side of the zipper tape.

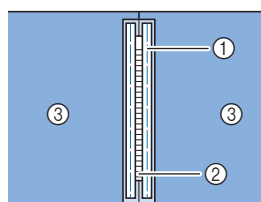

- ① Basting stitches
- ② Zipper
- ③ Wrong side

- 4 Remove presser foot "J". Align the right side of the pin in zipper foot "I" with the presser foot holder, and attach the zipper foot.

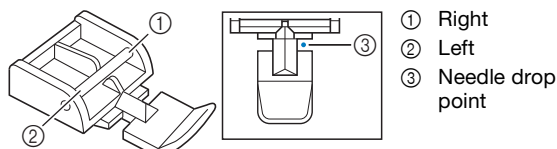

- 5 Topstitch 7 to 10 mm (approx. 1/4 to 3/8 inch) from the seamed edge of the fabric, then remove the basting.

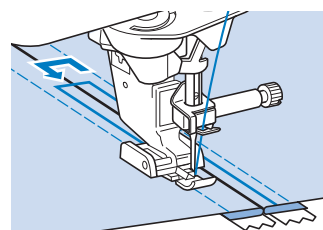

■ Inserting a Side Zipper

Use for side zippers in skirts or dresses.

- 1 Select .

Note

- Make sure you sew using the middle needle position.

2 Attach presser foot "J" and sew straight stitches up to the zipper opening. Change to a basting stitch and sew to the top of the fabric.

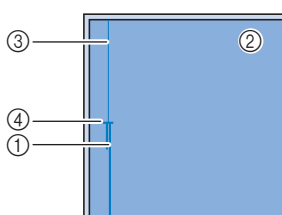

- ① Reverse stitches
- ② Wrong side of fabric
- ③ Basting stitches
- ④ End of zipper opening

3 Press the seam allowance open and align the folded hem along the teeth of the zipper, while maintaining 3 mm (approx. 1/8 inch) of sewing space.

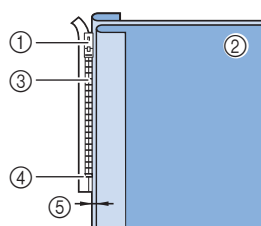

- ① Zipper pull tab
- ② Wrong side of fabric
- ③ Zipper teeth
- ④ End of zipper opening
- ⑤ 3 mm (approx. 1/8 inch)

4 Remove presser foot "J".

5 Align the right side of the pin in zipper foot "1" with the presser foot holder, and attach the presser foot.

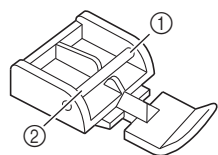

- ① Right
- ② Left
- ③ Needle drop point

6 Set the presser foot in the 3 mm (approx. 1/8 inch) margin.

7 Starting from the end of the zipper opening, sew to a point about 5 cm (2 inches) from the edge of the fabric, then stop the machine.

8 Pull down the zipper slider, then continue sewing to the edge of the fabric.

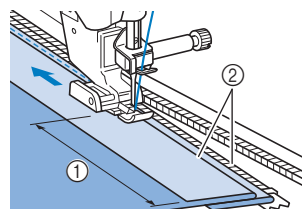

- ① About 5 cm (2 inches)
- ② 3 mm (approx. 1/8 inch)

9 Close the zipper, turn the fabric over, and sew a basting stitch.

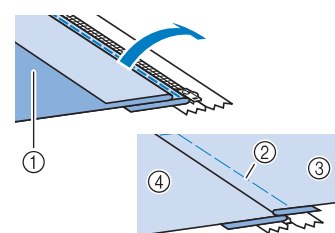

- ① Front of the skirt (wrong side of fabric)
- ② Basting stitches
- ③ Front of the skirt (right side of fabric)
- ④ Back of the skirt (right side of fabric)

10 Remove the presser foot, and reattach it so that the left side of the pin is attached to the presser foot holder.

* When sewing the left side of the zipper, the needle should drop on the right side of the presser foot. When sewing the right side of the zipper, the needle should drop on the left side of the presser foot.

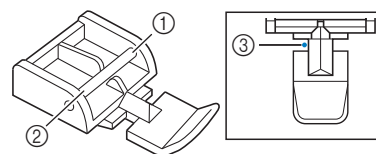

- ① Right
- ② Left
- ③ Needle drop point

11 Set the fabric so that the left edge of the presser foot touches the edge of the zipper teeth.

12 Sew reverse stitches at the top of the zipper, then continue sewing.

13 Stop sewing about 5 cm (2 inches) from the edge of the fabric, leave the needle in the fabric, and remove the basting stitches.

14 Open the zipper and sew the rest of the seam.

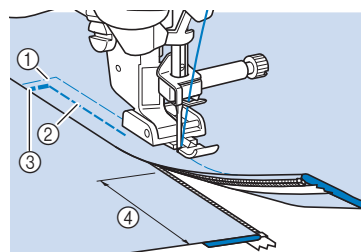





- ① Basting stitches
- ② 7 to 10 mm (approx. 1/4 inch to 3/8 inch)
- ③ Reverse stitches
- ④ About 5 cm (2 inches)



MAKING ADJUSTMENTS

Your stitch pattern may sometimes turn out poorly, depending on the type or thickness of fabric, the stabilizer material used, sewing speed, etc. If your sewing does not turn out well, sew trial stitches using the same conditions as the real sewing, and adjust the stitch pattern as explained below. If the stitch pattern does not turn out well even after making adjustments based on the stitch pattern described below, make adjustments for each stitch pattern individually.

Memo

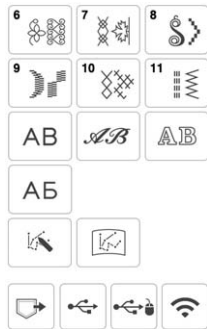
- For details on stitch patterns, refer to “STITCH SETTING CHART” on page 194.
- This adjustment can be made to  (1-36 Quilting stippling stitch),  (2-21 Decorative stippling stitch),  (4-24 Eyelet stitch),  (4-25 Star eyelet stitch),  (Q-15 Quilting stippling stitch) and stitch patterns from the following categories.



- 1 Press  and select  (6-284).
- 2 Attach monogramming foot “N” and sew the stitch pattern.
Be sure to use monogramming foot “N”. Adjustments may not be made correctly with any other presser foot.
- 3 Compare the finished stitch pattern to the illustration of the correct stitch pattern below.

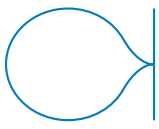

- 4 Press , and then adjust the stitch pattern with the [Fine Adjust Vert.] or [Fine Adjust Horiz.] displays.



- If the stitch pattern is bunched:
Press  in the [Fine Adjust Vert.] display.
→ The displayed value increases each time the button is pressed and the stitch pattern will lengthen.

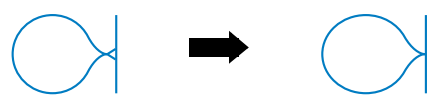

- If the stitch pattern has gaps:
Press  in the [Fine Adjust Vert.] display.
→ The displayed value decreases each time the button is pressed and the stitch pattern will shorten.

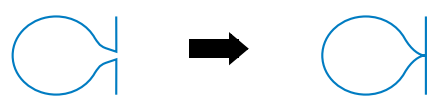

- If the stitch pattern is skewed to the left:
Press  in the [Fine Adjust Horiz.] display.
→ The displayed value increases each time the button is pressed and the stitch pattern will slide to the right.

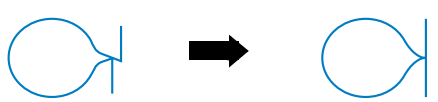



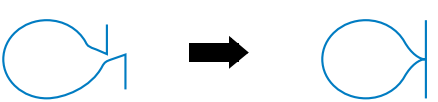

- If the stitch pattern is skewed to the right:
Press  in the [Fine Adjust Horiz.] display.
→ The displayed value decreases each time the button is pressed and the stitch pattern will slide to the left.



- 5 Sew the stitch pattern again.
* If the stitch pattern still comes out poorly, make adjustments again. Adjust until the stitch pattern comes out correctly.
* You can sew with the setting screen on the display.
- 6 Press  to return to the original screen.



MAKING STEP STITCH PATTERNS (FOR 7MM SATIN STITCH PATTERNS ONLY)

You can use   with 7mm satin stitch patterns to create a step effect, also called step stitch patterns.

- Press   to move the stitch pattern a distance equal to half of the stitch pattern's size to the left or right.
- To combine the stitch patterns, refer to page 58.

Example:



1 Press  so that it displays .

2 Press  (9-11).

3 Press .



→ The next stitch pattern will move to the right.

4 Press  (9-11) again.

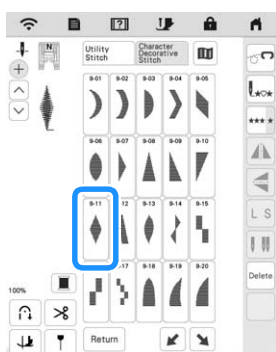

5 Press .



→ The next stitch pattern will move to the left.

6 Press .

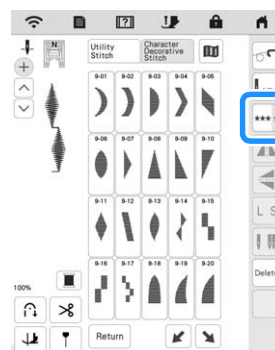

→ The entered stitch pattern is repeated.

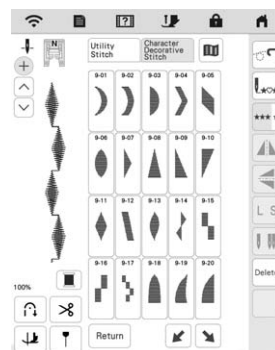

USING THE MEMORY FUNCTION

Saving Stitch Patterns

You can save stitch patterns that you have customized in the machine's memory or USB media.

Note

- Do not turn the main power to OFF while the [Saving...] screen is displayed. You will lose the stitch pattern you are saving.

1 Press **Memory**.

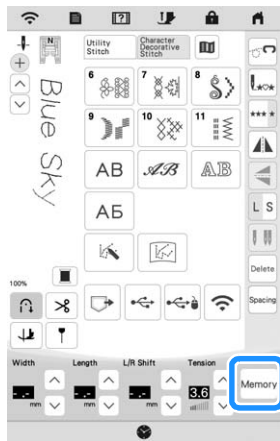

2 Press the desired destination to start saving.



- ① Save to the machine's memory.
- ② Save to the USB media.
The stitch pattern is saved in a folder labeled [bPocket]. When saving the stitch pattern in a USB media, insert the USB media into the USB port on the machine.

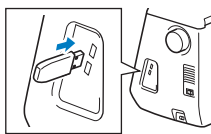

Retrieving Stitch Patterns

Retrieve stitch patterns saved in the machine's memory or USB media.

1 Press the desired destination.



- ① Retrieve from the machine's memory.
- ② Retrieve from a USB media.
When retrieving stitch patterns from a USB media, insert the USB media into the USB port on the machine.
- ③ Retrieve via the wireless network.

Memo

- If the stitch pattern to be retrieved is in a folder of the USB media, press the key for that folder. Press to return to the previous screen.

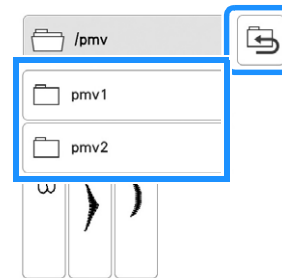

- Folders in the USB media cannot be created with the machine.
- Press to retrieve stitch patterns via the wireless network. For detailed procedures, refer to PE-DESIGN manual (Version 11 or higher).
- For details on supported file extensions, refer to "SPECIFICATIONS" on page 192.

2 Select the desired stitch pattern, and then press .

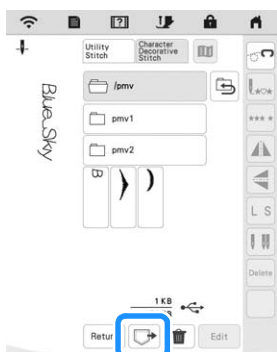

Note

- When you press , the selected stitch pattern will be deleted permanently.

MY CUSTOM STITCH

■ Designing a Stitch

By using the MY CUSTOM STITCH function, you can register stitches you have created yourself. You can also sew designs combining MY CUSTOM STITCH creations with built-in characters (page 58).

 **Memo**

- Stitches that you create with MY CUSTOM STITCH can be a maximum of 7 mm (approx. 9/32 inch) wide and 37 mm (approx. 1-1/3 inches) long.

1 Draw the stitch design on the grid. Place points where the stitch pattern intersects with the grid, and connect all the points with a line.

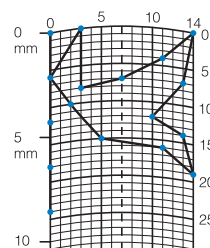

 **Memo**

- Simplify the design so that it can be sewn as a continuous line. For a more attractive stitch, close the design by intersecting lines.



If the design is to be repeated and linked, the start point and end point of the design should be at the same height.



2 Determine the x and y coordinates of each of the marked points.

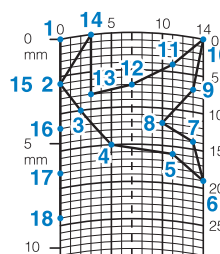

MY CUSTOM STITCH Screen

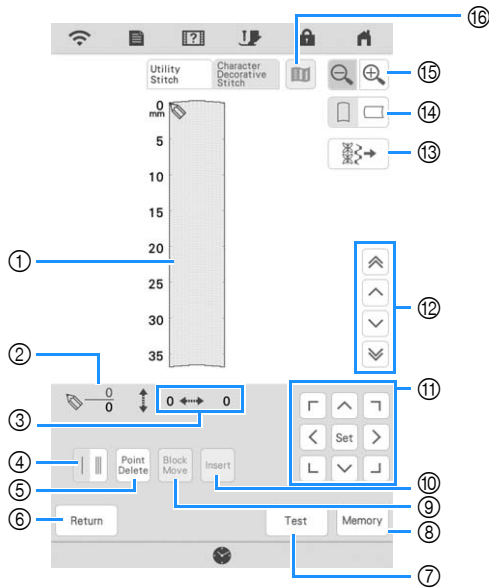

- ① This area displays the stitch being created.
- ② Displays the number of the present set point over the total number of points in the stitch.
- ③ Displays the y-coordinate of over the x-coordinate of .

No.	Display Key Name	Explanation	Page
④	 Single/triple stitching key	Press this key to select whether one or three stitches will be sewn between two points.	102
⑤	 Point delete key	Press this key to delete a selected point.	—
⑥	 Return key	Press this key to exit the entering stitch data screen.	—
⑦	 Test key	Press this key to sew a test of the stitch.	—
⑧	 MY CUSTOM STITCH memory key	Press this key to store the stitch being created.	—
⑨	 Block move key	Press this key to group points together and move them together.	102
⑩	 Insert key	Press this key to insert new points on the stitch design.	102
⑪	 Arrow keys and set key	Use these keys to move over the display area, and press the set key in the center to set a point on the stitch design.	101-102

No.	Display Key Name	Explanation	Page
⑫	 Point-to-point key	Use these keys to move from point to point on the stitch, or to the first or last point entered on the stitch.	102
⑬	 Stitch edit key	Press this key to edit the utility stitches in the machine.	—
⑭	 Grid direction key	Press this key to change the direction of the grid.	—
⑮	 Enlarger key	Press this key to see an enlarged version of the stitch being created.	—
⑯	 Image key	Press this key to view an image of the stitch.	—

- ① Press and then .
- ② Press .

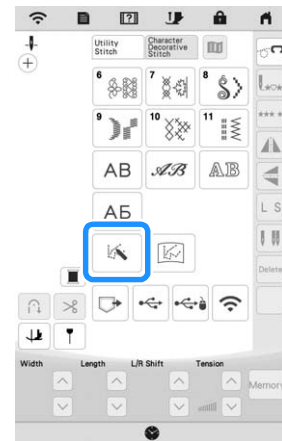

- ③ Use to move to the coordinates of the first point on the grid.
- ④ Press to add the point indicated by .

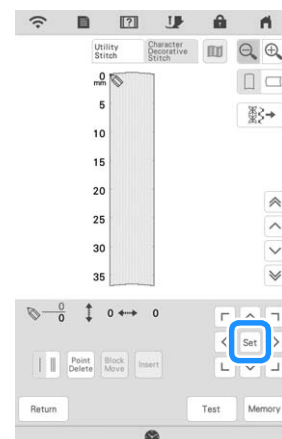

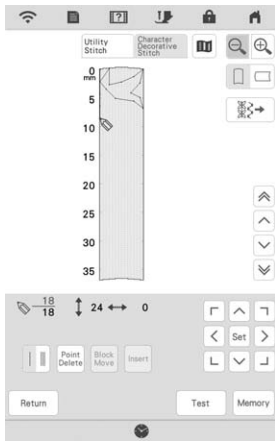

- 5 Select whether single stitch or triple stitches will be sewn between the first two points.
 - * To sew three stitches, press the key so that it appears as .
- 6 Repeat the steps for each point that you have drawn on the grid until the stitch design is drawn on the screen as a continuous line.



- 7 Once you finish entering the stitch data, press  to save the stitch pattern.

■ Moving a Point





- 1 Press  or  to move  to the point that you want to move.



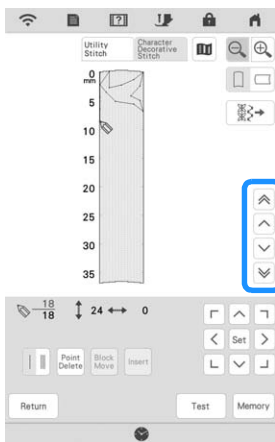

- 2 Use  to move the point.

■ Moving Part or All of the Design

- 1 Press  or  to move  to the first point of the section that you want to move.



- * To move  to the first point, press .
- * To move  to the last point, press .

- 2 Press .
 - The selected point and all points that were entered after it are selected.
- 3 Press  or  to move the section and press .

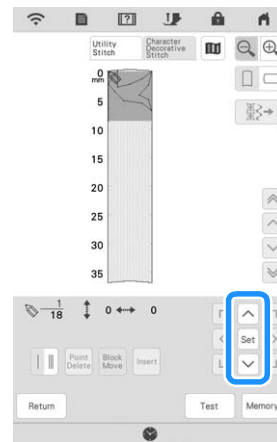





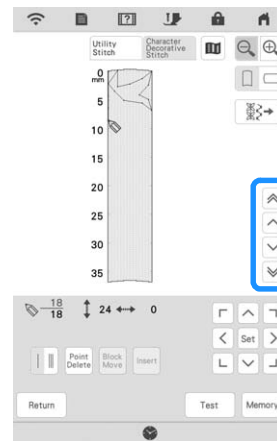

→ The section will be moved.

■ Inserting New Points

- 1 Press  or  to move  to a place on the design where you want to add a new point.



- * To move  to the first point, press .
- * To move  to the last point, press .

- 2 Press  to insert a new point.
- 3 Use  to move the point.

Retrieving Saved Stitch Patterns

1 Press .

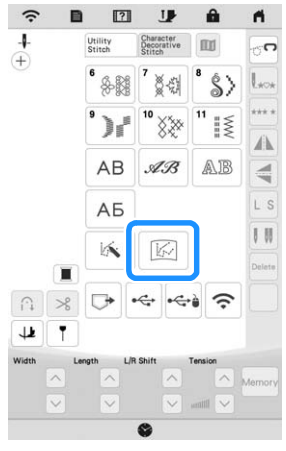

2 Select the device to retrieve the stitch pattern from.



3 Select the stitch pattern.

* You can start sewing when this screen is displayed.

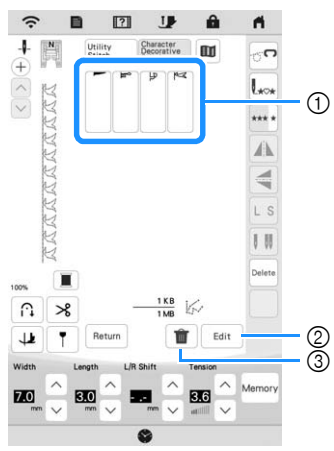

- ① Stored stitch patterns
- ② Edit the stitch pattern.
- ③ Delete the stitch pattern.



Chapter **4**
Basic Embroidery



BEFORE EMBROIDERING

Embroidery Step by Step

Follow the steps below to prepare the machine for embroidery.

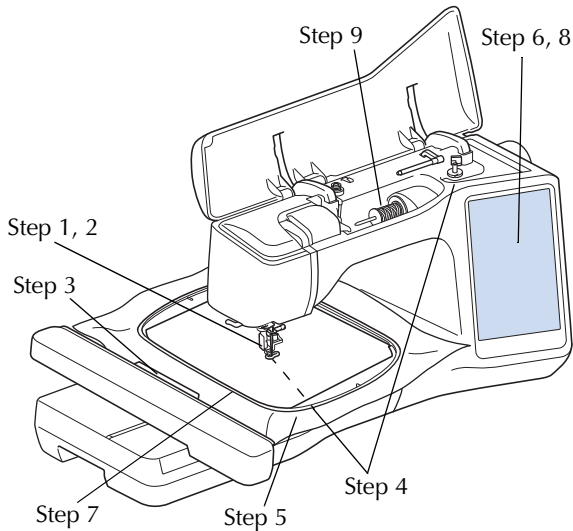

Step #	Aim	Action	Page
1	Presser foot attachment	Attach embroidery foot “W+” with LED pointer.	106
2	Checking the needle	Use needle 75/11 for embroidery.	48
3	Embroidery unit attachment	Attach the embroidery unit.	107
4	Bobbin thread setup	For the bobbin thread, wind embroidery bobbin thread and set it in place.	36
5	Fabric preparation	Attach a stabilizer material to the fabric, and hoop it in the embroidery frame.	127
6	Pattern selection	Turn the main power to ON, and select an embroidery pattern.	108
7	Embroidery frame attachment	Attach the embroidery frame to the embroidery unit.	130
8	Checking the layout	Check and adjust the size and position of the embroidery.	131
9	Embroidery upper thread setup	Set up embroidery upper thread according to the pattern.	42

Attaching Embroidery Foot “W+” with LED Pointer

⚠ CAUTION

- When attaching an embroidery foot, always press  on the screen. You may accidentally press the “Start/Stop” button and possibly cause injury.
- Be sure to use embroidery foot “W+” with LED pointer when doing embroidery. Using another embroidery foot may cause the needle to strike the embroidery foot, causing the needle to bend or break and possibly cause injury.

- 1 Remove the presser foot and presser foot holder. (page 50)
- 2 Position the embroidery foot “W+” with LED pointer on the presser foot bar by aligning the notch of the presser foot to the large screw.

Side view

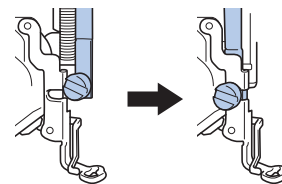

- 3 Hold the embroidery foot in place with your right hand, and then use the disc-shaped screwdriver to securely tighten the presser foot holder screw.

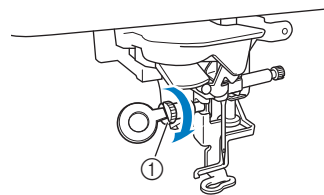



① Presser foot holder screw

⚠ CAUTION

- Use the disc-shaped screwdriver to firmly tighten the presser foot holder screw. If the screw is loose, the needle may strike the embroidery foot and possibly cause injury.

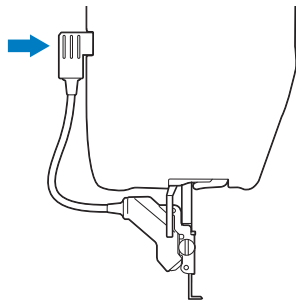
- 4 Plug the connector of the embroidery foot “W+” with LED pointer into the jack on the back left side of your machine.



- 5 Press  to unlock all keys and buttons.
→ All keys and operation buttons are unlocked, and the previous screen is displayed.



About the Embroidery Unit

⚠ CAUTION

- Before attaching or removing the embroidery unit, be sure to turn off the machine. Otherwise, injuries may occur if one of the operation buttons is accidentally pressed.
- Do not move the machine with the embroidery unit attached. The embroidery unit could fall off and cause injury.
- Keep your hands and foreign objects away from the embroidery carriage and frame when the machine is embroidering. Otherwise, injuries or damage may result.
- To avoid distorting your embroidery design, do not touch the embroidery carriage and frame when the machine is embroidering.
- Do not push on the carriage when installing the embroidery unit onto the machine. Moving the carriage may damage the embroidery unit.
- Allow sufficient space around the embroidery unit. Otherwise, the embroidery unit could fall off foreign object, and may cause injury.
- Do not touch the embroidery carriage until the initialization finishes.
- Be sure to turn off the power before attaching or removing the embroidery unit. Otherwise, the machine may be damaged.
- Do not touch the inner connector of the embroidery unit. The pins on the embroidery unit connection may be damaged.
- Do not apply strong force to the embroidery unit carriage or pick up the unit by the carriage. Otherwise, the embroidery unit may be damaged.
- Store the embroidery unit in a safe place to prevent damage to the unit.

- Do not carry the embroidery unit by holding the carriage or release lever compartment.

💡 Note

- You can also sew utility/decorative stitches with the embroidery unit attached. Touch  and . The feed dog will automatically raise for utility and decorative stitching.

■ Attaching the Embroidery Unit

- 1 Turn the main power to OFF, and remove the flat bed attachment.

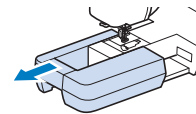

- 2 Insert the embroidery unit connection into the machine connection port. Push lightly on the connection port cover until the unit clicks into place.

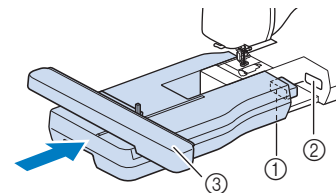



- ① Embroidery unit connection
- ② Machine connection port
- ③ Carriage

💡 Note

- Be sure there is no gap between the embroidery unit and the machine. If there is a gap, the embroidery patterns will not embroider with the correct registration.

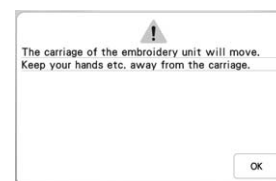
- 3 Turn the main power to ON.
→ The following message will appear.



- 4 Press  .
→ The carriage will move to the initialization position.

■ Removing the Embroidery Unit

- 1 Press , then press .

→ The carriage will move to the removal position.

CAUTION

- Always remove the embroidery frame before pressing . Otherwise, the frame may strike the embroidery foot, and possibly cause injury.

- 2 Turn the main power to OFF.

- 3 Squeeze the release lever, and pull the embroidery unit away from the machine.

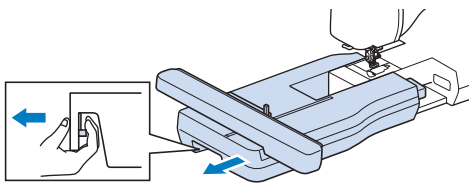

SELECTING PATTERNS

■ Copyright Information

The patterns stored in the machine and patterns sold separately are intended for private use only. Any public or commercial use of copyrighted patterns is an infringement of copyright law and is strictly prohibited.

■ About Embroidery Patterns

There are many character and decorative embroidery patterns stored in the machine's memory (see the "Quick Reference Guide" for a full summary of patterns in the machine's memory or visit "<http://s.brother/cmeac/>"). You can also use patterns sold separately.

Once the machine has finished the initialization and the carriage has moved to the start position, the pattern selection screen appears.

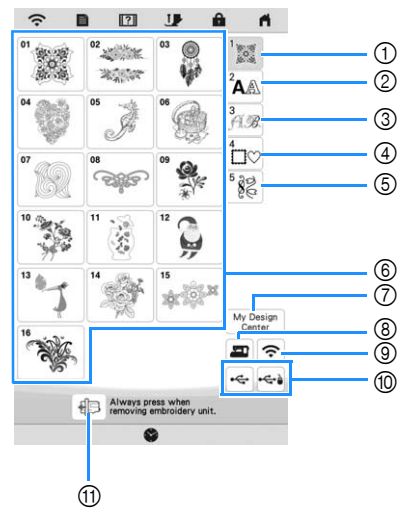

- ① Embroidery patterns
- ② Character patterns
- ③ Decorative alphabet patterns
- ④ Frame patterns
- ⑤ Utility embroidery patterns
- ⑥ Pattern type selection keys
- ⑦ My Design Center (page 156)
- ⑧ Patterns saved in the machine's memory (page 150)
- ⑨ Patterns to be transferred via the wireless network (page 150)
- ⑩ Patterns saved in USB media (page 150)
- ⑪ Move the embroidery unit carriage to the storage position.

Selecting Embroidery Patterns

- 1 Press the category tab and then press the pattern type selection key or pattern key you want to embroider.

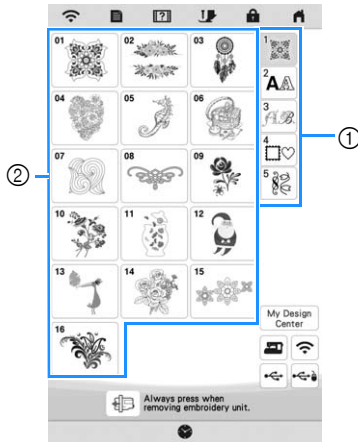

- ① Pattern category tab
- ② Pattern type/pattern selection key

- 2 Select a pattern.



- * Press the category tab or **Return** to return to the previous screen.
- The selected pattern is displayed.

- 3 Press **Set** to set the pattern.

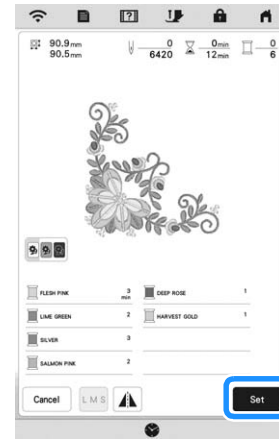

- * Press to darken the background color for the pattern image with bright thread colors, to get a clearer image.
- The pattern is designated with a red box around it on the edit screen.

- 4 Press **Edit** to edit the selected pattern. (page 114)

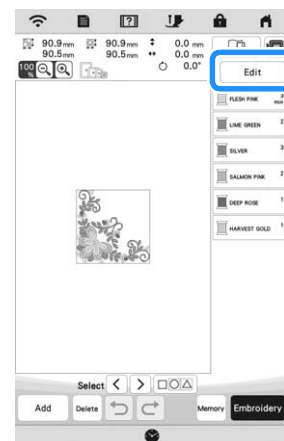

- 5 Press **Embroidery**.
- The embroidery screen appears.

6 Press **Layout** to edit the pattern before embroidering. (page 125)

* To return to the edit screen, press **Return**.

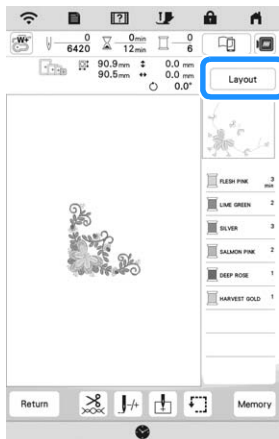



7 Start embroidering. (page 135)

Selecting Character Patterns

1 Press **AA**.

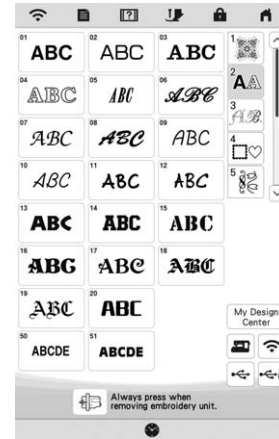
2 Press the key of the font you want to embroider.



*  : View the next page.

 : View the previous page.

3 Select the character category and then type in the text. (page 111)



4 Press **Set**.

→ The edit screen appears.

5 Follow the steps from 4 to 7 of "Selecting Embroidery Patterns" on page 109.

Character Pattern Input Keys

Memo

- If a key display is grayed out, you cannot use that function with the selected pattern.

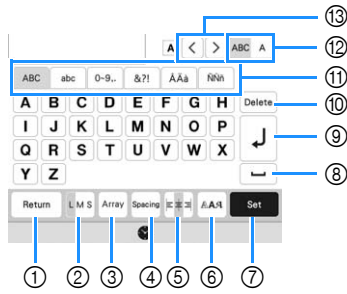

No.	Display	Explanation
	Name	
①		Return to the previous screen.
	Return key	
②		Change the size of the character patterns. To change the size of one character, press to display and then select the character. The size of the selected character is changed.
	Size key	
③		Change the layout of the character patterns. <ul style="list-style-type: none"> To arrange the character patterns on an arc, press , , or . : Make the arc flatter. : Make the arc rounder. To arrange the character patterns on an incline, press . : Change the incline counterclockwise. : Change the incline clockwise. : Reset the layout.
	Array key	
④		Change the spacing of the character patterns. <ul style="list-style-type: none"> : Increase the character spacing. : Decrease the character spacing. To change the spacing after one character, press to display and then select the character. The spacing between the selected character and the next character is changed. ABCD E ↔ ABCDE ABCDE ↔ ABCDE : Move the one selected character up. : Move the one selected character down. : Reset the spacing.
	Character spacing key	

No.	Display	Explanation
	Name	
⑤		Switch alignment. This function is available when multiple lines of characters are input. <ul style="list-style-type: none"> : Right alignment : Left alignment : Center alignment
	Alignment key	
⑥		Change the font of the characters. Depending on the font that was selected, it may not be possible to change the font. <ul style="list-style-type: none"> To change the font of one character, press to display and then select the character. The font of the selected character is changed.
	Font Type key	
⑦		Apply the character pattern editing.
⑧		Enter a space.
	Space key	
⑨		Make a new line.
⑩		Delete the character.
	Delete key	
⑪		Select the category of character.
⑫		Select to edit all characters or one character. <ul style="list-style-type: none"> : Edit all characters. : Edit one character.
	Select one/all key	
⑬		Move the cursor and select a character.
	Character selection keys	

Selecting Frame Patterns

- 1 Press .
- 2 Press the key of the frame shape you want to embroider in the top part of the screen.
→ Various frame patterns are displayed at the bottom part of the screen.

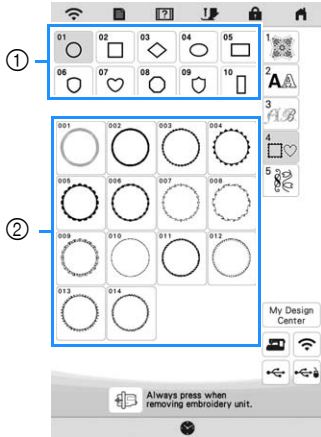

- ① Frame shapes
- ② Frame patterns

- 3 Press the key of the frame pattern you want to embroider.
→ The selected pattern is displayed on the screen.
- 4 Press .
- 5 Follow the steps from 4 to 7 of “Selecting Embroidery Patterns” on page 109.

Combining Patterns

Example:



- 1 Select a pattern and then press .

- 2 Press .

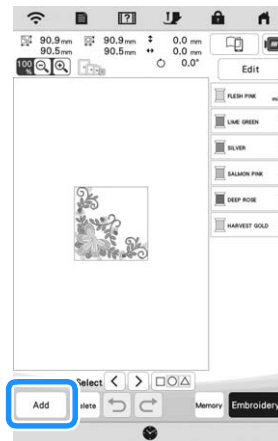

- 3 Press .

- 4 Select  and enter “LOVE”.

→ The characters you enter will be displayed in the center of the embroidery pattern area.

- 5 Press .

- 6 Press  and then press .

- 7 Use  to move the characters.

* Characters can also be moved by directly dragging them with your finger or the touch pen.

8 Press **OK**.

9 Press  to change the color of the characters. (page 122)



10 Press **OK**.



11 When all editing is finished, press **Embroidery**.

Note

- Combined patterns will be embroidered in the order they were entered.

Selecting a Pattern

If multiple patterns have been combined, use

Select   to select the pattern to be edited. Patterns can also be selected by directly touching the screen with your finger or touch pen.

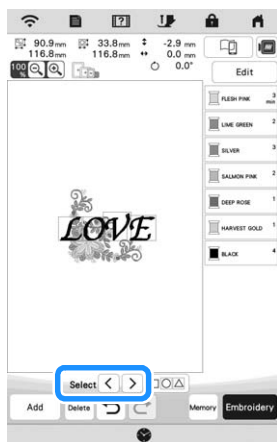

Selecting Multiple Patterns at the Same Time



Multiple patterns can easily be edited, for example, when moving patterns, if they are all selected together.

1 Press .

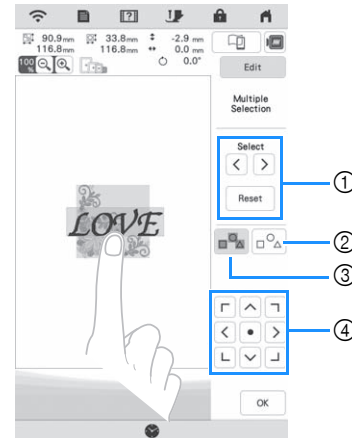

2 Touch each pattern to be selected.



- 1 Press  or  to check the patterns to be selected, and then press **Set**. The selected patterns are highlighted with a red box. To deselect the selected patterns, press **Reset**.
- 2 Press this key to deselect all selected patterns.
- 3 Press this key to select all patterns in the pattern display area.
- 4 Patterns can be moved with this key.

Memo

- You can also select multiple patterns by dragging your finger to specify the area of selection.

3 Press **OK** to return to the edit screen.

→ Each selected pattern is surrounded with a red box.

Memo

- The following functions are available while multiple patterns are selected.
 - Copying
 - Grouping
 - Stipling
 - Extracting pattern outlines

■ Grouping Patterns

If the multiple patterns are grouped, they can be edited as a single pattern.

1 Select patterns you want to group. (page 113)

2 Press .

→ The selected patterns are grouped.

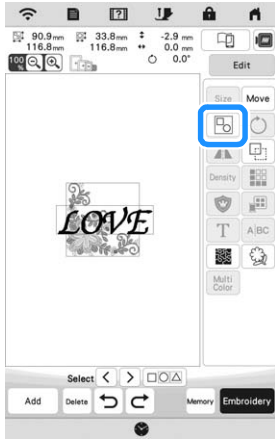

* To ungroup a grouped pattern, select the grouped pattern, and then press . At this time, multiple patterns are selected. To cancel the multiple selection, press any other pattern or the blank area.

Memo

- The following functions are applied to all patterns in the grouped pattern.
 - Moving
 - Rotating
 - Appliqué
 - Border
 - Extracting pattern outlines
 - Simple stippling
 - Thread color changing

EDITING PATTERNS

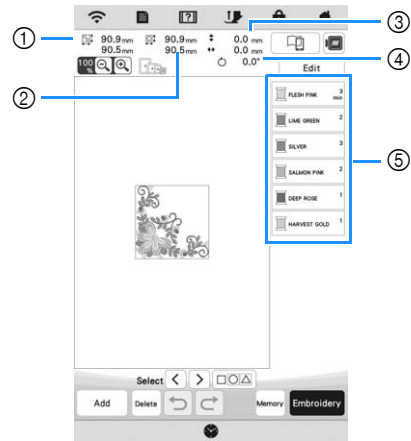

- ① Size of the entire combined pattern
- ② Size of the pattern currently selected
- ③ Distance from the center of the frame to the center of the pattern currently selected
- ④ Degree of rotation for the pattern currently selected
- ⑤ Color sequence and stitching times of each step of the pattern

■ Key Functions





Using these keys, you can edit the selected pattern. Press

 to display the editing window.

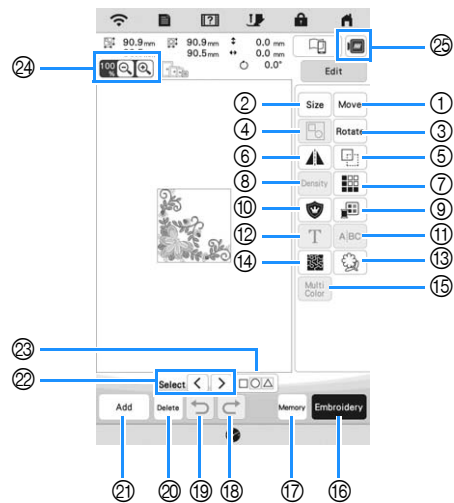
Memo

- If a key display is grayed out, you cannot use that function with the selected pattern.



No.	Display	Explanation	Page
	Name		
①		Display the pattern moving window.	112
	Move key		
	 <ul style="list-style-type: none"> •  : Move the pattern in the direction shown by the arrow. •  : Center the pattern. 		

No.	Display Name	Explanation	Page
②	Size	Display the pattern sizing window. • : Decrease the pattern proportionately. • : Decrease the pattern vertically. • : Decrease the pattern horizontally. • : Enlarge the pattern proportionately. • : Stretch the pattern vertically. • : Stretch the pattern horizontally. • : Change the size of the character patterns. • : Reset the size. (except for character patterns.) • : Move the pattern in the direction shown by the arrow.	117
	Size key		
③	Rotate	Display the pattern rotating window. • : Reset the position. • : Move the pattern in the direction shown by the arrow. You can also rotate the pattern by dragging the red point at the corners of the pattern.	—
	Rotate key		
④		Group selected multiple patterns.	114
	Group key		
⑤		Duplicate the pattern.	—
	Duplicate key		
⑥		Change the pattern to a horizontal mirror image.	—
	Horizontal mirror image key		
⑦		Make and edit the repeated pattern.	117
	Border key		
⑧	Density	Change thread density for some alphabet character and frame patterns. Other patterns are available after enabling patterns to change the density.	117
	Density key		
⑨		Change the thread color.	123
	Thread palette key		
⑩		Create an appliqué outline of the pattern.	141
	Appliqué key		

No.	Display Name	Explanation	Page
⑪	A BC	Separate the continuous character patterns to adjust the spacing or edit separately afterwards. • : Select where the patterns is to be separated. • : Separate the patten. A separated character pattern cannot be combined again.	—
	Separate key		
⑫	T	Edit characters.	111, 116
	Letter Edit key		
⑬		Extract the outline of the pattern. The extracted pattern can be used with My Design Center.	171
	Outline key		
⑭		Create stippling around the pattern.	—
	Stippling key		
⑮	Multi Color	Press this key when you want to change the thread color, character by character in character embroidery. Since the machine stops at the end of each character, the upper thread can be changed as you embroider.	—
	Multi color key		
⑯	Embroidery	Proceed to the embroidery screen.	—
	Embroidery key		
⑰	Memory	Save a pattern in the machine's memory or USB media. The pattern can also be transferred to a computer via a wireless network connection.	150
	Memory key		
⑱		Redo the last operation that was undone.	—
	Redo key		
⑲		Undo the last operation.	—
	Undo key		
⑳	Delete	Delete the selected pattern (the pattern outlined by the red box).	—
	Delete key		
㉑	Add	Add another pattern to the editing pattern.	112
	Add key		
㉒	Select < >	Select the pattern to edit when there are multiple patterns.	113
	Pattern select key		
㉓		Make multiple patterns to be selected at the same time.	113
	Multiple selection key		
㉔	100%	• : Magnify the image. Use to scroll through the display in any direction. • : Demagnify the image (minimum: 100%). • : Select the percent of magnification.	—
	Magnify keys		
㉕		Preview the embroidery image.	116
	Image key		

■ Editing Letters



For details on input keys, refer to “Character Pattern Input Keys” on page 111.

Memo

- To edit character patterns with multiple lines in the edit screen, ungroup the pattern. (page 114)

Previewing the Pattern

1 Press .



→ An image of the pattern as it will be embroidered appears.

2 Press to select the frame used in the preview.

* Frames displayed in gray cannot be selected.

* Press to enlarge the image of the pattern.

* The pattern can be embroidered as it appears in the display.



3 Press to check the embroidering order.

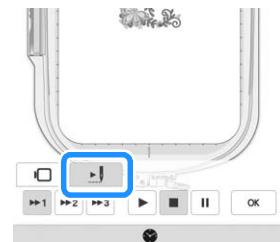

→ The stitch simulator screen appears.

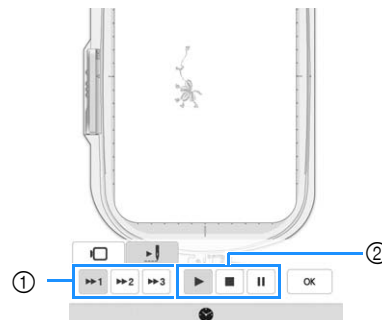

- ① Simulation speed keys
- ② Operation keys
 - : Start the simulation at the set speed.
 - : Pause the simulation.
 - : Stop the simulation.

* Press to return to the embroidery frame selection screen.

4 Press .

Changing the Size and the Density of the Pattern

If  is selected, you can change the pattern size while maintaining the thread density. The machine recalculates the stitch density automatically. With this function, the pattern will be enlarged or reduced at a larger ratio than with normal pattern resizing.



Note

- This function cannot be used with alphabet character patterns, frame patterns, repeated patterns or buttonhole patterns.
- Patterns with a large number of stitches (100,001 or more) cannot be resized while maintaining a thread density.

Memo



- Depending on the pattern, the size of the pattern increases up to 200% or reduces to 60%.
- You can also change the size by dragging the red point at the sides and corners of the pattern.

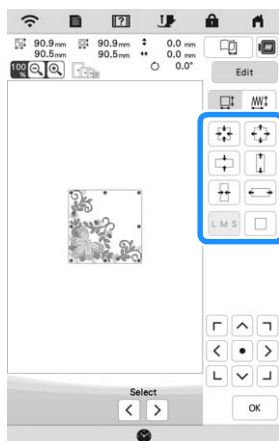

1 Select   in the size window.

- * : Change the pattern size while maintaining the number of stitches. The thread density for the pattern increases or decreases.
- * : Change the pattern size while maintaining the thread density. After the pattern size is changed, the thread density can be changed in the edit screen. The number of stitches is recalculated depending on the pattern size.

2 Select the direction in which to change the pattern size.





3 When you select  in step 1, press , and then press  to change the thread density.

- * : Make the pattern less dense.
- * : Make the pattern more dense.

4 Press .





Creating Repeated Patterns

Using the border function, you can create repeated patterns. You can also adjust the spacing of the patterns.

1 Press , and then press .



2 Select the direction in which the pattern will be repeated.

- * : Repeat the pattern above.
- * : Repeat the pattern below.
- * : Delete above pattern.
- * : Delete below pattern.

Vertical direction 

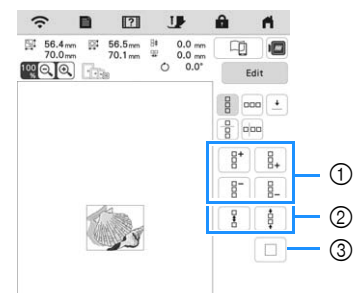

- ① Repeating and deleting keys
- ② Spacing keys
- ③ Key to cancel pattern repeating

Horizontal direction

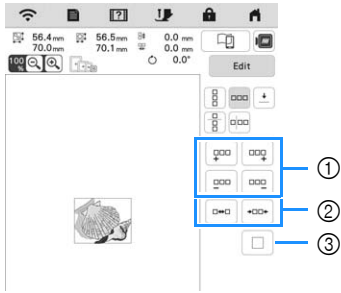

- ① Repeating and deleting keys
- ② Spacing keys
- ③ Key to cancel pattern repeating

3 Adjust the spacing of the repeated pattern.

- * : Widen spacing.
- * : Tighten spacing.

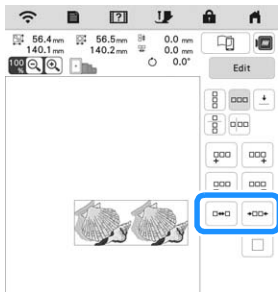

4 Complete repeated patterns by repeating steps 2 through 3.

5 Press **.**

Repeating One Element of a Repeated Pattern

You can select one element of a repeated pattern and repeat only that single element. This function allows you to create complex repeated patterns.

1 Press

2 Choose the direction in which the repeated pattern will be cut.

- * : Cut horizontally.
- * : Cut vertically.

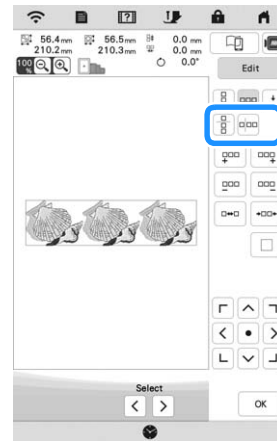

→ The pattern direction indicator will change depending on the direction selected.

3 Use **and** **to select the cut line.**

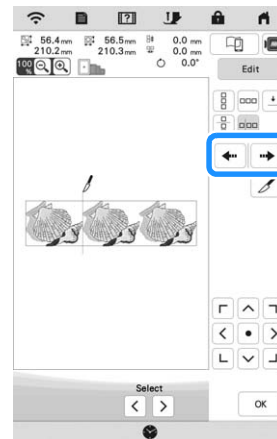

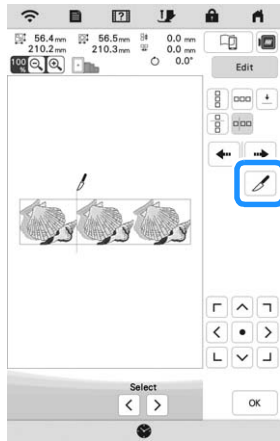

4 Press .



→ The repeated pattern will be divided into separate elements.

5 Press .

6 Use  and  to select the element to repeat.

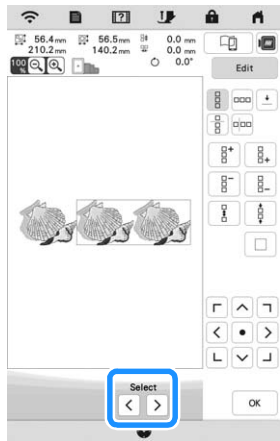

7 Repeat the selected element.

8 Press .

Color Sorting Repeated Patterns

Press **Embroidery** to automatically change the embroidering order of colors in combined border embroidery patterns so that the same color can be continuously embroidered. This allows you to continue embroidering without repeatedly changing the upper thread or changing the embroidering order manually.

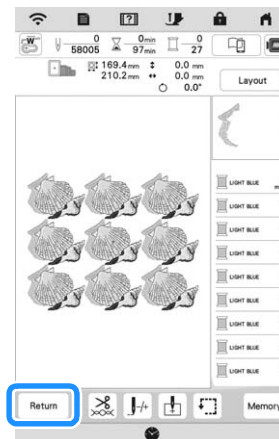
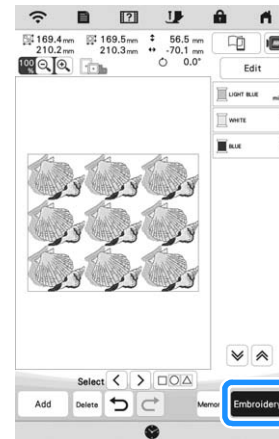

Memo

- When a grouped pattern is repeated, the embroidering order is changed in each pattern.
- If there are repeated patterns with other repeated patterns or other patterns, the embroidering order of only the repeated patterns is changed.

Assigning Thread Marks

By sewing thread marks, you can easily align patterns when rehooping the fabric to embroider a series. When embroidering is finished on a pattern, a thread mark in the shape of an arrow will be sewn using the final thread. When embroidering a series of patterns, use the point of this arrow for positioning the following designs to be embroidered.

1 Press .

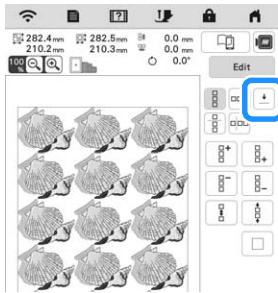

2 Press .

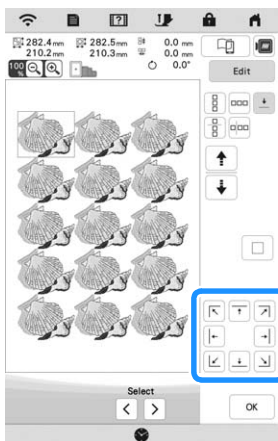

3 Press  to select the thread mark to be sewn.



 **Memo**

- When there are two or more elements, use  or  to select an element to assign a thread mark(s) to.

4 Press .

Embroidering the Pattern Repeatedly

After creating the repeated pattern, rehoop the embroidery frame and keep embroidering for the next pattern.

 **Memo**

- The optional border frame allows you to easily rehoop the fabric without removing the embroidering frame from the machine.

1 Select the repeated pattern and assign the thread mark at the center of the bottom of the pattern.

* Refer to “Assigning Thread Marks” on page 119.

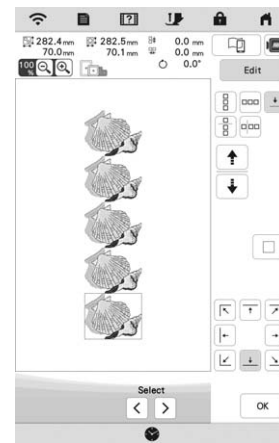

2 Press , then .

3 Press the “Start/Stop” button to start embroidering.

→ When embroidering is finished, the thread mark is embroidered with the last thread color.

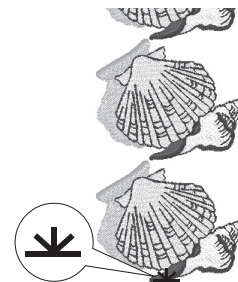

4 Remove the embroidery frame.

5 Rehoop the fabric in the embroidery frame.

 **Note**

- Adjust the position of the fabric so that the embroidering area for the next pattern is within the embroidering area of the embroidery sheet.

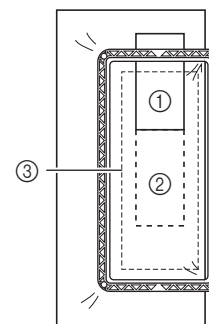

- ① Pattern embroidered first
- ② Position of pattern to be embroidered next
- ③ Embroidering area of embroidery sheet

6 Attach the embroidery frame to the machine, and then

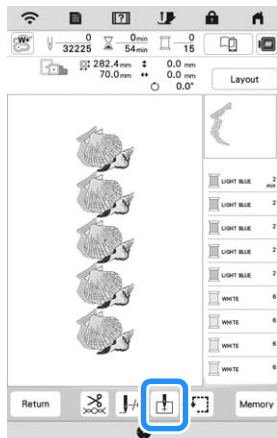

press .



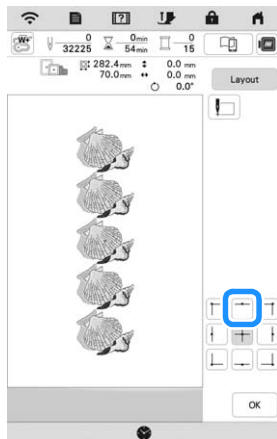

7 Press  to set the starting point to the center top of the pattern.

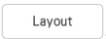

8 Press .

9 Press , and then press .

10 Press  to move the embroidery frame until the thread mark on the fabric is aligned with the light of the LED pointer.

* To check the needle drop point with the light of the LED pointer, press .

 **Memo**

- For the accurate needle drop point, slowly turn the handwheel toward you (counterclockwise) to lower the needle. Then, turn the handwheel away from you (clockwise) until the mark on the handwheel is at the top. The carriage cannot move if the mark on the handwheel is not at the top.

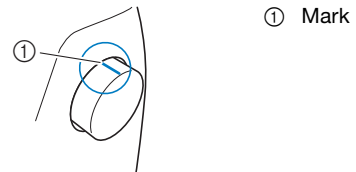

11 Press .

12 Remove the thread mark.

13 Start embroidering.

EDITING COLORS

Changing the Thread Color



You can change the thread color from the thread colors assigned by the machine.

- 1 Press **Edit**, and then press .



→ The thread color palette appears.

- 2 Press the color of the part to be changed.

* Press  or  to display the thread color that is not on the screen.

→ The selected thread color image appears.

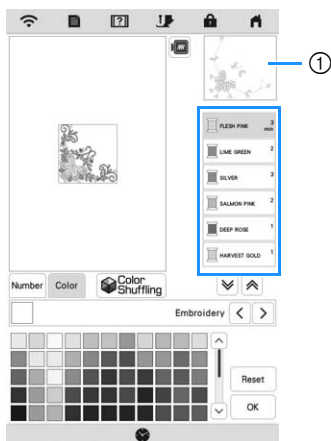

- 1 Selected thread color image

Memo

- When you directly touch a part of the pattern whose color is to be changed, the part can be selected and displayed.

- 3 Select a new color from the thread color palette, and then press **OK**.

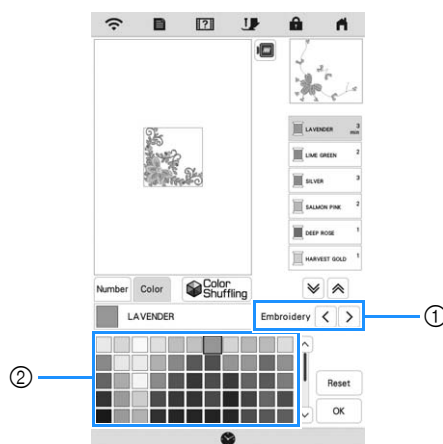

- 1 Thread brand for colors

- 2 Thread color palette

→ The display shows the changed colors.

* To return to the original color, press **Reset**. If multiple colors have been changed, this command will return all colors to their original colors.

Memo

- Press **Number** to specify a thread color by entering its number. If you enter the wrong number, press **C**, and then enter the correct number. After entering the number, press **OK**.



Finding New Color Schemes with the Color Shuffling Function

With the color shuffling function, the machine suggests new color schemes for the embroidery pattern that you have selected. After you select the effect ([Random], [Vivid], [Gradient] or [Soft]), sample color schemes for the selected effect are displayed.

1 Press **Edit**, and then press .

2 Press .



Note

- This function may not be available depending on the pattern you select (ex. a repeated pattern, licensed pattern).

3 Select the thread brand for colors and the number of colors you want to create the pattern with.

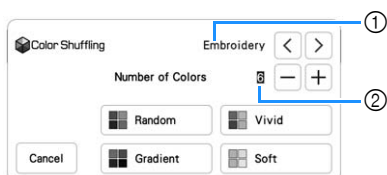

- ① Thread brand for colors
- ② Number of colors to be used

4 Select the desired effect.



- ① Effects for schemes
- If you select [Random] or [Gradient], the color specifying screen will appear.
- If you select [Vivid] or [Soft], proceed to step 7.

5 Press **Auto** **Manual** to set **Manual** and specify the thread color to use in the effect.

- * If you don't need to specify the thread color, just set to **Auto**.

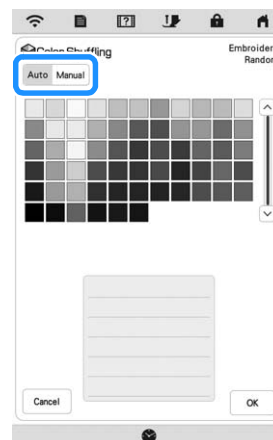

[Manual] setting for [Random]

You can select up to 6 colors to be used in the [Random] effect. The effect will be created using the selected colors.



- ① Select colors from the palette.
- ② Selected colors are listed.

[Manual] setting for [Gradient]

You can select one color to be used in the [Gradient] effect. The effect will be created with a color you select.

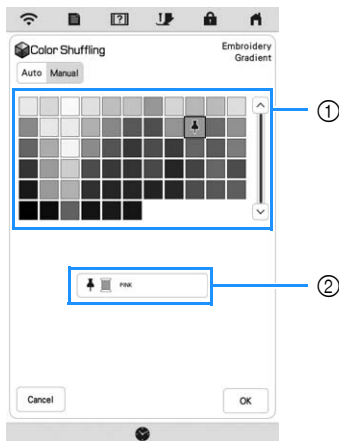

- ① Select a color from the palette.
- ② Selected color is displayed.

6 Press **OK**.

7 Select the color scheme from samples.

* Press **Refresh** to add the new schemes.

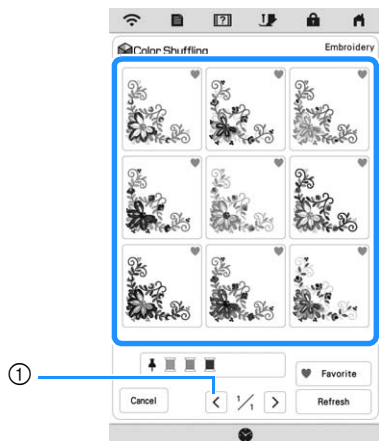

① Press to review the previous schemes.

Memo

- To temporarily register your favorite schemes, press **♥** (to release your favorite schemes, press **♥** again). 9 color schemes can be added. Press **♥ Favorite** to check the registered favorite schemes.

To cancel the registration, press **✕**.

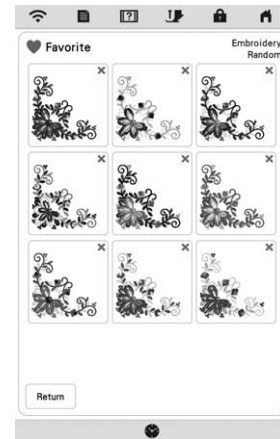

Note

- Maximum 20 pages of schemes can be reviewed.

8 Select the displayed color scheme.

- * **Cancel** : Return to the previous screen.
- * **<** or **>** : Display the other color schemes.
- * **Set** : Select the displayed color scheme.



→ The thread color palette screen will appear.

Thread Color Sorting

This function allows you to embroider while replacing the thread spool a minimal number of times.

Before starting to embroider, press **☰** in the embroidery screen to rearrange the embroidery order and sort it by thread colors.

- 1 Press **Layout** in the embroidery screen.

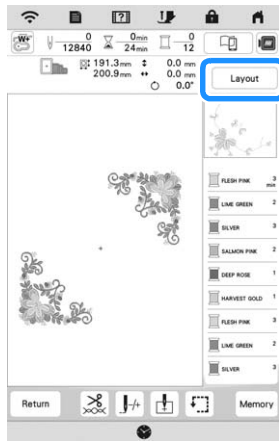

- 2 Press .

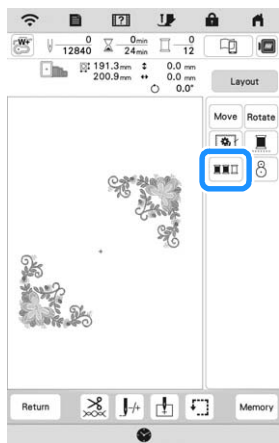

- * Press **Layout** again to check the sorted thread colors.

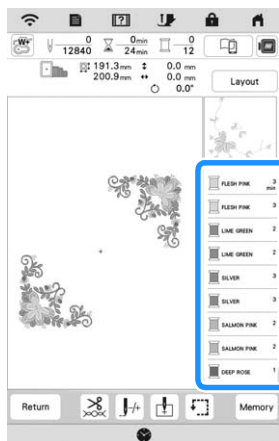

→ The embroidery color order is rearranged and sorted by thread colors.

- * Press **Layout**, then  to cancel color sorting and embroider with the original embroidery color order.

Note

- This function does not work on overlapping patterns.

VIEWING THE EMBROIDERY SCREEN

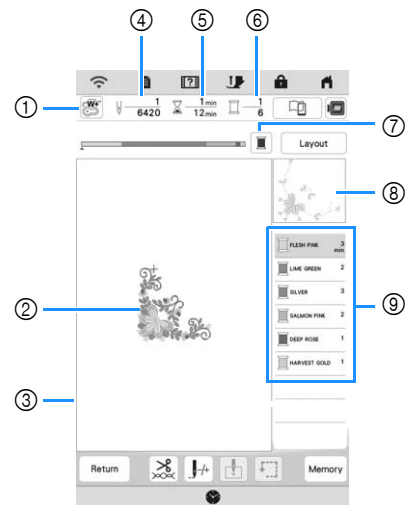

* This screen appears when embroidery starts.

- The presser foot symbol
Attach embroidery foot "W+" with LED pointer or embroidery foot "W" (sold separately) for all embroidery projects.
 - A preview of the pattern
 - The boundary for embroidering with the selected frame in the settings screen
 - Total number of stitches in the selected pattern and number of stitches that have already been embroidered
 - The time necessary to embroider the pattern, and the time already spent embroidering the pattern (not including time for changing and automatically trimming the thread)
 - The number of colors in the pattern, and the number of the color currently being embroidered
 - Switch the progress bar (which shows the embroidering progress) between showing only one color or all colors. This key appears after starting embroidering or after pressing the  key.
 - The part of the embroidery pattern that will be embroidered with the thread color at the top of the list
 - The order for thread color changes and the embroidering time for each thread color
- * The displayed time is the approximate time that will be required. The actual embroidering time may be longer than the displayed time, depending on the embroidery frame that is used.

Key Functions





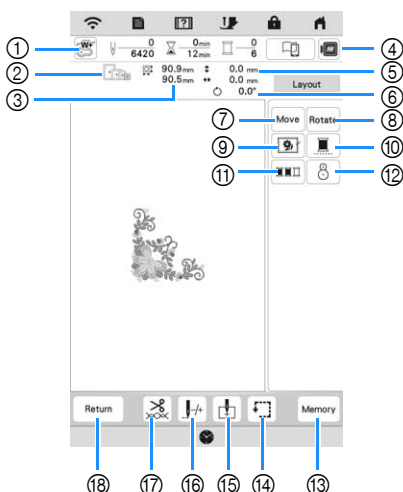

Using these keys, you can move or rotate pattern, etc.













Press  to display the editing window.

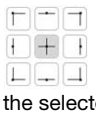

Note

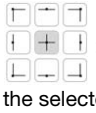
- Some operations or functions are not available for certain patterns. If the key display is grayed out, you cannot use that function or operation with the selected pattern.

No.	Display	Explanation	Page
	Name		
①		Turn on the light of the LED pointer.	131
	Needle point check key	Press this key to check the needle drop point with the light of the LED pointer.	
②		Shows the embroidery frames that can be used for the selected pattern. Be sure to use the proper frame.	128
	Available frames		
③	90.9 mm 90.5 mm	Shows the size of the selected pattern.	—
	Pattern size		
④		Preview the embroidery image.	116
	Image key		
⑤	0.0 mm 0.0 mm	Shows the distance between the embroidering position and the center (when the embroidery pattern is moved).	—
	Distance		
⑥	 0.0°	Shows the degree of rotation of the pattern.	—
	Degree		
⑦		Display the pattern moving window.	—
	Move key		
⑧		Display the pattern rotating window.	—
	Rotate key		
⑨		Add the basting stitch around the pattern. You can select the distance from the pattern to the basting stitching.	29, 140
	Basting key		

No.	Display	Explanation	Page
	Name		
⑩		Change the setting to embroider the pattern with a single color. Press the key again to return to the original setting. Even if uninterrupted embroidering  has been set, the automatic thread cutting function and the thread trimming function can be used. The icons of the spool of thread are grayed out.	—
	Uninterrupted embroidery key		
⑪		Rearrange the embroidery order and sort it by thread colors.	124
	Thread color sorting key		
⑫		Press this key to align the embroidering position.	133
	Embroidery positioning key		
⑬		Save the pattern to the machine's memory or USB media. The pattern can also be transferred to a computer via a wireless network connection.	150
	Memory key		
⑭		Check the position of the pattern. <ul style="list-style-type: none"> •  : Move the carriage to trace the embroidery area of the pattern. This allows you to check that there is enough space to embroider the pattern. •  : Move the carriage to the selected position. 	133
	Trial key		
⑮		Specify the needle start position. <ul style="list-style-type: none"> •  : Set the needle start position to the lower-left corner of the pattern. This setting is useful when connecting patterns since it allows you to continue embroidering until the first stitch of the next pattern. •  : Move the carriage to the selected position. 	147, 148
	Starting point key		
⑯		Move the needle forward or back in the pattern; useful if the thread breaks while embroidering or if you want to start again from the beginning.	138
	Forward/Back key		
⑰		Set automatic thread cutting, thread trimming or the thread tension. For embroidery, these functions are set automatically.	143-146
	Cut/Tension key		
⑱		Return to the edit screen.	—
	Return key		



PREPARING THE FABRIC

⚠ CAUTION

- Use fabrics with a thickness of less than 3 mm (approx. 1/8 inch). Using fabrics thicker than 3 mm (approx. 1/8 inch) may cause the needle to break.

💡 Note

- When using layers with thicker batting etc., you can embroider more attractive finishes by adjusting the embroidery presser foot height in the embroidery settings screen.

Press , and use  and  in the [Embroidery Foot Height] in the embroidery settings screen. Adjust the presser foot height for thick or puffy fabrics.



- To increase the space between the embroidery foot and the right side of the fabric, set the [Embroidery Foot Height] to a larger number.
- In the case of thick terry cloth towels, we recommend that you place a piece of water soluble stabilizer on the top surface of the towel. This will help to reduce the nap of the toweling and result in more attractive embroidery.

Attaching Iron-on Stabilizers (Backing) to the Fabric

⚠ CAUTION

- Always use a stabilizer material for embroidery when embroidering on stretch fabrics, lightweight fabrics, fabrics with a coarse weave, or fabrics which cause pattern shrinkage. Otherwise, the needle may break and cause injury.

1 Iron the iron-on stabilizer material to the wrong side of the fabric.

- Use a piece of stabilizer which is larger than the embroidery frame being used.

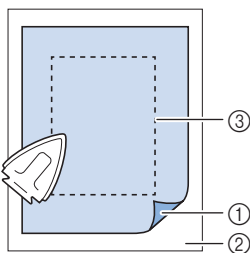

- ① Fusible side of stabilizer
- ② Fabric (wrong side)
- ③ Size of the embroidery frame

📖 Memo

- When embroidering small pieces of fabric that cannot be hooped in an embroidery frame, use stabilizer material as a base. After lightly ironing the fabric to the stabilizer material, hoop it in the embroidery frame. If stabilizer material cannot be ironed onto the fabric, attach it with a basting stitch. After completing the embroidery, remove the stabilizer material carefully.

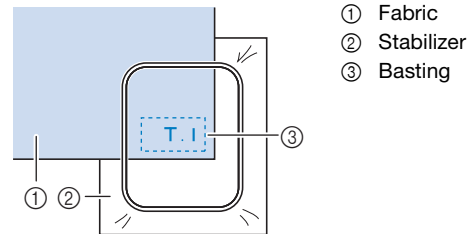

- When embroidering on thin fabrics such as organdy or lawn, or on napped fabrics such as towel or corduroy, use water soluble stabilizer (sold separately) for best results. The water soluble stabilizer material will dissolve completely in water, giving the project a more attractive finish.

Hooping the Fabric in the Embroidery Frame

Types of Embroidery Frames

Optional embroidery frames can be used. When choosing frames that do not appear on the screen, be sure to check the design size of the embroidery field of the optional frame. Check with your authorized Brother dealer for frame compatibility.

Select a frame that matches the pattern size. Available frame options are displayed on the LCD.

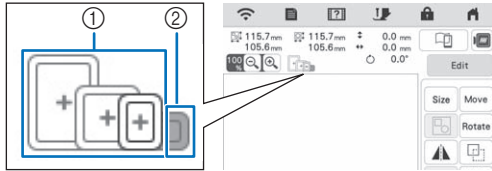

- ① Highlighted: Can be used
- ② Shaded: Cannot be used

Inserting the Fabric

Note

- If the fabric is not securely held in the embroidery frame, the pattern will embroider out poorly. Insert the fabric on a level surface, and gently stretch the fabric taut in the frame.
- Embroidery frames with factory-coded stickers can be used with the application (My Design Snap).

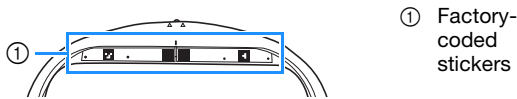

- ① Factory-coded stickers

- 1 Lift-up and loosen the frame adjustment screw and remove the inner frame.

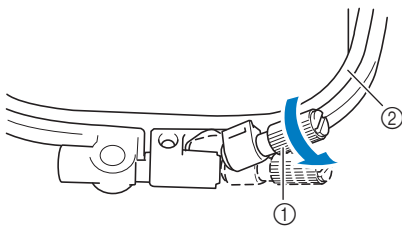

- ① Frame adjustment screw
- ② Inner frame

- 2 Lay the fabric right side up on top of the outer frame.

- 3 Insert the inner frame making sure to align the inner frame's \triangle with the outer frame's ∇ .

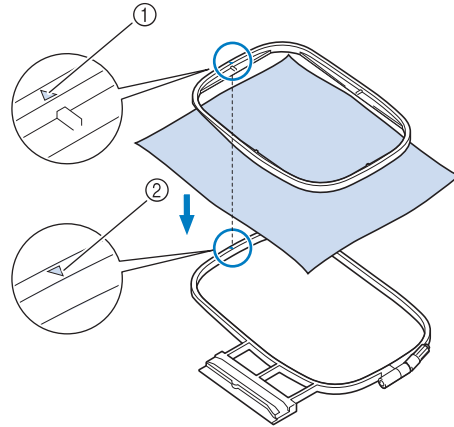

- ① Inner frame's \triangle
- ② Outer frame's ∇

- 4 Slightly tighten the frame adjustment screw.

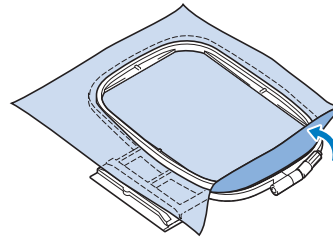

- 5 Gently smooth out the fabric. Make sure fabric is flat and without wrinkles.

- * After stretching the fabric, make sure the fabric is taut.

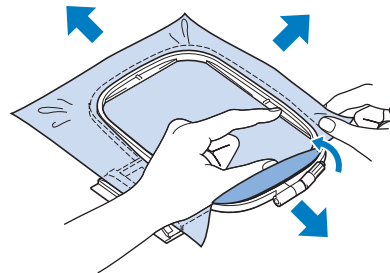

- * Make sure the inside and outside frames are even before you start embroidering.

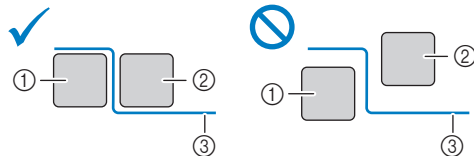

- ① Outer frame
- ② Inner frame
- ③ Fabric

- 6** Tighten the frame adjustment screw to keep the fabric from loosening while stitching.

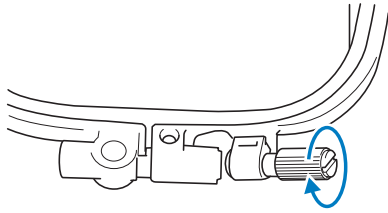

- 7** Return the frame adjustment screw to its initial position.

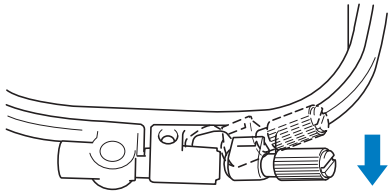

Memo

- You can use the disc-shaped screw driver, when you loosen or tighten the frame adjustment screw.

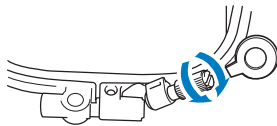

Using the Embroidery Sheet

When you want to embroider the pattern in a particular place, use the embroidery sheet with the frame.

- 1** With a chalk pencil, mark the area of the fabric you want to embroider.

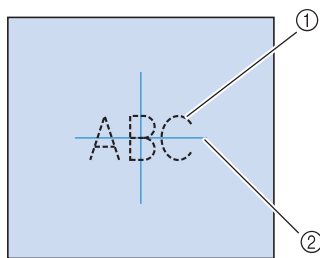

- ① Embroidery pattern
- ② Mark

- 2** Place the embroidery sheet on the inner frame. Align the guide lines on the embroidery sheet with the mark you made on the fabric.

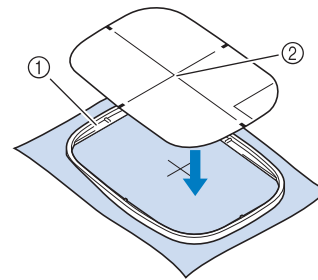

- ① Inner frame
- ② Guide line

- 3** Gently stretch the fabric so there are no folds or wrinkles, and press the inner frame into the outer frame.

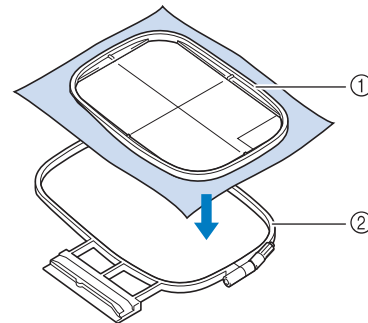

- ① Inner frame
- ② Outer frame

- 4** Remove the embroidery sheet.

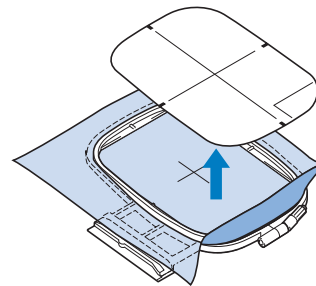

ATTACHING THE EMBROIDERY FRAME



Note

- Wind embroidery bobbin thread and insert the bobbin before attaching the embroidery frame. Check that there is enough thread in the bobbin.

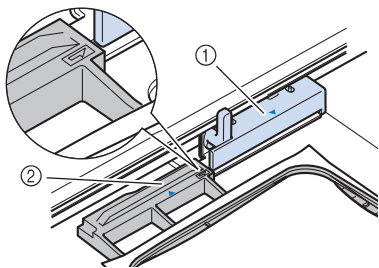
- 1 Press  (Presser foot lifter button) to raise the presser foot.
- 2 Align the embroidery frame guide with the right edge of the embroidery frame holder.



- ① Embroidery frame holder
- ② Embroidery frame guide

- 3 Slide the embroidery frame into the holder, making sure to align the embroidery frame's  with the holder's .

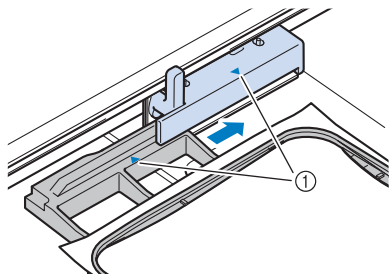

- ① Arrow mark

- 4 Lower the frame-securing lever to be level with the frame to secure the embroidery frame in the embroidery frame holder.

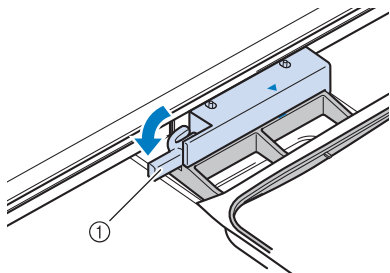

- ① Frame-securing lever

Removing the Embroidery Frame

- 1 Press  (Presser foot lifter button) to raise the presser foot.
- 2 Raise the frame-securing lever.

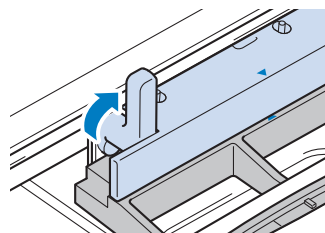

- 3 Pull the embroidery frame toward you.

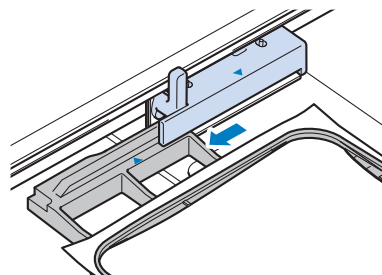

CONFIRMING THE PATTERN POSITION

The pattern is normally positioned in the center of the embroidery frame. If the pattern needs to be repositioned for better placement on the garment, you can check the layout before starting embroidery.



Checking the Needle Drop Point with the Embroidery Foot “W+” with LED Pointer

1 Press  in the embroidery screen.

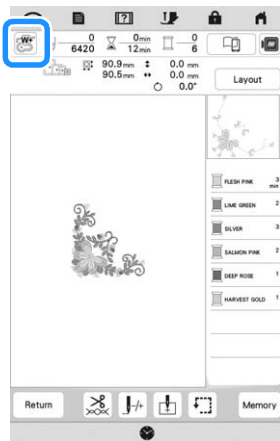
→ The LED pointer indicates the needle drop point.



Memo

- When the LED pointer turns on, the presser foot height is automatically adjusted according to the fabric thickness.
-  appears when the embroidery foot “W+” with LED pointer is attached to the machine.
- If  is not displayed, you cannot use the LED pointer.
- The LED pointer turns off automatically by lowering the presser foot or returning to the previous page.

Note

- With spongy fabric, the position may not be accurate due to the various depths of the fabric.
- With fabric that has a very uneven surface such as quilting, the fabric thickness may not be correctly measured. In this case, the pointer indication should be used only as a reference.

Adjusting the LED Pointer

Adjust the LED pointer if it indicates a point different than the actual needle drop point. Before adjusting the LED pointer, mark the actual needle drop point on the fabric to be embroidered, and attach the embroidery frame.

1 Press .

→ The settings screen appears.

2 Press .

→ The embroidery settings screen appears.

3 Display [Embroidery Foot with LED Pointer Adjustment] in the embroidery setting screen.

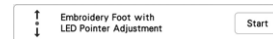

Note

- As a default,  appears gray. After the embroidery foot “W+” with LED pointer is attached to the machine, the key becomes available and settings can be specified.

4 Press .



→ The Embroidery Foot “W+” with LED Pointer Adjustment screen appears.



① LED pointer adjustment

Note

- The specified setting is saved in the machine's memory. This is useful for positioning during continuous embroidering.
- For normal use, return the setting to [00].

5 Use  or  to adjust the LED pointer so that it indicates the actual needle drop point.



Memo

- In order to more accurately check the needle drop point, turn the handwheel toward you (counterclockwise) to lower the needle.

6 Press  to return to the original screen.

Adjusting the Brightness of the LED Pointer

1 Follow the steps from ① to ③ of “Adjusting the LED Pointer” on page 131 to display the embroidery foot with LED pointer adjustment screen.

2 Use  or  to adjust the brightness of the LED pointer.

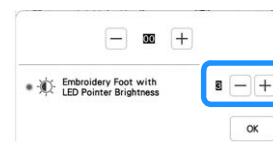

3 Press  to return to the original screen.

Displaying a Background Image

Using a special application downloaded to a smartphone or tablet, you can transfer a photo of the hooped fabric to be embroidered to the machine to be used as a background image.

The embroidery frame is displayed in the application. You can see how the pattern will be arranged on the actual fabric.

Note

- The wireless network settings must first be specified on the machine. Refer to “WIRELESS NETWORK CONNECTION FUNCTIONS” on page 33.
- Embroidery frames with factory-coded stickers can be used with the application (My Design Snap).

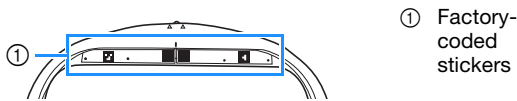

■ Displaying the Background Image on the Screen of the Machine

- 1 Select the pattern. (page 108)
- 2 Photograph the fabric in the frame with the easy mode of the application, and then transfer it to the machine.
For a detailed procedure, refer to the application.

- 3 Press .
* Attach the frame used in the image before pressing .

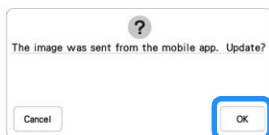

→ The transferred background image appears on the screen of the machine.

Memo

- To hide the background image, press .
Press to display the background image again.
- The transferred background image includes the embroidery frame display.

■ Calibrating the Position of the Background Image

By calibrating the position of the background image transferred to the machine, the pattern can be positioned more accurately.

- 1 Select a pattern. (page 108)
- 2 Set the application to advanced mode, attach the embroidery positioning sticker to the fabric in the hoop, take the photo of the background, and with the advanced mode of the application, transfer it to the machine.

For a detailed procedure, refer to the application.

- 3 Press .
* Attach the frame used in the image before pressing .

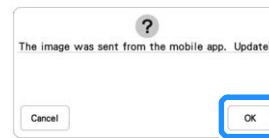

→ The carriage will move, and the LED pointer will turn on.

- 4 Use to align the LED pointer with the center of the larger circle in the embroidery positioning sticker.

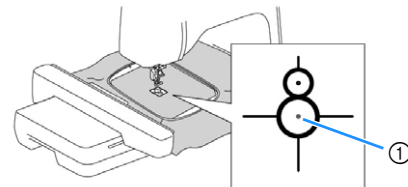

- ① Center of the larger circle in the embroidery positioning sticker

Memo

- The position can also be calibrated by lowering the needle with the handwheel. This method enables more accurate positioning. Slowly turn the handwheel toward you (counterclockwise) to check the needle drop point. Then, turn the handwheel away from you (clockwise) until the mark on the handwheel is at the top. The carriage cannot move if the mark on the handwheel is not at the top.

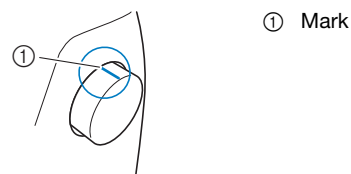

- 5 Press .

→ The position of the background image is calibrated.

Aligning the Embroidering Position

- 1 Calibrate the position of the background image. (page 132)
- 2 Press .

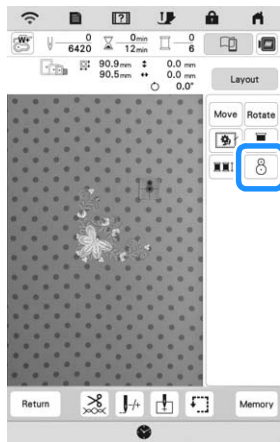

Memo

- The orientation of the pattern will change depending on the orientation of the embroidery positioning sticker.

- 3 When the following message appears, press .

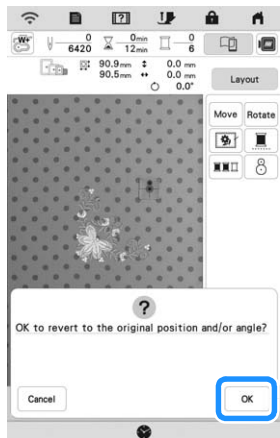

- 4 Select the position to be set as the reference point.





- 5 Press .

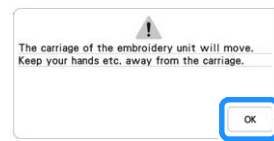

→ When the following message appears, press .



- 6 Remove the embroidery positioning sticker, and then start embroidering.

* To remove the embroidery positioning sticker more easily, press  so that the embroidery frame moves slightly forward and away from under the needle. After the embroidery positioning sticker is removed, press .



Checking the Pattern Position

The carriage moves and shows the pattern position. Watch the embroidery frame closely to make sure the pattern will be embroidered in the right place.

- 1 Press .

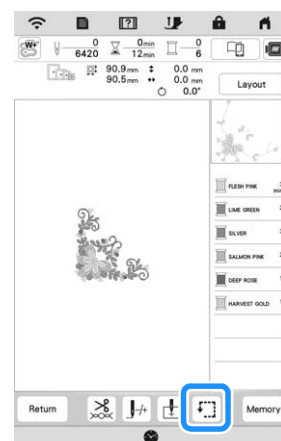

- 2 From , press the key for the position that you want to check.

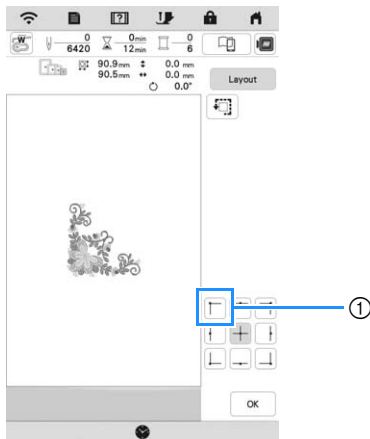

- ① Selected position
 → The carriage will move to the selected position on the pattern.

Memo

- To see the entire embroidering area, press . The carriage moves and shows the embroidery area.

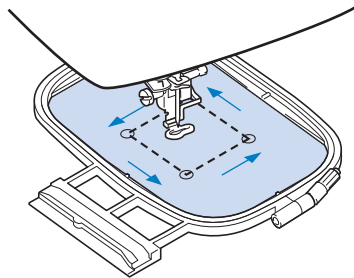

CAUTION

- Make sure the needle is up when the carriage is moving. If the needle is down, it could break and result in injury.

- 3 Press .

EMBROIDERING A PATTERN

Embroidering Attractive Finishes

Many factors are involved in achieving a beautiful embroidery result. Using the appropriate stabilizer (page 127) and hooping the fabric in the frame (page 128) are two important factors mentioned earlier. Another important point is the appropriateness of the needle and thread being used. See the explanation of threads below. Included with this machine are two bobbin cases. Follow the explanation below.

Thread	Upper thread	Use embroidery thread intended for use with this machine.
	Bobbin thread	Use embroidery bobbin thread intended for use with this machine.

Memo

- If you use threads other than those listed above, the embroidery may not embroider out correctly.

Bobbin case (recommended for sewing and for embroidering with included 60 weight bobbin thread)

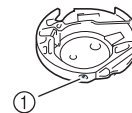

- ① Standard bobbin case (green marking on the screw)

Standard bobbin case originally installed in the machine has a green marking on the screw. We recommend using the included embroidery bobbin thread with this bobbin case. Do not adjust the tension screw on this bobbin case with the green marked screw.

Bobbin case (for prewound or other embroidery bobbin threads)

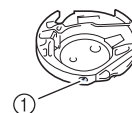

- ① Bobbin case (no color on the screw)

The bobbin case with no color on the screw is set with tighter tension for embroidery with different weights of bobbin threads and a variety of embroidery techniques. This bobbin case is identified with a dark colored mark on the inside of the bobbin cavity. The tension screw on this case can be adjusted if necessary. For details, refer to "Adjusting the Alternate Bobbin Case (with No Color on the Screw)" on page 145.

⚠ CAUTION

- When embroidering on large garments (especially jackets or other heavy fabrics), do not let the fabric hang over the table. Otherwise, the embroidery unit cannot move freely and the embroidery frame may strike the needle, causing the needle to bend or break and possibly cause injury. Place the fabric so that it does not hang off the table or hold the fabric to keep it from dragging.

■ Embroidery Needle Plate Cover

Under some conditions, based on the type of fabric, stabilizer, or thread being used, there may be some looping in the upper thread. In this case, attach the included embroidery needle plate cover to the needle plate. Attach the cover by inserting the two projections on the underside of the cover into the notches on the needle plate as shown below.

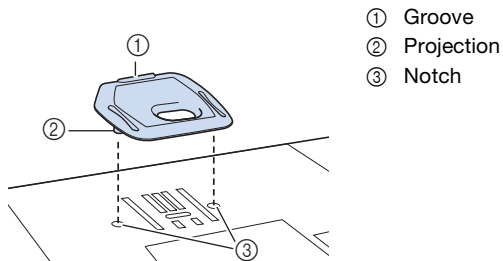

To remove the embroidery needle plate cover, place your fingernail in the groove and lift the plate out.

⚠ CAUTION

- Push the embroidery needle plate cover as far as possible to attach it. If the embroidery needle plate cover is not securely attached, it may cause the needle to break.

Embroidering Patterns

- Prepare embroidery threads of the colors shown on the screen.

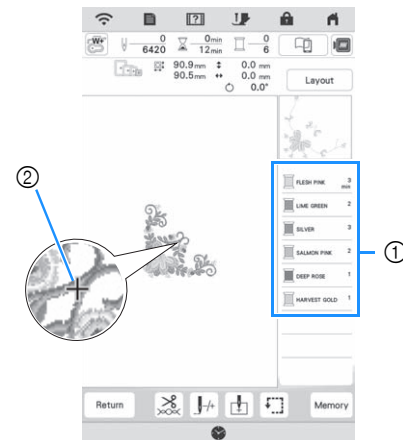

- Embroidery color order
- Cursor

📖 Memo

- The [+]
cursor moves over the pattern, showing which part of the pattern is being embroidered.

- Using the automatic needle threader, thread the machine for the first color. (page 42)

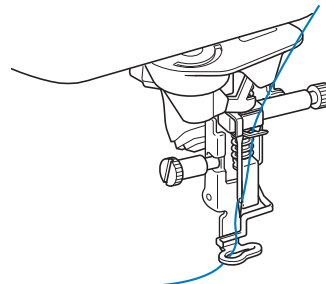

- Lower the presser foot, then press the "Start/Stop" button to start embroidering.

→ When the first color is completely embroidered, the machine will automatically trim the threads and stop. The presser foot will then automatically be raised. On the embroidery color order display, the next color will move to the top.

Memo

- If you want to get more attractive finishes, try the procedures below;
 - After 5-6 stitches, press the “Start/Stop” button again to stop the machine.
 - Trim the excess thread at the beginning of the pattern. If the excess thread tail is under the embroidery foot, raise the embroidery foot, then trim the excess thread.

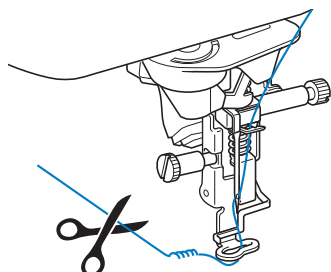

- If there is thread left over from the beginning of embroidering, it may be embroidered over as you continue embroidering the pattern, making it very difficult to deal with the thread after the pattern is finished. Trim the threads at the beginning of each thread change.

4 Remove the upper thread for the first color from the machine. Thread the machine with the next color.

5 Repeat the same steps for embroidering the remaining colors.

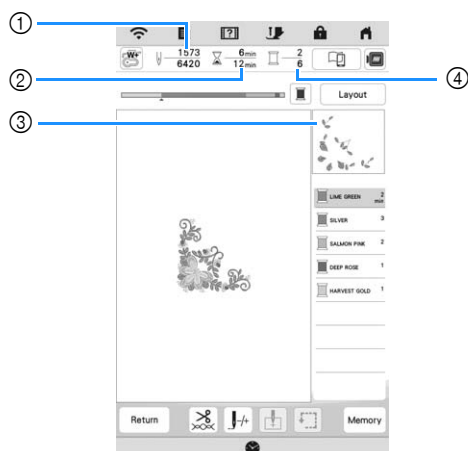



- ① Current stitch numbers/Total stitch numbers
 - ② Current time/Total time
 - ③ Part of pattern to be embroidered next
 - ④ Embroidered colors/Total colors
- When the last color is embroidered, [Finished embroidering] will appear on the display. Press , and the display will return to the original screen.

Memo

- The thread trimming function is originally set to trim excess thread jumps (threads linking parts of the pattern, etc.). Depending on the type of thread and fabric that are used, an end of upper thread may remain on the surface of the fabric at the beginning of the stitching. After embroidering is finished, cut off this excess thread.
If the setting has been turned off, trim the excess thread jumps using scissors after the pattern is finished. Refer to page 146 for information on the thread trimming function.

Using Appliqués

When the color embroidering order display shows

- [ (APPLIQUE MATERIAL)],
- [ (APPLIQUE POSITION)] or
- [ (APPLIQUE)], follow the procedure below.

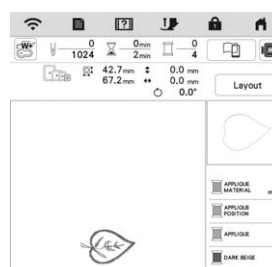

Required materials

- Fabric for the appliqué piece
- Fabric for the appliqué base
- Stabilizer material
- Fabric glue or temporary spray adhesive
- Embroidery thread

Note

- The correct names and numbers of the thread colors to be used will not appear. Use the thread colors depending on those in the appliqué pattern.

1. Creating an Appliqué Piece

- 1** Attach stabilizer material to the wrong side of the fabric for the appliqué piece.
- 2** Sew the cutting line of the appliqué piece. Remove the fabric for the appliqué piece from the embroidery frame, and then carefully cut along the sewn cutting line.



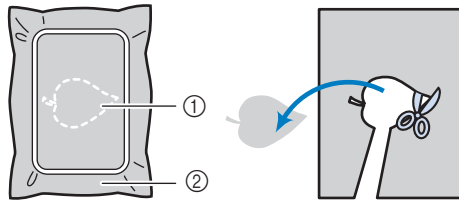

- ① Outline of appliqué
② Fabric for appliqué piece

Note

- If the appliqué piece is cut out along the inside of the cutting line, it may not be correctly attached to the fabric. Therefore, carefully cut out the appliqué piece along the cutting line.
- After cutting out the appliqué piece, carefully remove the thread.

2. Sewing the Appliqué Position on the Base Fabric

- 1 Attach stabilizer material to the wrong side of the fabric for the appliqué base.
- 2 Sew the appliqué position.

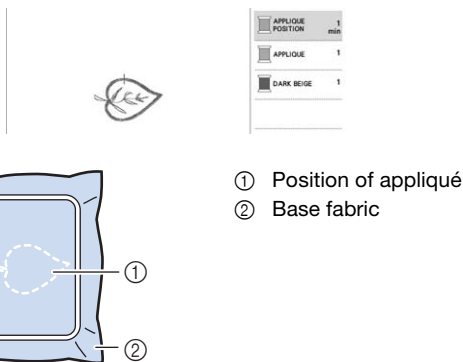

- 3 Remove the embroidery frame from the embroidery unit.

Note

- Do not remove the base fabric from the embroidery frame until all embroidering is finished.

3. Affixing the Appliqué Piece to the Base Fabric

- 1 Lightly apply fabric glue or temporary spray adhesive to the back of the appliqué piece, and then attach it to the base fabric within the outline of the position sewn in step 2 of "2. Sewing the Appliqué Position on the Base Fabric".

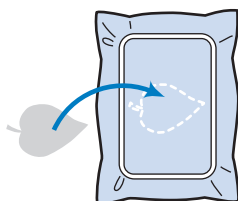

Note

- If the appliqué piece cannot be attached to the base fabric with fabric glue or temporary spray adhesive, securely baste it in place with basting stitches.
- If thin fabric is used for the appliqué piece, reinforce and secure it in place with an iron-on adhesive sheet. An iron can be used to attach the appliqué piece to the appliqué location.

- 2 After the appliqué piece is attached, attach the embroidery frame to the machine. Thread the machine with the embroidery thread, lower the presser foot lever, and then press the "Start/Stop" button to embroider the appliqué.

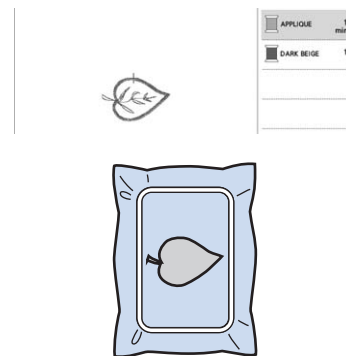

4. Embroidering the Remainder of the Pattern

- 1 Change the embroidery thread according to the embroidery color order display, and then finish embroidering the remainder of the pattern.

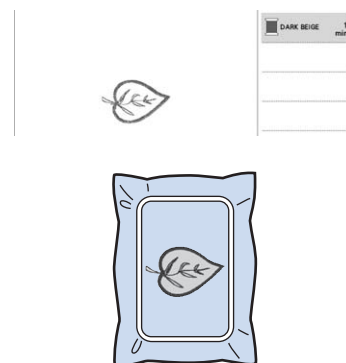

Memo

- Since glue may become attached to the presser foot, needle or needle plate, clean off any glue after finishing embroidering the appliqué pattern.
- For best results, trim all excess threads each time the thread color is changed.

ADJUSTMENTS DURING THE EMBROIDERY PROCESS

If the Thread Breaks or the Bobbin Runs out of Thread During Embroidering

1 Redo the upper threading or replace the bobbin.

If the upper thread breaks, stop the machine, trim the bobbin thread, and then rethread the machine.



If the bobbin thread is almost empty or broken, press



of the displayed message, remove the embroidery frame, and then replace the bobbin.



Note

- If [Upper and Bobbin Thread Sensor] in the settings screen of the machine is set to [OFF], the message shown above does not appear.

2 Press .

3 Press , or to move the needle back the correct number of stitches before the area where the thread broke, and then press .







- Press  to restart from the beginning.



Note

- It is recommended to stitch over the top of the last two or three stitches for complete coverage.

Memo

- If you cannot move back to the spot where the thread broke, press  or  to select the color and move to the beginning position of that color, then use , , , or  to move ahead to slightly before where the thread broke.

4 Lower the presser foot and press the "Start/Stop" button to continue embroidering.

Resuming Embroidery after Turning off the Power

The current color and stitch number are saved when embroidery is stopped. The next time the machine is turned on, you have the option to continue or delete the pattern.





Chapter **5**
Advanced Embroidery

VARIOUS EMBROIDERING FUNCTIONS



Basting Embroidery

Before embroidering, basting stitches can be sewn along the outline of the pattern. This is useful for embroidering fabric that cannot have stabilizer material affixed with an iron or adhesive. Basting stitches can be used to attach material that cannot be hooped to stabilizer, making it possible to be embroidered.

Note

- It is recommended to finish combining and editing the pattern before selecting the basting setting. If the pattern is edited after selecting the basting setting, the basting and pattern may become misaligned, and the basting under the pattern may be difficult to remove after embroidering is complete.

1 Press .



2 Use  and  to specify the distance from the pattern to the basting stitching.



Memo

- The higher the setting, the farther the basting is from the pattern.
- The setting remains selected even if the machine is turned off.

3 Press  to return to the embroidering screen.

4 Press , and then press  to select the basting setting.



Note

- When  is pressed, the pattern is moved to the center. After selecting the basting setting, move the pattern to the desired position.

→ Basting is added to the beginning of the embroidering order.

5 Press the "Start/Stop" button to start embroidering.

6 When embroidering is finished, remove the basting stitching.

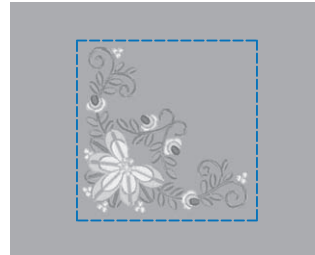

Creating an Appliqué Piece

Creating an appliqué piece is convenient for fabrics that cannot be embroidered or when you wish to attach an appliqué to a garment.

Creating an Appliqué Piece

The following pattern will be used to create an appliqué piece.



Note

- Felt or denim fabrics are recommended to make the appliqué piece. Depending on the pattern and fabric used, lighter weight fabrics may cause the stitching to appear smaller.
- For best results, be sure to use stabilizer material for embroidering.
- When making appliqué pieces, do not use the optional border embroidery frame. Depending on the pattern density and fabric used, shrinkage of the stitching may occur.

1 Select the pattern, and edit it if necessary.

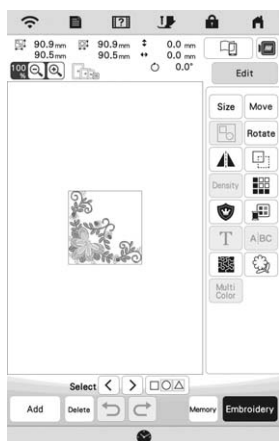

Note

- Finish combining and editing the pattern before selecting the appliqué setting. If the pattern is edited after selecting the appliqué setting, the appliqué stitching and pattern may become misaligned.
- Since an outline is added, the pattern for an appliqué piece (when the appliqué setting is selected) will be larger than the original pattern. First, adjust the size and position of the pattern as shown below.

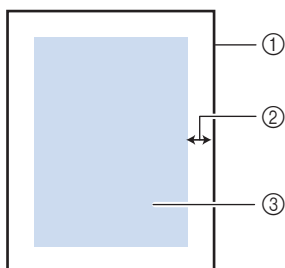

- ① Embroidering area
- ② About 1cm (1/2 inch)
- ③ Pattern size

2 Press to display the settings screen.

3 Use and to specify the distance from the pattern to the appliqué outline.



4 Press .

5 Press and then, press to position the satin stitching around design.

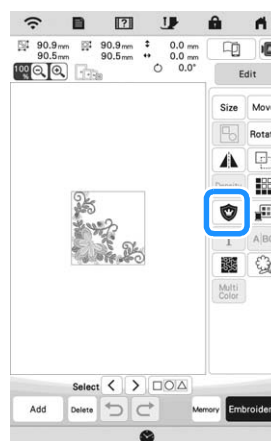

Note

- When is pressed, the pattern is moved to the center. After selecting the appliqué setting, move the pattern to the desired position.

→ The steps for creating the appliqué piece are added to the embroidering order.

Memo

- The appliqué setting is applied only to the selected pattern. To select multiple patterns, refer to “Selecting Multiple Patterns at the Same Time” on page 113.
- Three steps are added to the embroidering order: appliqué cutting line, position of pattern placement on the stabilizer material, and appliqué stitching.

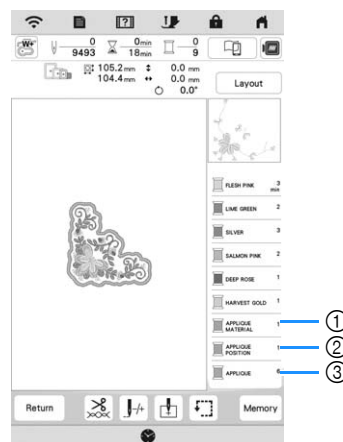

- ① Cutting line for appliqué
- ② Position of pattern placement on stabilizer material
- ③ Appliqué stitching

Note

- An appliqué piece cannot be created if the pattern is too large or too complicated or a combined pattern is separated. Even if the selected pattern fits within the embroidering area, the entire appliqué pattern may exceed the embroidering area when the outline is added. If an error message appears, select a different pattern or edit it.

- 6 Fuse or stick a piece of stabilizer to the back of the felt or denim fabric to be used as the appliqué piece.
- 7 Hoop the fabric for the appliqué piece in the embroidery frame, attach the embroidery frame to the machine, and then start embroidering.
- 8 After the pattern is embroidered, thread the machine with the thread for the cutting line, and then sew the cutting line (APPLIQUE MATERIAL).

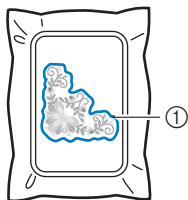

① Cutting line for appliqué

Memo

- We recommend using thread for the cutting line that is closest to the color of the fabric.

- 9 Remove the fabric for the appliqué piece from the embroidery frame, and then carefully cut along the stitching. After cutting, carefully remove all of the cutting line thread.

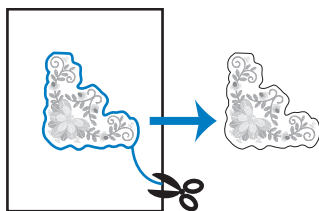

Note

- Depending on the pattern density and fabric used, there may be shrinking of the pattern, or the appliqué may be misaligned with the placement line. We recommend cutting slightly outside of the cutting line. Do not cut inside the cutting line, otherwise the appliqué fabric will not be caught by the appliqué stitch.
- When using patterns that are vertically and horizontally symmetrical, use a chalk pencil to indicate the pattern orientation before cutting it out.

- 10 Use two layers of adhesive water soluble stabilizer material with their sticky sides together, and then hoop them in the embroidery frame.

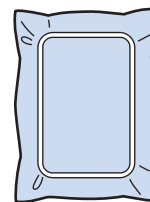

Note

- If water soluble stabilizer is used, it is not necessary to remove the stabilizer material after sewing the appliqué outline. To reduce shrinkage of the pattern, we recommend using water soluble stabilizer.
- Put together two layers of water soluble stabilizer, otherwise the stabilizer material may tear during embroidering.

- 11 Thread the machine with the thread for the outline, and then sew the placement line for the appliqué position (APPLIQUE POSITION).

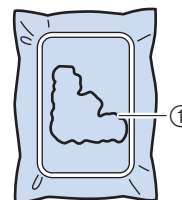

① Pattern placement line

- 12 Use two-sided stabilizer material, and paste the appliqué piece so that it aligns with the placement line.

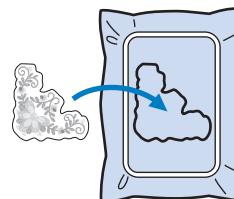

- 13 With the machine threaded using the thread for the outline from step 11, embroider the outline (APPLIQUE).

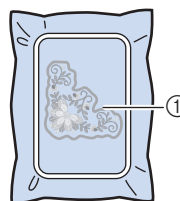

① Outline of appliqué piece

- 14 After embroidering is finished, remove the stabilizer material from the embroidery frame.

Note

- Since glue may become attached to the presser foot, needle or needle plate, clean off any glue after finishing embroidering the appliqué pattern.

- 15 Use scissors to cut the excess water soluble stabilizer from outside the appliqué outline.
- 16 Soak the appliqué piece in water to dissolve the water soluble stabilizer.

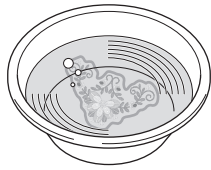

- 17 Dry the appliqué piece, and then iron it if necessary.

Note

- Do not apply a strong force when ironing, otherwise the stitching may be damaged.

MAKING EMBROIDERY ADJUSTMENTS

Adjusting Thread Tension

When embroidering, the thread tension should be set so that the upper thread can slightly be seen on the wrong side of the fabric.

The following screen appears when you press .

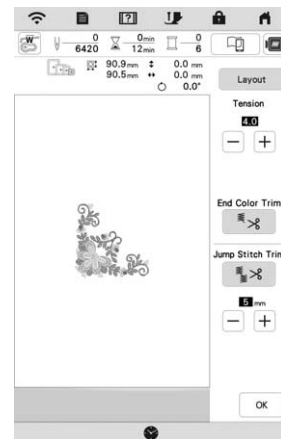
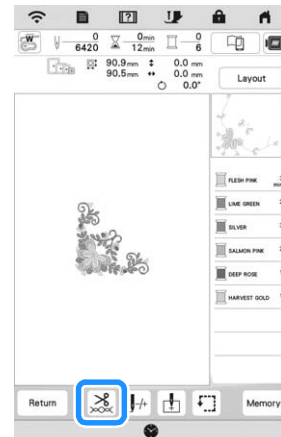

■ Correct Thread Tension

The pattern can be seen from the wrong side of the fabric. If the thread tension is not set correctly, the pattern will not finish well. The fabric may pucker or the thread may break.

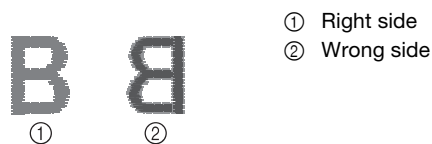

- ① Right side
- ② Wrong side

Follow the operations described below to adjust thread tension according to the situation.

Note

- If the thread tension setting is made extremely weak, the machine may stop during embroidering. This is not the sign of a malfunction. Increase the thread tension slightly, and start embroidering again.

Memo

- If you turn the main power to OFF or select a different pattern, the thread tension will reset to the automatic setting.

■ Upper Thread Is Too Tight

The tension of the upper thread is too tight, resulting in the bobbin thread being visible from the right side of the fabric.

Note

- If the bobbin thread was incorrectly threaded, the upper thread may be too tight. In this case, refer to “Setting the Bobbin” on page 40 and rethread the bobbin thread.



- ① Right side
- ② Wrong side

Press **-** in **Tension** to weaken the upper thread tension. (The tension number will decrease.)

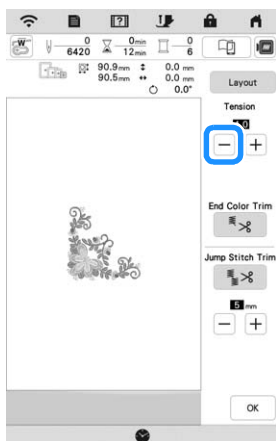

■ Upper Thread Is Too Loose

The tension of the upper thread is too loose, resulting in a loose upper thread, loose thread locks, or loops appearing on the right side of the fabric.

Note

- If the upper thread was incorrectly threaded, the upper thread may be too loose. In this case, refer to “Upper Threading” on page 42 and rethread the upper thread.

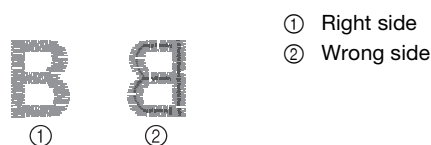

- ① Right side
- ② Wrong side

Press **+** in **Tension** to tighten the upper thread tension. (The tension number will increase.)

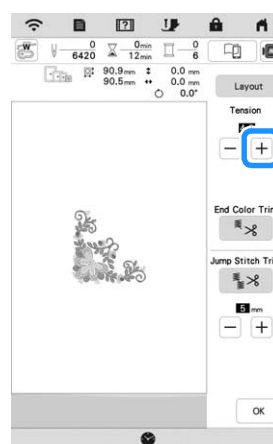

■ Adjusting Overall Upper Thread Tension

When embroidering, if the overall tension of the upper thread is too tight or too loose, adjust it from the setting screen. The selected setting will be applied to all patterns. If an individual embroidery pattern needs additional fine tuning, refer to “Adjusting Thread Tension” on page 143.

- 1 Press **☰**.
→ The settings screen appears.
- 2 Press **⏏**.
→ The embroidery settings screen appears.
- 3 Display [Embroidery Tension] in the embroidery settings screen.
- 4 Use **+** **-** to adjust the upper thread tension.
* **+** : Tighten the upper thread tension.
* **-** : Loosen the upper thread tension.
- 5 Press **OK**.



Adjusting the Alternate Bobbin Case (with No Color on the Screw)

When using the embroidery bobbin thread provided, please be sure to choose the green marked bobbin case when performing utility stitch sewing and embroidery functions. When in the embroidery function mode, the alternate bobbin case (with no color on the screw) should be selected when substitute embroidery bobbin threads (other than what is accompanied with your machine) are being used. The alternate bobbin case (with no color on the screw) can be easily adjusted when bobbin tension changes are required to accommodate different bobbin threads. Refer to "Embroidering Attractive Finishes" on page 134.

To adjust the bobbin tension for embroidery function, using the alternate bobbin case (with no color on the screw), turn the slotted screw (-) with a (small) screwdriver.

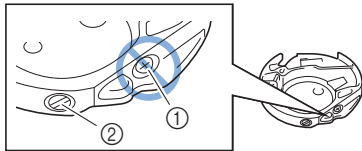

- ① Do not turn a phillips screw (+).
- ② Adjust with a screwdriver (small).

Correct Tension

Upper thread slightly appears on the wrong side of fabric.

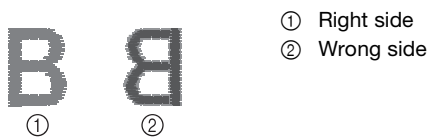

- ① Right side
- ② Wrong side

Bobbin Thread Is Too Loose

Bobbin thread appears slightly on the right side of fabric.



- ① Right side
- ② Wrong side

If this occurs, turn the slotted screw (-) clockwise, being careful not to over-tighten the screw, approximately 30-45 degrees to increase bobbin tension.

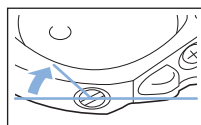

Bobbin Thread Is Too Tight

Upper thread on the right side of fabric seems to be lifting/looping and bobbin thread is not seen on the wrong side of fabric.



- ① Right side
- ② Wrong side

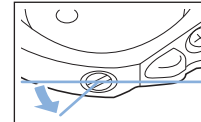

If this occurs, turn the slotted screw (-) counterclockwise, being careful not to over-loosen the screw, approximately 30-45 degrees to decrease bobbin tension.



CAUTION

- When adjusting the alternate bobbin case, be sure to remove the bobbin from the alternate bobbin case.
- DO NOT adjust the position of the phillips (+) screw on the alternate bobbin case as this may result in damage to the bobbin case, rendering it unusable.
- If the slotted screw (-) is difficult to turn, do not use force. Turning the screw too much or providing force in either (rotational) direction may cause damage to the bobbin case. Should damage occur, the bobbin case may not maintain proper tension.

Using the Automatic Thread Cutting Function (End Color Trim)

The automatic thread cutting function  will cut the thread at the end of embroidering each color. This function is initially turned ON. To turn this function OFF, press  and then .

* This setting returns to its default  when the machine is turned off.

1 Press .

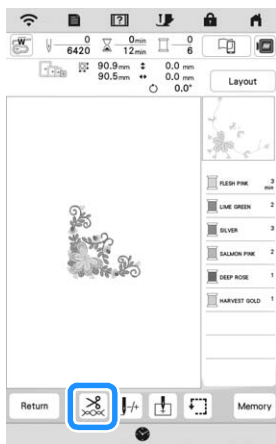

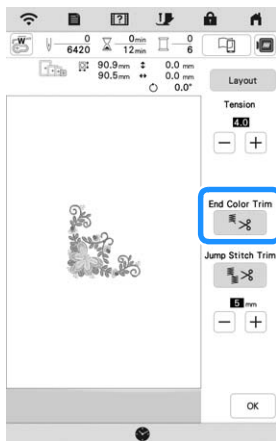

2 Press  to turn off the automatic thread cutting function.



→ The key will display as . When one color thread is embroidered, the machine will stop without cutting the thread.

Using the Thread Trimming Function (Jump Stitch Trim)

The thread trimming function  will automatically trim any excess thread jumps within the color. This function is initially turned ON. To turn this function OFF, press  key and then .

* Your customized setting remains after turning the machine off and on.

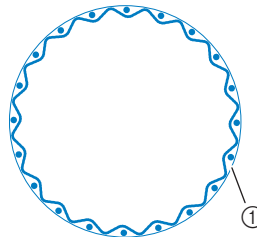

① Jump stitch

ABCDEF

①

1 Press .

2 Press  to turn off the thread trimming function.

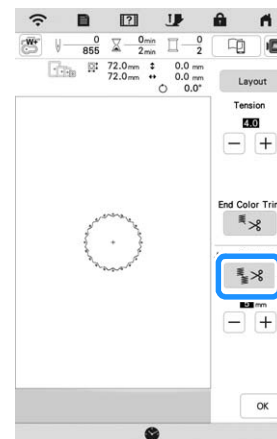

→ The key will display as . The machine will not trim the thread before moving to the next stitching.

■ Selecting the Length Of Jump Stitch Not to Trim

When the thread trimming function  is turned on, you can select the length of the jump stitch. Select a setting from 5 mm to 50 mm in 5 mm increments.

* Your customized setting remains after turning the machine off and on.

Press  or  to select the length of jump stitch.

For example: Press **+** to select 25 mm (1 inch) and the machine will not trim a jump stitch of 25 mm or less before moving to the next stitching.

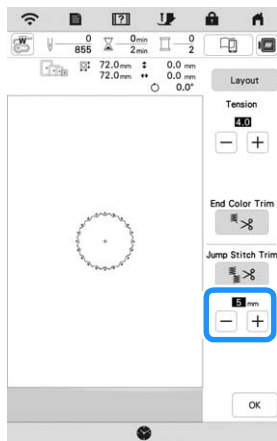

Note

- If design has many trims it is recommended to select a higher jump stitch trim setting in order to reduce the amount of excess tails on backside of fabric.
- The higher number of the jump stitch length selected, the fewer number of times the machine will trim. In this case, more jump stitches remain on the surface of the fabric.

Adjusting the Embroidery Speed

- 1 Press .
→ The settings screen appears.
- 2 Press .
→ The embroidery settings screen appears.
- 3 Display [Max Embroidery Speed] in the embroidery settings screen.
- 4 Use **+** **-** to change the maximum embroidery speed.



Memo

- SPM is the number of stitches embroidered in one minute.
- Decrease the embroidery speed when embroidering on thin, thick, or heavy fabrics and when using a speciality thread like a metallic thread.
- The setting specified before the main power is set to OFF remains selected the next time that the machine is turned ON.

Changing the Thread Color Display

You can display the name of the thread colors or embroidery thread number.

Memo

- Colors on the screen may vary slightly from actual spool colors.
- [Original], imported data remains the brand thread created with the software, is set as a default.

- 1 Press .
→ The settings screen appears.
- 2 Press .
→ The embroidery settings screen appears.
- 3 Display [Thread Color] in the embroidery settings screen.
- 4 Use **←** **→** to display the name of the thread colors or the embroidery thread number.

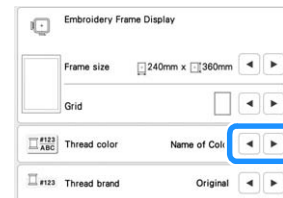

- 5 Use **←** **→** to select a thread brand.



Aligning the Pattern and the Needle

Example: Aligning the lower left side of a pattern and the needle

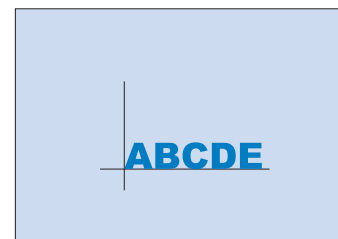

- 1 Mark the embroidery start position on the fabric, as shown.

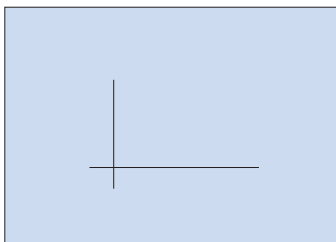

- 2 Press .



- 3 Press .

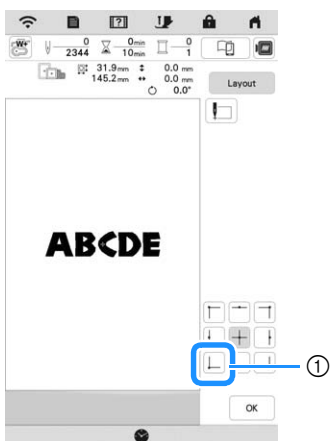

- ① Start position
 → The needle is positioned in the lower-left corner of the pattern. The carriage moves so that the needle is positioned correctly.

- 4 Press .

- 5 Press  and then, press .

- 6 Use  to align the needle and the mark on the fabric, and start embroidering the pattern.

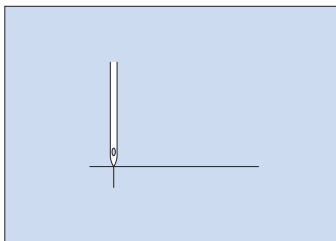

Embroidering Linked Characters

Follow the procedure described below to embroider linked characters in a single row when the entire pattern extends beyond the embroidery frame.

Example: Linking "FG" to the characters "ABCDE"

A B C D E F G

- 1 Select the character patterns for "ABCDE".

- 2 Press .



- 3 Press .

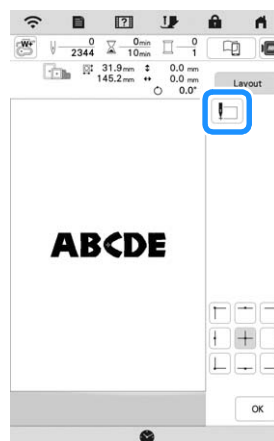

→ The needle is positioned in the lower-left corner of the pattern. The carriage moves so that the needle is positioned correctly. The machine is set to embroider until the first stitch of the next character pattern (F).

Note

- To cancel the starting point setting and return the starting point to the center of the pattern, press



- Using  can select a different starting point for embroidering. However, the starting point setting is canceled.

- 4 Press .

5 Press .



6 Press  to turn off the thread cutting function and then press .

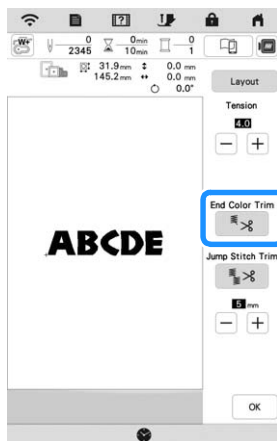

7 Start embroidering.

8 After the characters are embroidered, cut the threads to a generous length, remove the embroidery frame, reposition the fabric in the hoop so that the remaining characters ("FG") can be embroidered, and then attach the embroidery frame.

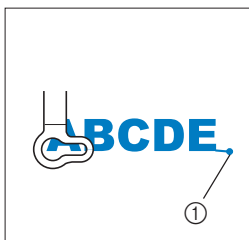

① End of the embroidering

9 As in step 1, select the character patterns for "FG".

10 Press .

11 Press .

→ The needle is positioned in the lower-left corner of the pattern. The carriage moves so that the needle is positioned correctly.

12 Press , then and use  to align the needle with the end of embroidering for the previous pattern.

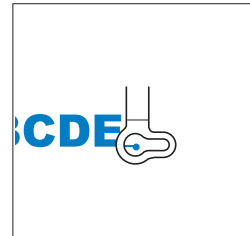

13 Press .

14 Press the "Start/Stop" button to start embroidering the remaining character patterns.



USING THE MEMORY FUNCTION

Saving Embroidery Patterns

Note

- Do not turn the main power to OFF while the [Saving...] screen is displayed. You will lose the pattern you are saving.
- Embroidery patterns cannot be transferred if the computer and machine are connected to different home networks. Be sure to connect to the same home network.

1 Press **Memory** when the pattern you want to save is in the embroidering screen.

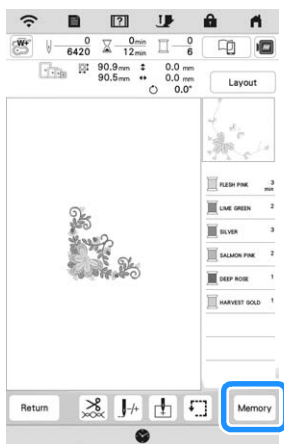

2 Press the desired destination to start saving.



- ① Save to the machine's memory.
- ② Save to the USB media. The pattern is saved in a folder labeled [bPocket]. When saving the embroidery pattern in a USB media, insert the USB media into the USB port on the machine.

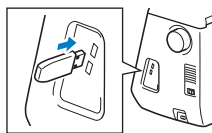

- ③ Save the pattern via the wireless network connection. For detailed procedures, refer to PE-DESIGN manual (Version 11 or higher).

Retrieving Embroidery Patterns

1 Press the desired destination, and then select the desired embroidery pattern.

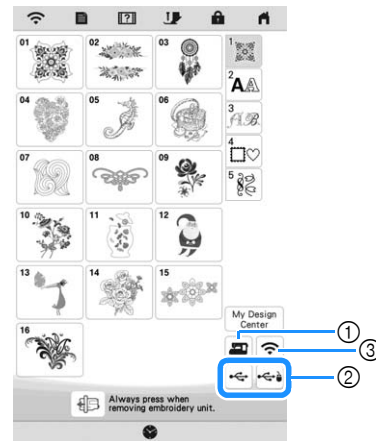

- ① Retrieve from the machine's memory.
- ② Retrieve from a USB media. When retrieving the embroidery patterns from a USB media, insert the USB media into the USB port on the machine.
- ③ Retrieve the pattern via the wireless network connection. For detailed procedures, refer to PE-DESIGN manual (Version 11 or higher).

Memo

- If the embroidery pattern to be retrieved is in a folder of the USB media, press the key for that folder. Press **Return** to return to the previous screen.
- You can save all or multiple data to the machine by pressing **Memory**.

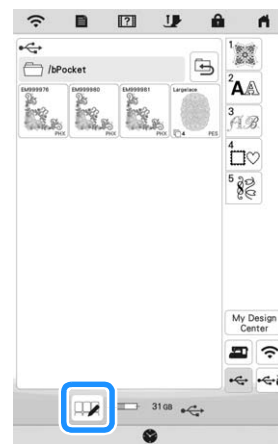

- To select multiple patterns, press their thumbnails.
- **Select all** : Select all patterns.
- **Select none** : Deselect all patterns.
- **Memory** : Save the selected patterns to the machine.
- * To cancel the selection, press **Return** again.

2 Press **Set**.

- * Press **Delete** to delete the embroidery pattern.

EMBROIDERY APPLICATIONS

Using a Frame Pattern To Make an Appliqué

Note

- If you change the size or position of the patterns when making an appliqué, make a note of the size and the location.

Method 1

You can use framed patterns of the same size and shape to create an appliqué. Embroider one pattern with a straight stitch and one pattern with a satin stitch.

- Select a straight stitch frame pattern. Embroider the pattern onto the fabric for the appliqué piece, then cut neatly around the outside of the shape.

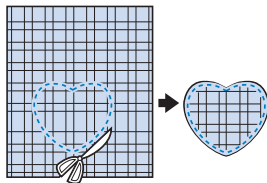
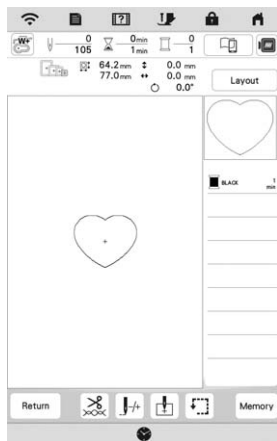

- Embroider the same pattern from step 1 onto the base fabric.
- Apply two-sided stabilizer material to the back of the fabric for the appliqué piece created in step 1. Attach the appliqué to the base fabric matching the shapes.

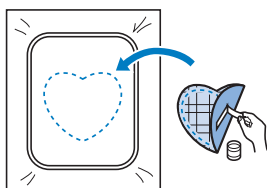

- Select the satin stitch frame pattern of the same shape as the appliqué. Embroider over the fabric for the appliqué piece and base fabric from step 3 to create the appliqué.

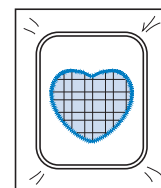
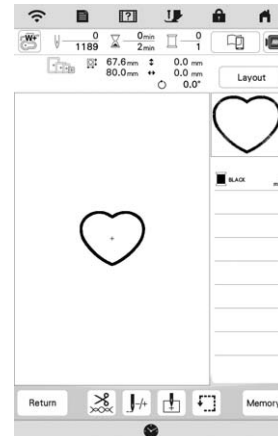
**Method 2**

- Select a straight stitch frame pattern, and embroider the pattern onto the base fabric.

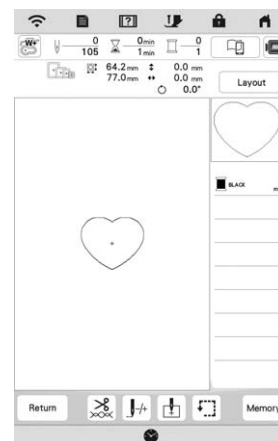

- Place the fabric for the appliqué piece over the pattern embroidered in step 1 and embroider the same pattern on the fabric for the appliqué piece.

* Be sure that the fabric for the appliqué piece completely covers the stitched line.

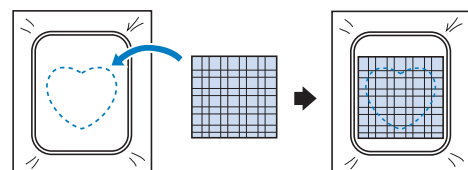

- Remove the embroidery frame from the embroidery unit, and cut around the outside of the stitches of the fabric for the appliqué piece. And then, reattach the embroidery frame to the embroidery unit.

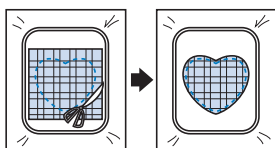

Note

- Do not remove the fabric from the embroidery frame to cut it. Also, do not pull or push on the fabric. Otherwise, the fabric may loosen in the frame.

- Select the satin stitch frame pattern of the same shape as the appliqué and embroider the satin stitch pattern to create an appliqué.

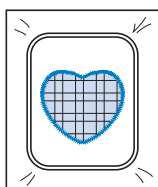
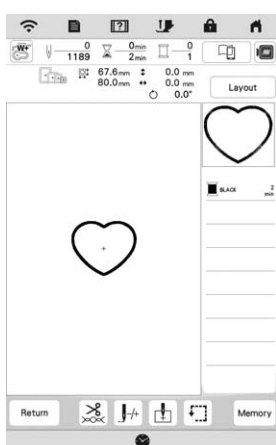

Embroidering Split Embroidery Patterns

Split embroidery patterns created with PE-DESIGN Ver. 7 or later, or PE-DESIGN NEXT can be embroidered. With split embroidery patterns, embroidery patterns larger than the embroidery frame are divided into multiple sections, which combine to create a single pattern after each section is embroidered.

For details on creating split embroidery patterns and for more detailed embroidery instructions, refer to the Instruction manual included with PE-DESIGN Ver. 7 or later, or PE-DESIGN NEXT.

- Insert the USB media containing the created split embroidery pattern, and then select the split embroidery pattern to be embroidered. (page 150)

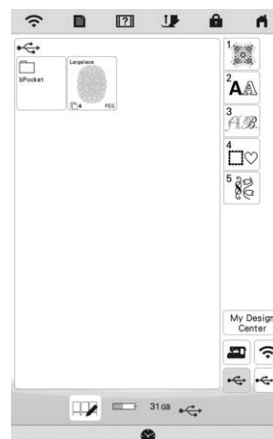

- Select section  to be embroidered.

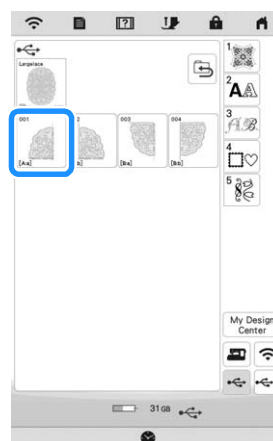

- Press **Set**.

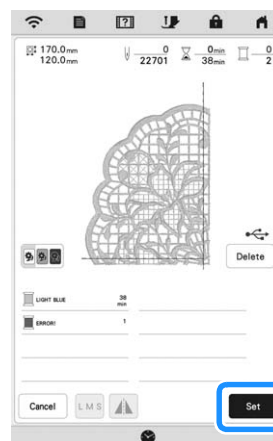

- 4 If necessary, press and edit the pattern.

Press to display the embroidery screen.



- 5 Embroider the pattern section.

- 6 When embroidering is finished, the following screen appears. Press .



→ A screen appears so that a section of the split embroidery pattern can be selected.

- 7 Repeat steps 2 through 6 to embroider the remaining sections of the pattern.



Chapter **6**
My Design Center



ABOUT MY DESIGN CENTER

With My Design Center, you can use the functions listed below:

- Hand-drawn functions - creating embroidery patterns by drawing on the LCD screen
- Loading functions - creating embroidery patterns by transferring data from the application or USB media.

You can also combine patterns that you have created with the machine's built-in patterns.

Start My Design Center by pressing  in the home

page screen or pressing  in the embroidery pattern selection screen.

PATTERN DRAWING SCREEN

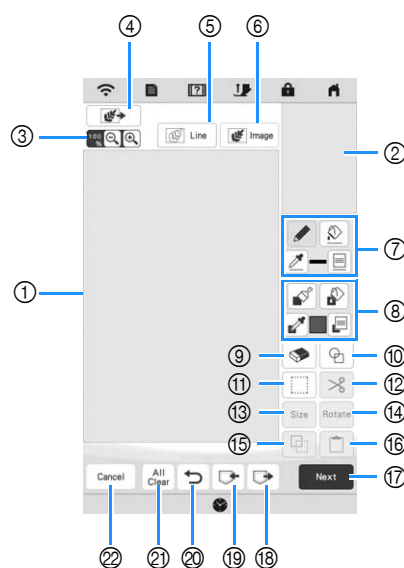

- ① Pattern drawing area
- ② Pattern preview area

Memo

- The actual dimension of the pattern area is the size of the embroidery frame, which is shown in the pattern preview area. The pattern you drew may be bigger than you expected. Please resize the pattern after converting the design to the embroidery pattern.
- When the pattern is enlarged so that only a part of it appears in the pattern drawing area, the entire pattern is displayed in the pattern preview area. The red frame in the pattern preview area indicates the part of the pattern displayed in the pattern drawing area. Move the red frame in the pattern preview area with the touch pen (stylus) or your finger to display the corresponding area in the pattern drawing area.

■ Key Functions



No.	Display	Explanation	Page
	Name		
③		Magnify the pattern.	159
	Magnify key		
④		Load the fabric as the background or the picture as the reference when creating the pattern. You can load the image file from the application or USB media.	164
	Load key		
⑤		Load a line drawing, then edit and convert it to embroidery data. You can load a line drawing from the application or USB media to create the embroidery design.	165
	Line design key		
⑥		Load an image, then edit and convert it to embroidery data. You can load an image from the application or USB media to create the embroidery design.	167
	Image design key		
⑦		Draw lines and set the color. You can select the line type, stitch type and color as you need. Press to pick up the color, line type and stitch type from a line in the pattern within the pattern drawing area. The picked up color is shown as the currently selected line color beside the button and as the selected color in the Line Property screen.	158
	Line tool key		
⑧		Paint with brush and set the color. You can select the brush type, fill type and color as you need. Painted lines and regions will be converted to the pattern to be embroidered with fill stitch. Press to pick up the color, brush type and fill type from a region in the pattern within the pattern drawing area. The picked up color is shown as the currently selected region color beside the button and as the selected color in the Region Property screen.	159
	Brush tool key		
⑨		Erase lines and shapes that have been drawn. You can select the size/shape of the eraser.	161
	Erase key		
⑩		Select the stamp shape for pattern drawing.	160
	Stamp key		
⑪		Select a section for moving by finger or pen, copying, deleting, changing size and rotating lines and shapes that have been drawn.	161
	Select key		
⑫		Cut out the selected section.	—
	Cut key		
⑬		Change the size of the selected section.	169
	Size key		
⑭		Rotate the selected section.	—
	Rotate key		

No.	Display	Explanation	Page
	Name		
⑮		Duplicate the selected section. The temporarily positioned section can immediately be rotated, enlarged, reduced or moved.	—
	Duplicate key		
⑯		Paste in the pattern drawing area a selected section duplicated with the duplicate key or a selected section using the cut key.	—
	Paste key		
⑰		Proceed to the stitch settings screen.	—
	Next key		
⑱		Recall image data created with My Design Center from the machine's memory or the USB media.	—
	Recall key		
⑲		Store the pattern being created to the machine's memory or the USB media.	—
	Memory key		
⑳		Undo the last operation that was performed and return to the previous state. Each press of this key will undo one operation.	—
	Undo key		
㉑		Clear all the lines and shapes and start from the beginning. The background image is also cleared.	—
	All Clear key		
㉒		Exit from My Design Center. All lines and shaped are erased when you press this key.	—
	Cancel key		

Before Creating Designs

The pattern preview displays the design smaller than the actual size. You can view the actual pattern size by setting the [Embroidery Frame Display].

With [Embroidery Frame Display] in the settings screen, the embroidery frame and grid can be specified separately.

- 1 Press  .
→ The settings screen appears.
- 2 Press  .
→ The embroidery settings screen appears.
- 3 Display [Embroidery Frame Display] in the embroidery settings screen.
- 4 Select the embroidery frame display.

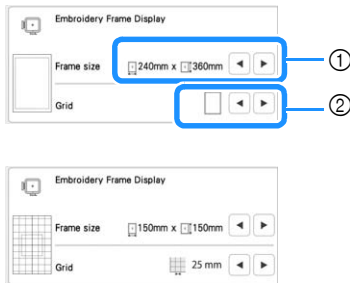

- ① Embroidery frame types
- ② Grid types

Drawing Lines

- 1 Press  and draw lines.

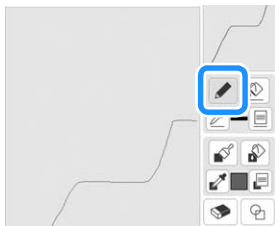

Memo

- When  is pressed, all regions will be displayed in the background to clarify the drawing lines on the screen.

Setting the Line Types, Stitch Types and Colors

You can set or change the line types, stitch types and colors anytime. You can also specify the line types, stitch types and colors before drawing lines.

- 1 Press  to set the line types, stitch types and colors.

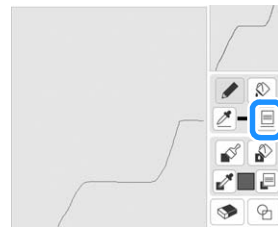



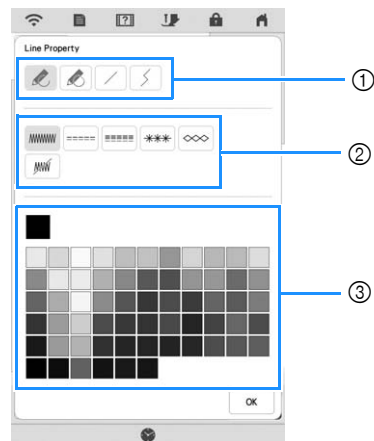

→ The settings screen appears.









- ① Line types
- ② Stitch types
- ③ Line color selection: touch the color palette to activate the drawing pen color.

Line types

	Freehand line with the end open.
	Freehand line closing the end automatically.
	Straight line with one stroke
	Straight line changing directions to the point you select. If the end point is created near the start point, a closed object will be created.

Stitch types

	Zigzag stitch
	Running stitch
	Triple stitch
	Candlewicking stitch
	Chain stitch
	Line without stitch for creating a region. Created region will be defined by the gray line.

2 Press  to return to the pattern drawing screen.

→ The color bar on the line tool key is changed to the selected color.

* The appearance of the line does not change even if the line type was changed. The specified line type can be checked in the stitch settings screen.

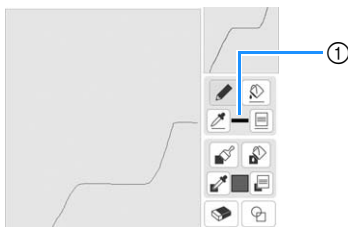



① Color bar

3 Press  then press on the line to change its color.

→ The connected line will be changed to the selected color.

Memo

- Press  to magnify the image when you cannot press on the line correctly.
- Press , and then select a color within the pattern drawing area to apply the same color to other lines or parts of the pattern.

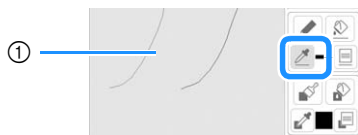

① Use  to select the line color.

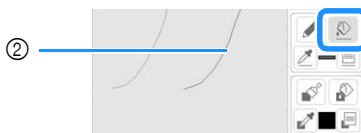

② Press  for changing the line color, and then select the pattern to be changed.

Drawing Regions

1 Press  and draw with brush.







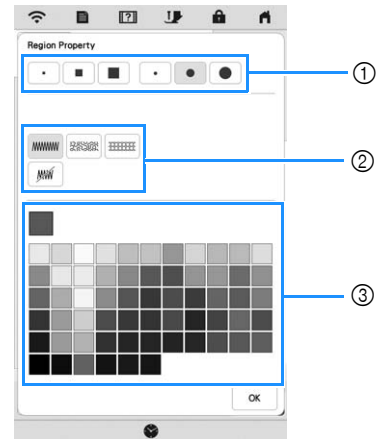





Setting the Brush Types and Fill Colors

1 Press  to set the brush types and fill colors.







- ① Brush types
- ② Fill stitch types
- ③ Fill color selection: touch the color palette to activate the paint brush color.

Brush shapes/sizes

	Square brush	
	Round brush	
	Small brush	
	Medium brush	
	Large brush	

Fill stitch types

	Fill stitch
	Stippling stitch
	Decorative fill stitches Displays a stitch selection screen, where  can be pressed to select a stitch.



Select  when you don't want fill stitch.

2 Press to return to the pattern drawing screen.

→ The color bar on the brush tool key is changed to the selected color. If a stippling stitch or decorative fill stitch has been selected, the stitch is displayed.

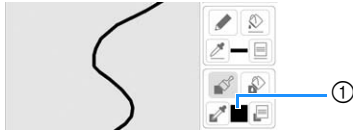

① Color bar

3 Press and press on the brush line to change color and fill stitch type. You can also set the color and fill stitch type of a closed region made of the line.

Memo

- Press to magnify the image when you cannot press on the fill correctly.
- Press , and then select a pattern color in the pattern drawing area to apply that fill color to other patterns.

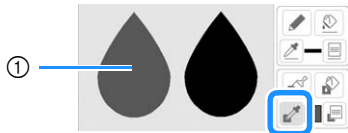

① Use to select the fill color.

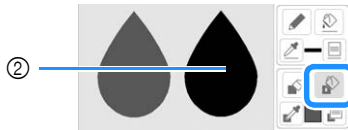

② Press for changing the fill color, and then select the pattern to be changed.

Using the Stamp Key

1 Press .



2 Select a stamp type and stamp shape.

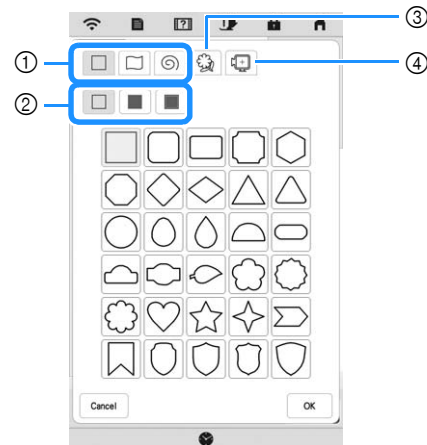

- ① Stamp shapes
- ② Stamp types
- ③ Saved outlines
- ④ Frame embroidering areas

Stamp shapes

	Basic shapes
	Closed shapes
	Open shapes

Stamp types (Only for Basic shapes)

	Outline
	Fill stitch
	Outline and fill stitch

* Select the outline () , fill stitch () , or outline and fill stitch () of a basic shape.

Saved outlines

 Embroidery pattern outlines can be registered as stamp shapes. When registering stamp shapes, select from the last six embroidery patterns used. If more than six shapes are registered, the oldest one is automatically erased. For details on registering a stamp shape, refer to “Decorative Stitching around a Pattern in Embroidery (a Quilting Function)” on page 171.

Frame embroidering areas

 Select an embroidering area in order to arrange the pattern to fit an embroidery frame.

* Press to return to the pattern drawing screen.

3 Press to set the selected stamp.

→ The pattern drawing screen appears.

* You can change size of, rotate or move the shape right after you create it by pressing or .

Using the Erase Key

1 Press .

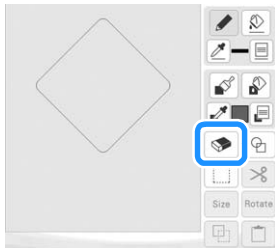

2 Select the shape of the eraser.



→ The pattern drawing screen appears.

3 Drag along the area or line that you want to erase while the key appears as .

Using the Select Key

You can select the part of the design to move and/or edit. Some keys are available only after you select the part.

1 Press .

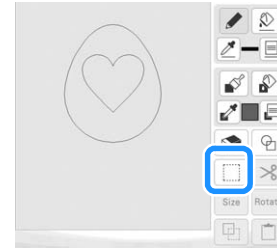

2 Select the area you want to edit.

* To select an area you want to edit, hold the touch pen (stylus) at a point on the screen and drag the touch pen (stylus) to create the red box around your selected area to be edited.

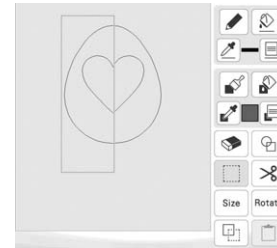

3 Edit the design with available keys. (Refer to “Key Functions” on page 157 for the details of each key function.)

4 Press , and then specify the stitch setting.

STITCH SETTINGS SCREEN

Before creating the embroidery pattern, specify the stitch settings. Lines of the design are embroidered with various stitches and regions are embroidered with fill stitches or stippling stitches. Stitching of the regions was already selected in "Drawing Regions" on page 159, so specify values of detailed settings.

After specifying the settings, press to create the embroidery pattern.

Specifying Individual Stitch Settings

Select a pattern in the stitch settings screen to specify its line and region stitch settings. If multiple patterns are selected, the settings are applied to those patterns.

Line Settings

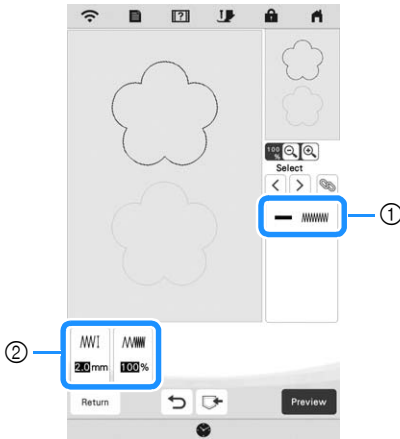

- ① Shows the stitch type and color for the selected line.
- ② Shows the stitch settings for the selected line.

Line stitch settings

Select the type of stitching you want applied to your line art, from zigzag stitch (), running stitch (), triple stitch (), candlewicking stitch () or chain stitch ().

Zigzag stitch

Zigzag width	Specifies the width of the stitch.
Density	Specifies the density of the stitch.

Running stitch /Triple stitch

* Both includes an under sewing.

Run pitch	Specifies the length of the stitch.
-----------	-------------------------------------

Candlewicking Stitch

Size	Increases/reduces the size of the stitch.
Spacing	Specifies the spacing of the stitch.

Chain stitch

Size	Increases/reduces the size of the stitch.
Repetition	Sets repeated embroidering at the same part.

Region Settings

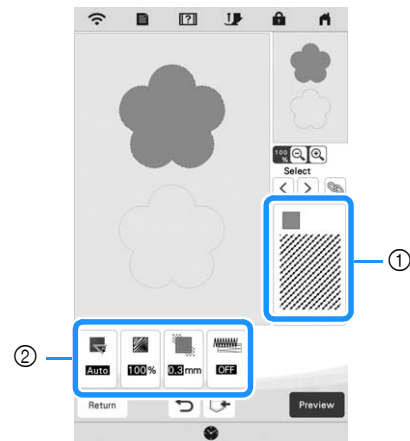

- ① Shows the stitch type and color for the selected region.
- ② Shows the stitch settings for the selected region.

Fill stitch settings

Direction	Specifies the embroidering direction. Select <input type="button" value="Manual"/> to change to the desired direction of fill stitch.
Density	Specifies the stitch density of fill stitch.
Pull compensation	Specifies to correct the shrinkage of the pattern by slightly shortening or lengthening the stitching. Change the setting after you embroider the pattern and can check the shrinkage.
Under sewing	Select if you need or do not need the under sewing for the stabilized fabric.

Stippling stitch settings

Run pitch	Specifies the length of a stitch of the stippling stitch.
Spacing	Specifies the spacing between the stitches when embroidering the stippling stitch.
Distance	Specifies the offset from the pattern outline.

Decorative fill stitch settings

Size	Increases/reduces the size of the pattern.
Direction	Specifies the rotation angle of the pattern.
Outline	Select whether [ON] or [OFF] the outline is also converted to embroidery data. If [ON] is selected, the number of thread jumps can be reduced.

1 Use to select the line or region to be changed.

→ Each press of moves the highlighting of the selected pattern in order.

2 Select the setting to be changed, and then change the setting in the screen that appears. (In this example, the embroidering direction will be changed.)



→ The setting screen appears.

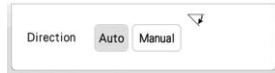

3 Press , and then use to change the direction.



4 Press to apply the setting.

- * appears on the tab for settings that were changed.
- * Change other settings in the same way.

Specifying Global Stitch Settings

The same stitch settings can be changed at the same time for multiple patterns of the same type.

1 Use to select the stitch whose settings are to be changed, and then press .

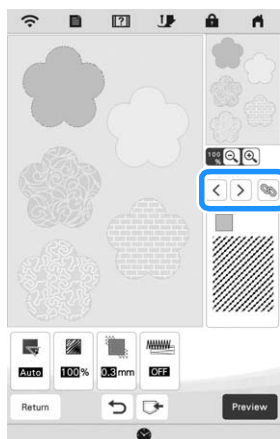

→ The same stitch type lines or regions will be selected at the same time.

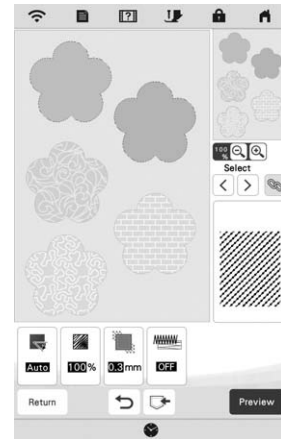

2 Follow steps 2 through 4 in “Specifying Individual Stitch Settings” on page 162 to change the settings.

3 Press to create the embroidery pattern.

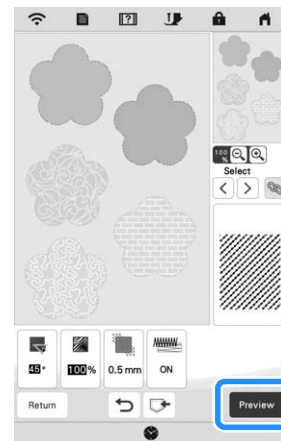

→ When the following message appears, press .



4 Press **Set** to display the pattern editing screen.

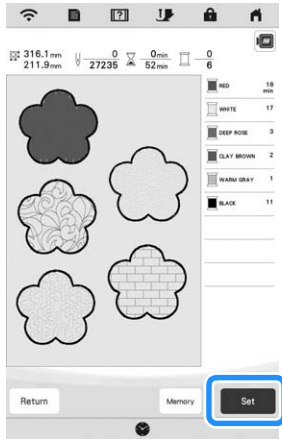

→ When the following message appears, press **OK**.

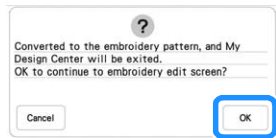

- ①  : Check an enlarged view of the pattern.
- ② **Memory** : Save the embroidery data.

Loading the Background Image

Prepare the data file of your favorite picture so that you can create an embroidery pattern. Load the image file from the application or a USB media.

1 Press .



2 Select the device you saved the data to.



3 Select the data, and then press **Set**.

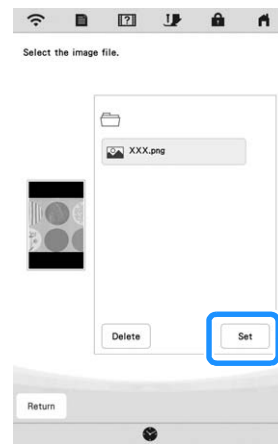

4 The selected image is displayed transparently in the pattern drawing area.





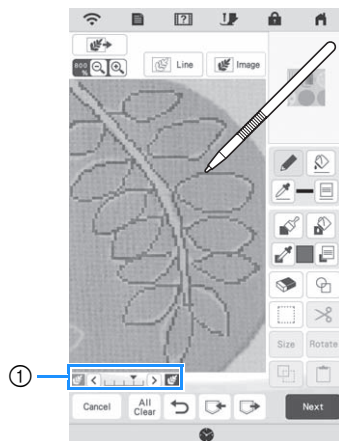

- 5 Using the included touch pen (stylus), press , and then draw lines to trace the image.

* For details on drawing lines, refer to “Drawing Lines” on page 158.



- ① Transparency adjustment

* Press  or  to adjust the transparency of the background.

Each press of  lightens the background, making the line pattern darker. Each press of  darkens the background, making the line pattern lighter.

- 6 After editing the pattern, press  to specify the settings for pattern.

- 7 Press  to create the embroidery pattern.

LINE CONVERSION

Custom patterns can be created from drawings. You can create patterns by loading an image on the application or a USB media.

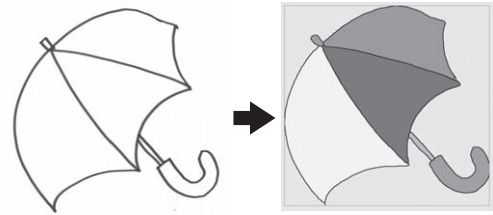

Recommended line drawings for Line Conversion

- Line drawings must be drawn clearly using lines with approximately 1 mm thickness.
- Line drawings should be drawn in a strong contrast.
- If the lines are too short or gathered too densely, they will not be loaded correctly.

Note

- For details on creating patterns using color illustrations, refer to “ILLUSTRATION CONVERSION” on page 167.
- If you cannot convert the drawings as expected, you can edit the design in My Design Center. Refer to “PATTERN DRAWING SCREEN” on page 156.
- Line drawings are converted without recognizing the thickness of lines. If you want to change the thickness of lines, specify in the settings screen. Refer to “STITCH SETTINGS SCREEN” on page 162.
- Line drawings are converted as black lines. If you want to change the colors, specify in My Design Center. Refer to “Drawing Lines” on page 158.

Create a Pattern with Line Conversion

- 1 Press  .

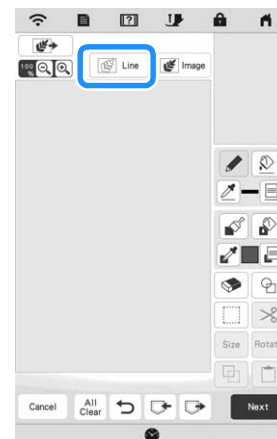

→ The image display screen appears.

2 Select the device you saved the data to.



3 Select the data, and then press **Set**.

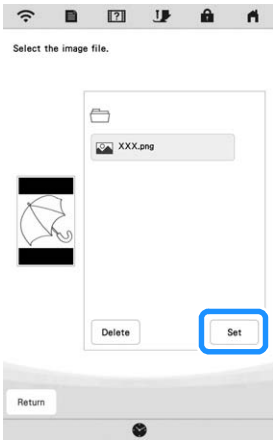

4 When loading is finished, specify the [Gray-Scale Detection level] on the screen if necessary.

The [Gray-Scale Detection level] can change the black and white threshold for the image.



- * If you do not know how the settings should be changed, first continue the operation without specifying settings and check the results.
- * To stop loading and return to the screen in step **2**, press **Cancel**. The loaded image will be deleted when you return to the previous screen.

5 Move to frame the image for the pattern.

6 Press **OK**.

→ The screen for confirming the converted image appears.

7 In the screen for confirming the converted image, you can adjust the [Gray-Scale Detection level] again, if necessary.

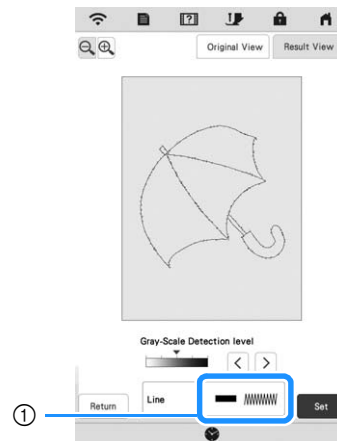

① The settings for the lines to be embroidered appear.

- * If you do not know how the settings should be changed, first continue the operation without specifying settings and check the results.
- * : Enlarge the image.
- * **Original View** : Display the image before being converted. Compare the images before and after being converted, and then change the settings if necessary.
- * **Return** : Return to the previous screen.

→ After changes to the settings for [Gray-Scale Detection level] are applied, **Set** changes to **Retry**. Press **Retry** to check that the image is as desired.

8 Press **Set**.

→ The pattern drawing screen appears.

9 If necessary, edit the loaded image.

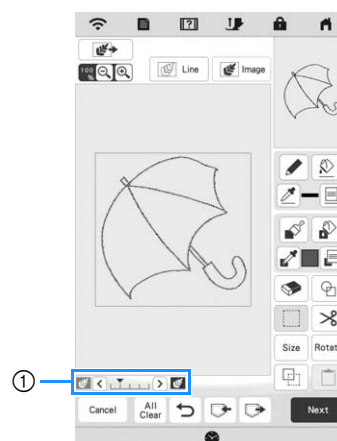

- * After the loaded image is converted to stitching, it appears as a background in the pattern drawing screen. Use gauge ① to adjust the transparency of the background. Each press of lightens the background, making the line pattern darker. Each press of darkens the background, making the line pattern lighter.

ILLUSTRATION CONVERSION

Custom patterns can be created from color illustrations. You can create patterns by loading an image on the application or a USB media.

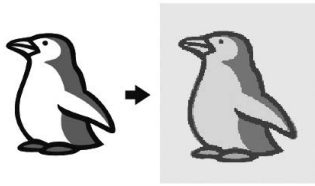

Recommended illustrations for Illustration Conversion

- Illustrations that are clearly drawn, with no gradation, fading or blurriness.
- Illustrations that are at least a 5 mm square
- Illustrations that are extremely simple images

Create a Pattern with Illustration Conversion

1 Press Image .

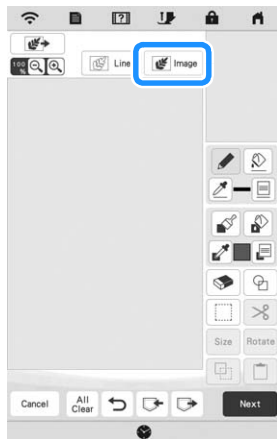

→ The image display screen appears.

2 Select the device you saved the data to.



3 Select the data, and then press .



4 When loading is finished, specify the necessary settings in the loaded image confirmation screen.

Change the settings to adjust the image so it can easily be converted to the desired pattern.

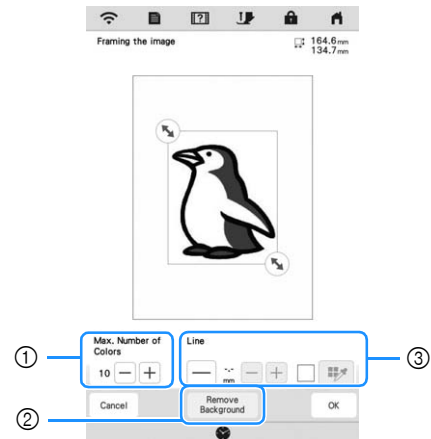

①	[Max. Number of Colors]	The number of colors in an image will be reduced less than the number specified here, and then the outline will be extracted.
②	[Remove Background]	Select whether or not the background color will be included as one of the colors.
③	[Line]	Select whether or not the outline will be detected as a line. A thick outline can also be detected as a region. When detected as a line, the line thickness and color can be specified.

* To stop loading and return to the screen in step 2, press .

Memo

- Press to detect the outline. Line thickness can be specified from 1.0 mm (1/16 inch) to 5.0 mm (3/16 inch).

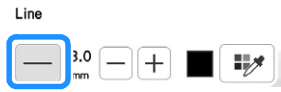

- Press to select the outline color. Select by touching the color, or moving icon using



in the color selection screen.

5 Move to frame the image for the pattern.

6 Press .

→ The screen for confirming the converted image appears.

7 In the screen for confirming the converted image, adjust the image as necessary as in step 4.



- * : Enlarge the image.
 - * : Display the image before being converted. Compare the images before and after being converted, and then change the settings if necessary.
 - * : Return to the previous screen.
- After changes to the settings described above have been applied, changes to . Press to check that the image is as desired.

8 Press .

→ The pattern drawing screen appears.

9 If necessary, edit the loaded image.

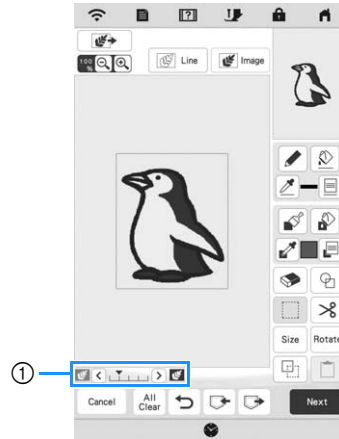

- * After the loaded image is converted to stitching, it appears as a background in the pattern drawing screen. Use gauge ① to adjust the transparency of the background. Each press of lightens the background, making the illustration pattern darker. Each press of darkens the background, making the illustration pattern lighter.

STIPLING

Basic Stipling with My Design Center

Create a stipling design with the basic procedure.

Example:

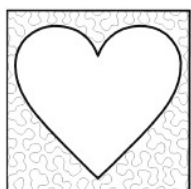

Note

- You can load a line drawing to create a stipling stitch or use image design function of a fabric pattern and incorporate the stipling stitch.

1 Press  .

* You can also start the function by pressing  in the embroidery pattern selection screen.

2 Press  .

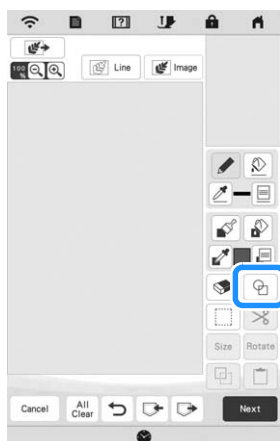

3 Select the square shape, and then press  .

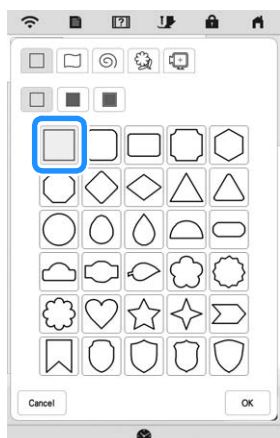

4 Press  .

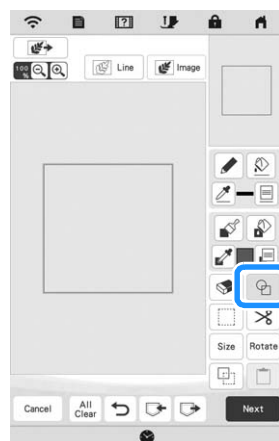

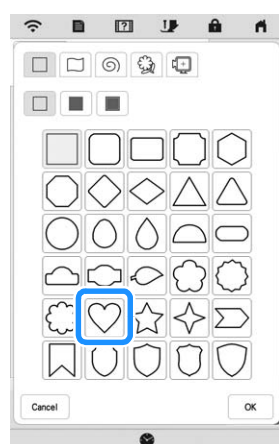

5 Select the heart shape, and then press  .



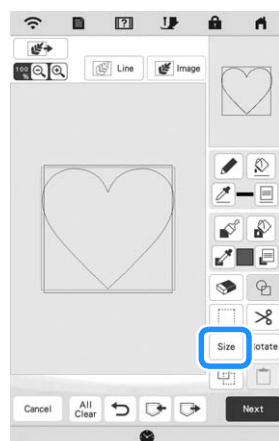

6 Press  .

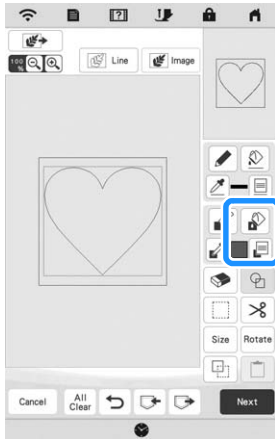

7 Press  until the heart shape fits in the square shape, and then press .

8 Press , and then press .



9 Press , and then select the stitch color. Press after setting the color.

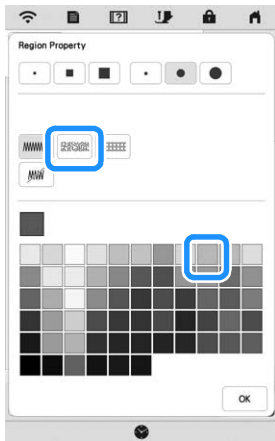

10 Select the region you want to set stippling effect.

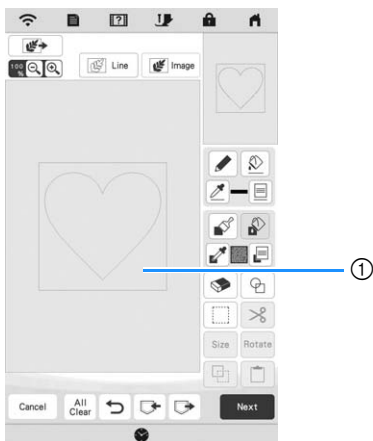

① Select this region.

11 Press .

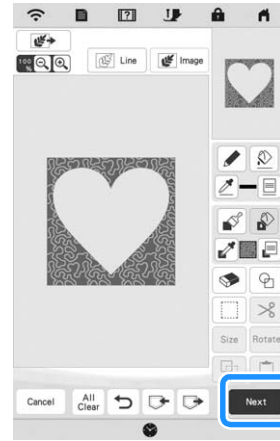

12 Adjust the stippling stitch settings to create the desired effect, and then press .

* For details, refer to "Specifying Individual Stitch Settings" on page 162.

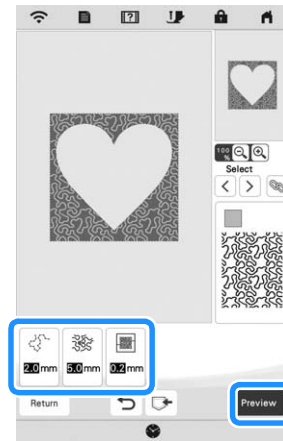

→ When the following message appears, press .



13 Press **Set** to convert into embroidery.

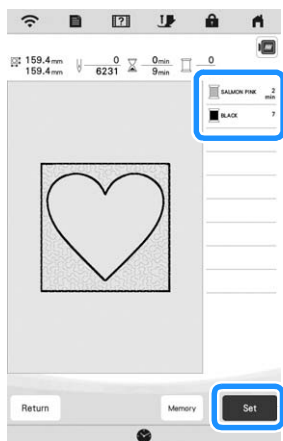

→ When the following message appears, press **OK**.

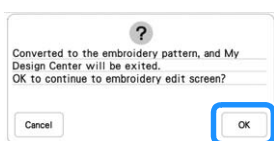



14 Follow the procedure described on “EDITING PATTERNS” on page 114 to edit the pattern as desired.

Decorative Stitching around a Pattern in Embroidery (a Quilting Function)

Memo

- For best results, reduce the embroidery speed. (page 29)

A quilt can be created with stippling stitch around an embroidery pattern.

- 1 Hoop the top layer of fabric in the embroidery frame, and then attach the frame to the machine.
- 2 Press  in the home page screen and select the pattern that decorative stitching will be added around, and then press  in the embroidery edit screen.



→ The outline of the pattern is displayed.



- 3 Set the distance and press **Memory**.



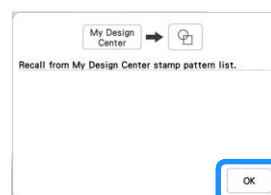

→ A message appears, and the pattern outline is registered as a stamp shape in My Design Center.

Press **OK**.

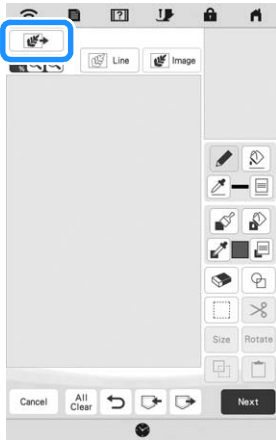

- 4 Press **Embroidery** to continue to the embroidery screen, and then embroider the pattern at the center.
- 5 Remove the embroidery frame from the carriage.
- 6 Photograph the embroidery frame with the application.
- 7 Attach the embroidery frame to the carriage again.
- 8 Place the batting and bottom layer of fabric under the embroidery frame.
- 9 Press  in the home page screen to start My Design Center.
- 10 Press  to load the embroidered fabric. Refer to "Loading the Background Image" on page 164 for details.



- 11 Press , press  to recall the stamp shape registered in step 3, and then arrange it over the loaded pattern.



- 12 Use a stamp or rectangular frame to determine the region to be stitched.

Note

- If the region is to be drawn by hand, be sure to draw a completely closed shape. If the region is not closed, it will not be correctly closed with any of the fill stitches.



- 13 Use the brush tool keys to select the stitch and color of the decorative stitching.



- 14 Fill the region to be stitched outside of the stamp shape outline.



- 15 Set the line type for the frame and pattern to , and then press **Next**.

* Stitch settings can be adjusted in the stitch settings screen. For details, refer to “STITCH SETTINGS SCREEN” on page 162.



- 16 Specify the stitch spacing and length in the stitch settings screen, and then press **Preview**.



→ Check the pattern, and then press **Set**.



- 17 Embroider the stippling stitch around the embroidery pattern.



Chapter **7**
Appendix



CARE AND MAINTENANCE

⚠ CAUTION

- Be sure to unplug the machine before cleaning it. Otherwise, electric shock or injury may result.

If the surface of the machine is dirty, lightly soak a cloth in neutral detergent, squeeze it out firmly, and then wipe the surface of the machine. After cleaning it once with a damp cloth, wipe it again with a dry cloth.

If the screen is dirty, gently wipe it with a soft, dry cloth. Do not wipe the LCD screen with a damp cloth. Do not use organic solvents or detergents.

Restrictions on Oiling

In order to prevent damaging this machine, it must not be oiled by the user. This machine was manufactured with the necessary amount of oil applied to ensure correct operation, making periodic oiling unnecessary.

If problems occur, such as difficulty turning the handwheel or an unusual noise, immediately stop using the machine, and contact your authorized Brother dealer or the nearest Brother authorized service center.

Precautions on Storing the Machine

Do not store the machine in any of the locations described below, otherwise damage to the machine may result, for example, rust caused by condensation.

- * Exposed to extremely high temperatures
- * Exposed to extremely low temperatures
- * Exposed to extreme temperature changes
- * Exposed to high humidity or steam
- * Near a flame, heater or air conditioner
- * Outdoors or exposed to direct sunlight
- * Exposed to extremely dusty or oily environments

💡 Note

- In order to extend the life of this machine, periodically turn it on and use it. Storing this machine for an extended period of time without using it may reduce its efficiency.

Cleaning the Race

- 1 Press  (Needle position button) to raise the needle.
- 2 Turn the main power to OFF.
- 3 Remove the needle, presser foot and presser foot holder (page 48, page 50).
- 4 Remove the bobbin cover.

- 5 Slide the needle plate cover toward you to remove it.

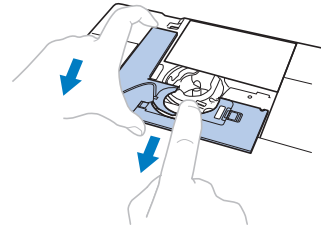

💡 Note

- If the flat bed attachment is attached, the needle plate can be removed when the accessory compartment is opened.

- 6 Grasp the bobbin case, and then gently lift out.

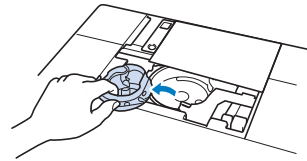

- 7 Use the cleaning brush or a vacuum cleaner to remove any lint and dust from the race and bobbin thread sensor and the surrounding area.

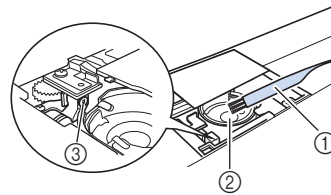

- ① Cleaning brush
- ② Race
- ③ Bobbin thread sensor

💡 Note

- Do not apply oil to the bobbin case.
- If lint or dust collects on the bobbin thread sensor, the sensor may not operate correctly.

- 8 Insert the bobbin case so that the ▲ mark on the bobbin case aligns with the ● mark on the machine.

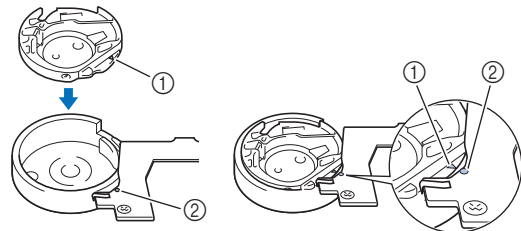

- * Align the ▲ and ● marks.

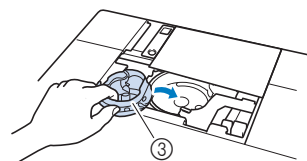

- ① ▲ mark
- ② ● mark
- ③ Bobbin case

* Make sure that the indicated points are aligned before installing the bobbin case.

⚠ CAUTION

- Never use a bobbin case that is scratched, otherwise the upper thread may become tangled, the needle may break or machine performance may suffer. For a new bobbin case, contact your nearest Brother authorized service center.
- Be sure that the bobbin case is correctly installed, otherwise the needle may break.

- 9 Insert the tabs on the needle plate cover into the needle plate, and then slide the cover back on.

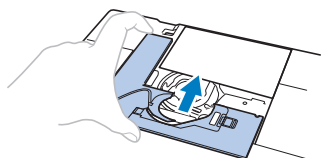

- 10 Reattach the bobbin cover.

Cleaning the Cutter in the Bobbin Case Area

The cutter below the needle plate should be cleaned. If dust or lint accumulate on the cutter, it will be difficult to cut the thread when  (Thread cutter button) is pressed or the automatic thread cutting function is used. Clean the cutter when the thread is not easily cut.

- 1 Follow steps 1 through 5 in “Cleaning the Race” to remove the needle plate cover.
- 2 Use the screwdriver included with the machine to unscrew and remove the needle plate.

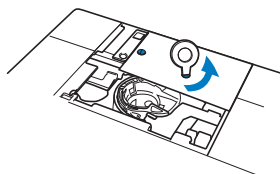

- 3 Use the cleaning brush or a vacuum cleaner to remove any lint and dust from the cutter in the bobbin case area.

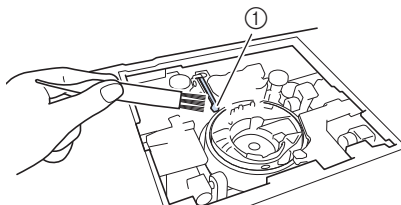

① Cutter

⚠ CAUTION

- Do not touch the cutter, otherwise injuries may result.

- 4 Align the two screw holes in the needle plate with the two holes at the needle plate mounting base, and then fit the needle plate onto the machine.
- 5 Lightly finger-tighten the screw on the right side of the needle plate. Then, use the screwdriver included to firmly tighten the screw on the left side. Finally, firmly tighten the screw on the right side.

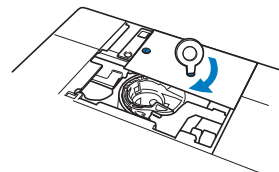

- 6 Replace the bobbin case and the needle plate cover following steps 8 through 10 in “Cleaning the Race”.

💡 Note

- If the needle plate has been removed, check machine operations to confirm that installation has been completed correctly. Refer to “Checking Machine Operations” on page 181.

ADJUSTING THE SCREEN

Touch Panel is Malfunctioning

If the screen does not respond correctly when you touch a key (the machine does not perform the operation or performs a different operation), follow the steps below to make the proper adjustments.

- 1 Holding your finger on the screen, turn the main power switch to OFF and back to ON.



→ The touch panel adjustment screen appears.

- 2** Using the included touch pen, lightly touch the center of each +, in order from 1 to 13.

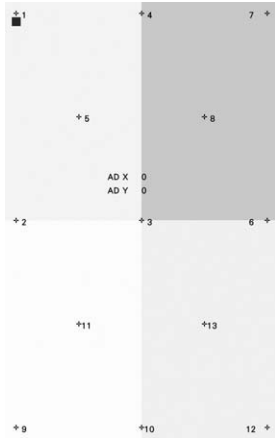

Note

- Only use the included touch pen to touch the screen. Do not use a mechanical pencil, pin, or other sharp object. Do not press too hard on the screen. Otherwise, damage may result.

- 3** Turn the main power to OFF, then turn it back to ON.

Note

- If you finish the screen adjustment and the screen still does not respond, or if you cannot do the adjustment, contact your authorized Brother dealer.

TROUBLESHOOTING

If the machine stops operating correctly, check the following possible problems before requesting service. You can solve most problems by yourself. If you need additional help, the Brother Solutions Center offers the latest FAQs and troubleshooting tips. Visit us at “ <http://s.brother/cpeaa/> ”.

If the problem persists, contact your authorized Brother dealer or the nearest Brother authorized service center.

Frequent Troubleshooting Topics

Detailed causes and remedies for common troubleshooting topics are described below. Be sure to refer to this before contacting your authorized Brother dealer.

■ Upper Thread is Too Tight	page 17 8
■ Tangled Thread on Wrong Side of Fabric	page 17 9
■ Incorrect Thread Tension	page 17 9
■ Fabric is Caught in the Machine and Cannot Be Removed	page 18 0
■ Untangling Thread from beneath the Bobbin Winder Seat	page 18 2

Upper Thread is Too Tight

■ **Symptom**

- * The upper thread appears as a single continuous line.
- * The bobbin thread is visible from the right side of the fabric. (Refer to the illustration below.)
- * The upper thread has tightened up, and comes out when pulled.
- * The upper thread has tightened up, and wrinkles appear in the fabric.
- * The upper thread tension is tight, and the results do not change even after the thread tension is adjusted.

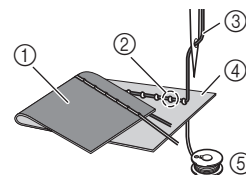

- ① Wrong side of fabric
- ② Bobbin thread visible from right side of fabric
- ③ Upper thread
- ④ Right side of fabric
- ⑤ Bobbin thread

■ Cause

Incorrect bobbin threading

If the bobbin thread is incorrectly threaded, instead of the appropriate tension being applied to the bobbin thread, it is pulled through the fabric when the upper thread is pulled up. For this reason, the thread is visible from the right side of the fabric.

■ Remedy

Correctly install the bobbin thread. (page 40)

Tangled Thread on Wrong Side of Fabric

■ Symptom

- * The thread becomes tangled on the wrong side of the fabric.

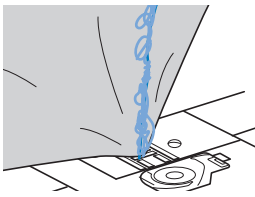

- * After starting sewing, a rattling noise is made and sewing cannot continue.
- * Looking under the fabric, there is tangled thread in the bobbin case.

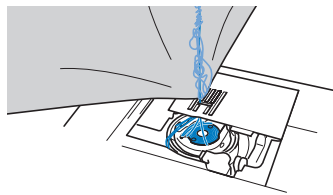

■ Cause

Incorrect upper threading

If the upper thread is incorrectly threaded, the upper thread passed through the fabric cannot be firmly pulled up and the upper thread becomes tangled in the bobbin case, causing a rattling noise.

■ Remedy

Remove the tangled thread, and then correct the upper threading.

- 1 **Remove the tangled thread. If it cannot be removed, cut the thread with scissors.**

- * Refer to "Cleaning the Race" on page 176.

- 2 **Remove the upper thread from the machine.**

- 3 **Correct the upper threading by following the instructions in "Upper Threading" on page 42.**

- * If the bobbin was removed from the bobbin case, refer to "Setting the Bobbin" on page 40 to correctly install the bobbin.

Incorrect Thread Tension

■ Symptoms

- Symptom 1: The bobbin thread is visible from the right side of the fabric.
- Symptom 2: The upper thread appears as a straight line on the right side of the fabric.
- Symptom 3: The upper thread is visible from the wrong side of the fabric.
- Symptom 4: The bobbin thread appears as a straight line on the wrong side of the fabric.
- Symptom 5: The stitching on the wrong side of the fabric is loose or has slack.

Symptom 1

Symptom 3

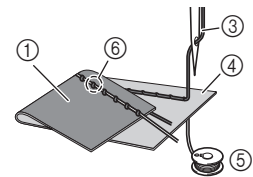
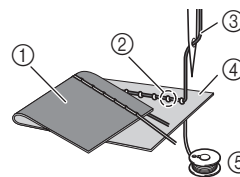

- ① Wrong side of fabric
- ② Bobbin thread visible on right side of fabric
- ③ Upper thread
- ④ Right side of fabric
- ⑤ Bobbin thread
- ⑥ Upper thread visible from wrong side of fabric

■ Cause/Remedy

Cause 1

The machine is not correctly threaded.

<With symptoms 1 and 2 described above>

The bobbin threading is incorrect.

Adjust the upper thread tension and then refer to "Upper Thread is Too Tight" on page 178.

<With symptoms 3 through 5 described above>

The upper threading is incorrect.

Adjust the upper thread tension and then refer to "Tangled Thread on Wrong Side of Fabric" on page 179 to correct the upper threading.

Cause 2

A needle and thread appropriate for the fabric are not being used.

The machine needle that should be used depends on the type of fabric sewn and the thread thickness.

If a needle and thread appropriate for the fabric are not being used, the thread tension will not be adjusted correctly, causing wrinkles in the fabric or skipped stitches.

- * Refer to "FABRIC/THREAD/NEEDLE COMBINATIONS" on page 49 to check that a needle and thread appropriate for the fabric are being used.

Cause 3

An appropriate upper tension is not selected.

Select an appropriate thread tension. Refer to "Setting the Thread Tension" on page 62.

The appropriate thread tension differs according to the type of fabric and thread being used.

- * Adjust the thread tension while test sewing on a piece of scrap fabric that is the same as that used in your project.

Note

- If the upper threading and bobbin threading are incorrect, the thread tension cannot be adjusted correctly. Check the upper threading and bobbin threading first, and then adjust the thread tension.

*** When the bobbin thread is visible on the right side of the fabric.**

Set the upper thread tension to a lower number. (Loosen the thread tension.)

*** When the upper thread is visible on the wrong side of the fabric.**

Set the upper thread tension to a higher number. (Tighten the thread tension.)



Fabric is Caught in the Machine and Cannot Be Removed

If the fabric is caught in the machine and cannot be removed, the thread may have become tangled under the needle plate. Follow the procedure described below to remove the fabric from the machine. If the operation cannot be completed according to the procedure, instead of attempting to complete it forcefully, contact your nearest Brother authorized service center.

■ Removing the Fabric From the Machine

- 1 Immediately stop the machine.**
- 2 Turn off the machine.**
- 3 Remove the needle.**
If the needle is lowered into the fabric, turn the handwheel away from you (clockwise) to raise the needle out of the fabric, and then remove the needle.
* Refer to "CHANGING THE NEEDLE" on page 48.
- 4 Remove the presser foot and presser foot holder.**
If the thread is entangled on the presser foot, remove the entangled thread, and then raise the presser foot lever to remove the presser foot. Otherwise, the presser foot may be damaged.
* Refer to "CHANGING THE PRESSER FOOT" on page 50.
- 5 Lift up the fabric and cut the threads below it.**
If the fabric can be removed, remove it.
- 6 Remove the needle plate cover.**
* Refer to "Cleaning the Race" on page 176.

7 Cut out the tangled threads, and then remove the bobbin.

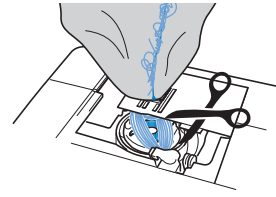

8 Remove the bobbin case.

If threads remain in the bobbin case, remove them.

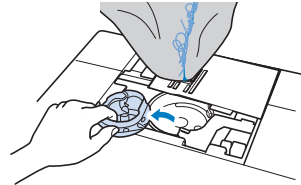

9 Use the cleaning brush or a vacuum cleaner to remove any lint or dust from the race and its surrounding area.

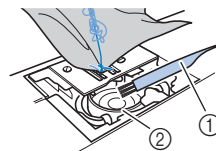

- ① Cleaning brush
- ② Race

If the fabric could be removed	Continue with step 16 .
If the fabric could not be removed	Continue with step 10 .

Note

- Compressed can air is not recommended to be used.

10 Use the disc-shaped screwdriver to loosen the two screws on the needle plate.

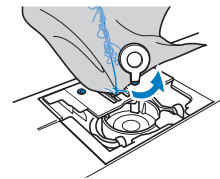

Note

- Be careful not to drop the removed screws in the machine.

- 11** Slightly lift up the needle plate, cut any tangled threads, and then remove the needle plate.

Remove the fabric and threads from the needle plate.

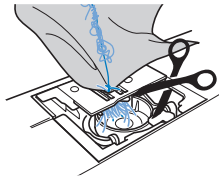

Note

- If the fabric cannot be removed, even after completing these steps, contact your nearest Brother authorized service center.

- 12** Remove any threads in the race and around the feed dogs.

- 13** Turn the handwheel to raise the feed dogs.

- 14** Align the two screw holes in the needle plate with the two holes at the needle plate mounting base, and then fit the needle plate onto the machine.

- 15** Lightly finger-tighten the screw on the right side of the needle plate. Then, use the disc-shaped screwdriver to firmly tighten the screw on the left side. Finally, firmly tighten the screw on the right side.

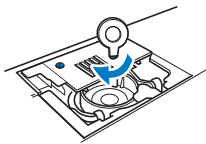

- 16** Replace the bobbin case and the needle plate cover following steps **8** through **10** in “Cleaning the Race”.

- 17** Check the condition of the needle, and then install it.

If the needle is in a poor condition, for example, if it is bent, be sure to install a new needle.

* Refer to “CHANGING THE NEEDLE” on page 48.

Memo

- Since the needle may have been damaged when the fabric was caught in the machine, we recommend replacing it with a new one.

■ Checking Machine Operations

If the needle plate has been removed, check machine operations to confirm that installation has been completed correctly.

- 1** Turn on the machine.

- 2** Select .

Note

- Do not yet install the presser foot and thread.

- 3** Slowly turn the handwheel toward you (counterclockwise), and look from all sides to check that the needle falls at the center of the opening in the needle plate.

If the needle contacts the needle plate, remove the needle plate, and then install it again, starting with step **13** in “Removing the Fabric From the Machine” on page 180.

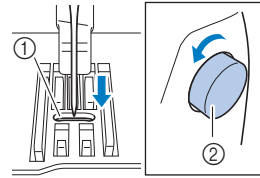

- ① Opening in the needle plate
② Handwheel

- 4** Select zigzag stitch . At this time, increase the stitch length and width to their maximum settings.

- 5** Slowly turn the handwheel toward you (counterclockwise) and check that the needle bar and feed dogs operate correctly.

Turn the handwheel to check that the feed dogs move smoothly and do not contact the edges of the slots in the needle plate.

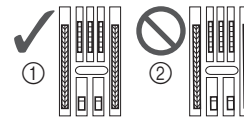

- ① Correct position of feed dogs
② Incorrect position of feed dogs

Memo

- If the needle or feed dogs contact the needle plate, the machine may be malfunctioning; therefore, contact your nearest Brother authorized service center.

- 6** Turn off the machine, and then install the presser foot holder, presser foot and bobbin.

Never use a scratched or damaged presser foot. Otherwise, the needle may break, or machine performance may suffer.

* Refer to “Setting the Bobbin” on page 40 and “CHANGING THE PRESSER FOOT” on page 50.

- 7** Correctly thread the machine.

* For details on the machine, refer to “UPPER THREADING” on page 42.

- 8** Perform trial sewing with normal fabric.

Note

- Incorrect sewing may be the result of incorrect upper threading or sewing thin fabrics. If there are poor results from the trial sewing, check the upper threading or the type of fabric being used.

Untangling Thread from beneath the Bobbin Winder Seat

If the bobbin winding starts when the thread is not passed through the pretension disk correctly, the thread may become tangled beneath the bobbin winder seat. Wind off the thread according to the following procedure.



⚠ CAUTION

- Do not remove the bobbin winder seat even if the thread becomes tangled under the bobbin winder seat. It may result in injuries.

1 Press  to stop the bobbin winding.



2 Cut the thread with scissors near the pretension disk.

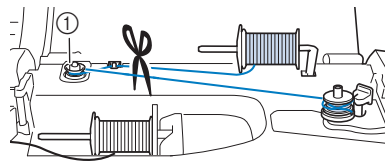

① Pretension disk

3 Push the bobbin winder switch to the right, and then raise the bobbin at least 10 cm (4 inches) from the shaft.

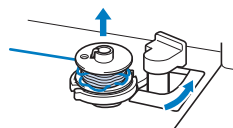

4 Cut the thread near the bobbin to completely remove the bobbin from the shaft. Hold the thread end with your left hand, and wind off the thread clockwise from under the bobbin winder seat with your right hand as shown below.

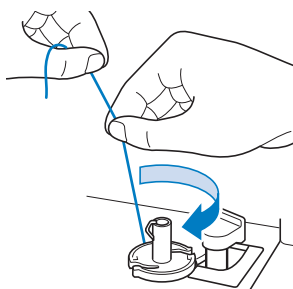



List of Symptoms

Check the following possible problems before requesting service. If the reference page is “*”, contact your authorized Brother dealer or the nearest Brother authorized service center.

■ Getting Ready

Symptom, Cause/solution	Reference
Cannot thread the needle.	
Needle is not in the correct position. • Press  (Needle position button) to raise the needle.	13
Needle is installed incorrectly.	48
Needle is turned, bent or the point is dull.	48
Upper threading is incorrect.	42
The needle threader hook is bent and does not pass through the eye of the needle.	*
The needle threader lever cannot be moved or returned to its original position.	*
A size 65/9 needle is being used. • The needle is incompatible with the needle threader. Manually pass the thread through the eye of the needle.	43

Cannot lower the presser foot with the presser foot lever.



Presser foot was raised using  (Presser foot lifter button). • Press  (Presser foot lifter button) to lower the presser foot.	13
--	----

Bobbin thread does not wind neatly on the bobbin.

The thread is not passed through the bobbin winding thread guide correctly.	37
Bobbin spins slowly.	38
The thread that was pulled out was not wound onto the bobbin correctly.	37
The empty bobbin was not set on the pin properly.	36

While winding the bobbin, the bobbin thread was wound below the bobbin winder seat.

You have not wound the bobbin thread properly when you initially wound thread on the bobbin. Ensure that the bobbin thread was properly set in the guides.	36
--	----

Symptom, Cause/solution	Reference
The bobbin thread cannot be pulled up.	
Needle is turned, bent or the point is dull.	48
Bobbin is set incorrectly.	40
Machine does not operate	
All keys and buttons have been locked by  .	48, 50
Nothing appears in the LCD.	
Main power switch is not turned on.	22
The plug of the power cord is not inserted into an electrical outlet.	22
The LCD screen does not look very clear.	
The brightness of the screen is not adjusted.	28
Nothing happens, even if the LCD display is pressed	
Adjust the screen.	177
The screen has been locked. <ul style="list-style-type: none"> Press either of the following keys to unlock the screen.   	—
The LCD screen is fogged up.	
Condensation has formed on the LCD screen. <ul style="list-style-type: none"> After a while, the cloudiness will disappear. 	—
Embroidery unit does not operate.	
Embroidery unit is not attached correctly.	107
Embroidery frame was attached before the unit was initialized.	107
Pointer of the embroidery foot “W+” with LED pointer does not indicate the position correctly	
With thick elastic fabric, the position will be misaligned only at raised parts in the fabric.	131
With fabric having a very uneven surface, the position is not correctly aligned. <ul style="list-style-type: none"> The pointer indication should be used only as a reference. 	—

■ While Operating

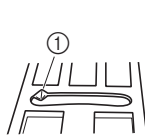
Symptom, Cause/solution	Reference
Machine does not operate.	
“Start/Stop” button was not pressed.	13
Presser foot is not lowered.	13
“Start/Stop” button was pressed with the foot controller attached.	58
The “Start/Stop” button was pressed while the machine is set for the sewing speed controller to control the zigzag stitch width.	27, 58
Needle breaks.	
Needle is installed incorrectly.	48
Needle clamp screw is not tightened.	48
Needle is turned or bent.	48
Using improper needle or thread for the selected fabric.	49
Wrong presser foot.	194
Upper thread tension is too tight.	62, 143
Fabric is pulled during sewing.	—
Spool cap is set incorrectly.	42
There are scratches around the opening in the needle plate. * There is a notch on the left side of the opening in the needle plate. This is not a scratch.	*
 ① Notch	
There are scratches around the opening in the presser foot.	*
There are scratches on the bobbin case.	*
Needle is defective.	48
A bobbin designed specifically for this machine is not being used.	36
Upper threading is incorrect.	42
Bobbin is set incorrectly.	40
Presser foot is attached incorrectly.	50
Screw of the presser foot holder is loose.	50
Fabric is too thick.	69
Fabric is fed forcefully when sewing thick fabric or thick seams.	69
Stitch length is too short.	62
Stabilizer is not attached to fabric being embroidered.	127

Symptom, Cause/solution	Reference
Bobbin thread is incorrectly wound.	36

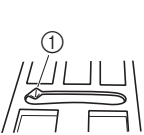
Upper thread breaks.	
Machine is not threaded correctly (used the wrong spool cap, spool cap is loose, the thread did not catch the needle bar threader, etc.)	42
Knotted or tangled thread is being used.	—
The selected needle is not appropriate for the thread being used.	49
Upper thread tension is too tight.	62, 143
Thread is twisted.	—
Needle is turned, bent or the point is dull.	48
Needle is installed incorrectly.	48
There are scratches around the opening of the needle plate. * There is a notch on the left side of the opening in the needle plate. This is not a scratch.	*
 ① Notch	
There are scratches around the opening in the presser foot.	*
There are scratches on the bobbin case.	*
Using improper needle or thread for the selected fabric.	49
A bobbin designed specifically for this machine is not being used.	36
Thread is weak, dry rotted, or of poor quality.	—

The thread is tangled on the wrong side of the fabric.	
Upper threading is incorrect.	42
Using improper needle or thread for the selected fabric.	49

The upper thread is too tight.	
The bobbin thread is incorrectly installed.	40

Bobbin thread breaks.	
Bobbin is set incorrectly.	40
Bobbin thread is incorrectly wound.	36
There are scratches on the bobbin or it doesn't rotate properly.	40
Thread is twisted.	—

Symptom, Cause/solution	Reference
A bobbin designed specifically for this machine is not being used.	36

Fabric puckers.	
There is a mistake in the upper or bobbin threading.	40, 42
Spool cap is set incorrectly.	42
Using improper needle or thread for the selected fabric.	49
Needle is turned, bent or the point is dull.	48
Stitches are too long when sewing thin fabrics.	62
Thread tension is set incorrectly.	62, 143
Wrong presser foot.	194
Fabric and stabilizer are not taut in the embroidery frame.	128
Incorrect or insufficient stabilizer is being used.	127

The stitch is not sewn correctly.	
The presser foot that is used is not appropriate for the type of stitch that you wish to sew.	194
The thread tension is incorrect.	62
The thread is tangled, for example, in the bobbin case.	176

Skipped stitches	
Machine is threaded incorrectly.	42
Using improper needle or thread for the selected fabric.	49
Needle is turned, bent or the point is dull.	48
Needle is installed incorrectly.	48
Needle is defective.	48
Dust or lint has collected under the needle plate.	176
Thin or stretch fabrics are being used.	70

No stitching	
Needle is turned, bent or the point is dull.	48
Bobbin is set incorrectly.	40
Upper threading is incorrect.	42

High-pitched sound while sewing	
Needle is turned, bent or the point is dull.	48
Dust or lint is caught in the feed dogs.	176
Pieces of thread are caught in the race.	176

Symptom, Cause/solution	Reference
Upper threading is incorrect.	42
A bobbin designed specifically for this machine is not being used.	36
There are needle holes or friction scratches in the bobbin case.	176

Fabric does not feed through the machine.	
Feed dogs are set in the down position.	80
<ul style="list-style-type: none"> Press , and then turn the handwheel to raise the feed dogs. 	
Stitches are too close together.	62
Wrong presser foot.	194
Needle is turned, bent or the point is dull.	48
Thread is entangled.	180
Zigzag foot "J" is slanted on a thick seam at the beginning of stitching.	69

The fabric feeds in the opposite direction.	
The feed mechanism is damaged.	*

The needle contacts the needle plate.	
The needle clamp screw is loose.	48
Needle is turned, bent or the point is dull.	48

Fabric being sewn with the machine cannot be removed.	
Thread is tangled below the needle plate.	179

A broken needle has fallen into the machine.	
<ul style="list-style-type: none"> Turn off the machine, and then remove the needle plate. If the needle that fell into the machine can be seen, use tweezers to remove it. After removing the needle, return the needle plate to its original position. Before turning on the machine, slowly turn the handwheel toward you to check that it turns smoothly. If the handwheel does not turn smoothly or the needle that fell into the machine cannot be removed, consult your authorized Brother dealer. 	180

The handwheel feels sluggish when it is turned.	
Thread is tangled in the bobbin case.	179

■ After Finishing an Operation

Symptom, Cause/solution	Reference
Thread tension is incorrect.	
Upper threading is incorrect.	42
Bobbin is set incorrectly.	40
Using improper needle or thread for the selected fabric.	49
Presser foot holder is not attached correctly.	50
Thread tension is set incorrectly.	62, 143
Bobbin thread is incorrectly wound.	36
Needle is turned, bent or the point is dull.	48
A bobbin designed specifically for this machine is not being used.	36







Character or decorative stitch patterns are misaligned.	
Stitch pattern adjustment settings were set incorrectly.	97















Stitch pattern does not turn out.	
Wrong presser foot.	194
Did not use a stabilizer material on thin fabrics or stretch fabrics.	70
Thread tension is set incorrectly.	62, 143
Fabric was pulled, pushed or fed at an angle while it was being sewn.	56
<ul style="list-style-type: none"> Sew while guiding the fabric with your hands so that the fabric is fed in a straight line. 	
The thread is tangled, for example, in the bobbin case.	179





Symptom, Cause/solution	Reference
The pattern is not embroidered correctly.	
Thread is twisted.	—
Thread tension is set incorrectly.	62, 143
Fabric was not inserted into the frame correctly (fabric was loose, etc.).	128
Stabilizing material was not attached. <ul style="list-style-type: none"> Always use stabilizing material, especially with stretch fabrics, lightweight fabrics, fabrics with a coarse weave, or fabrics that often cause pattern shrinkage. See your authorized Brother dealer for the proper stabilizer. 	127
There was an object placed near the machine, and the carriage or embroidery frame hit the object during embroidering.	107
Fabric outside the frame edges interferes with the arm, so the embroidery unit cannot move. <ul style="list-style-type: none"> Reinsert the fabric in the embroidery frame so that the excess fabric is away from the arm, and rotate the pattern 180 degrees. 	128
Fabric is too heavy, so the embroidery unit cannot move freely. <ul style="list-style-type: none"> Place a large thick book or similar object under the arm head to lightly lift the heavy side and keep it level. 	—
Fabric is hanging off the table. <ul style="list-style-type: none"> If the fabric is hanging off the table during embroidery, the embroidery unit will not move freely. Place the fabric so that it does not hang off the table or hold the fabric to keep it from dragging. 	135
Fabric is snagged or caught on something. <ul style="list-style-type: none"> Stop the machine and place the fabric so that it does not get caught or snagged. 	—
Embroidery frame was removed during embroidering (for example, to reset the bobbin). The presser foot was bumped or moved while removing or attaching the embroidery frame, or the embroidery unit was moved.	138
Stabilizer is incorrectly attached, for example, it is smaller than the embroidery frame.	127
Loops appear on the surface of the fabric when embroidering	
The thread tension is incorrectly set.	143
The tension of the upper thread is incorrectly set for the combination of the fabric, thread and pattern being used. <ul style="list-style-type: none"> Use the embroidery needle plate cover. 	135
The combination of the bobbin case and bobbin thread is incorrect.	134

ERROR MESSAGES

Below is an explanation of error messages. Refer to these when necessary (if you press  or do the operation correctly while the error message is displayed, the message disappears).

	Error messages	Cause/solution
1	Attach the embroidery frame.	This message is displayed when the machine is ready to embroider pattern, and the "Start/Stop" button is pushed while the embroidery frame is not attached.
2	Cannot change the configuration of the characters.	This message is displayed when there are too many characters and the curved character configuration is impossible.
3	Cannot embroider since the embroidery unit is not attached. Turn off the machine, and then attach the embroidery unit.	This message is displayed when the "Start/Stop" button is pushed and the machine is in embroidery mode, but the embroidery unit is not attached.
4	Cannot recognize the data for the selected pattern. The data may be corrupted.	This message is displayed when there is a possibility that the data for the selected embroidery pattern is corrupted.
5	Change to a larger embroidery frame.	This message is displayed when the machine is in embroidery mode and the small frame is attached, and the selected pattern does not fit in the small frame.
6	Check and rethread the upper thread.	This message is displayed when the upper thread is broken or not threaded correctly, and the "Start/Stop" button,  (reverse stitch button) or  (reinforcement stitch button) is pressed.
7	Data volume is too large for this pattern.	This message is displayed when the stitch patterns you are editing take up too much memory, or if you are editing too many stitch patterns for the memory.
8	Failed to save file.	This message appears when you try to save more than 100 settings screen image files in the USB media. In this case, delete a file from the USB media or use different USB media.
9	In twin needle mode, the automatic needle threading button cannot be used.	This message is displayed when the automatic needle threading button is pushed while twin needle mode is selected.
10	Includes a special pattern that cannot be saved to external memory. Save the pattern in the machine's memory.	This message is displayed when you try to save a copyright protected pattern to USB media. According to copyright laws, patterns that are illegal to reproduce or edit cannot be saved to USB media. If this message displays, save the pattern in the machine's memory.
11	Lower the buttonhole lever.	This message is displayed when the buttonhole lever is up, a buttonhole stitch is selected, and the "Start/ Stop" button,  (reverse stitch button) or  (reinforcement stitch button) is pushed.
12	Lower the presser foot lever.	This message is displayed when  (Presser foot lifter button) is pushed while the presser foot lever is raised/the needle is lowered.
13	Make sure embroidery frame is moved as far back as possible. LOCK DOWN THE FRAME-SECURING LEVER.	This message is displayed when the embroidery frame is attached.
14	No more patterns can be added to this combination.	This message is displayed when you cannot combine patterns.
15	No more stitches can be combined.	This message is displayed when you try to combine more than 71 patterns.
16	Not enough available memory to save the data. Delete some patterns or use a different media.	This message is displayed when the memory is full and the stitch pattern or embroidery pattern cannot be saved.
17	Not enough available memory to save the pattern. Delete another pattern?	This message is displayed when the memory is full and the stitch pattern or embroidery pattern cannot be saved.
18	OK to cancel the current pattern selection?	This message is displayed when, after selecting a pattern,  is pressed and the pattern is about to be deleted.

	Error messages	Cause/solution
19	OK to cancel the current stitch selection?	This message is displayed when, after selecting a stitch pattern,  ,  , or  is pressed and the stitch pattern is about to be deleted.
20	OK to delete the selected picture?	This message is displayed when the image is deleted.
21	OK to delete the setting?	This message appears when  or  is pressed to delete the settings for a utility stitch. To delete the selected settings, press  .
22	OK to move the embroidery carriage to its previous position?	This message is displayed when replacing the embroidering bobbin thread.
23	OK to recall and resume previous memory?	This message appears if the machine is turned off while embroidering, then turned on again. Press  to return the machine to the condition (pattern position and number of stitches) when it was turned off. Follow the procedure described in "If the Thread Breaks or the Bobbin Runs out of Thread During Embroidering" on page 138 to align the needle position and embroider the remainder of the pattern.
24	OK to revert to previous color changes?	This message is displayed when  is pressed when changing thread colors.
25	OK to separate the combined border pattern?	This message is displayed when rotating a saved combined pattern in the embroidery screen.
26	Pattern extends to the outside of embroidery frame.	This message is displayed when the machine is in embroidery mode, and the character pattern combination is too large to fit in the embroidery frame.
27	Pattern extends to the outside of embroidery frame. If you plan to add more patterns, rotate the pattern combination.	This message is displayed when the machine is in embroidery mode and the combined character pattern is too large for the embroidery frame. You can rotate the pattern 90 degrees and continue combining characters.
28	Preventive maintenance is recommended.	This message is displayed when the machine needs to be maintained. Once this message appears, it is recommended to take your machine to an authorized Brother dealer or the nearest Brother authorized service center for a regular maintenance check. Although this message will disappear and the machine will continue to function once you press  , the message will display several more times until the appropriate maintenance is performed.
29	Raise the buttonhole lever.	This message is displayed when the buttonhole lever is down, a stitch other than a buttonhole is selected, and the "Start/ Stop" button,  (reverse stitch button) or  (reinforcement stitch button) is pushed.
30	Remove Dual Feed module from the machine.	This message appears when you try to start embroidering with the dual feed foot attached to the machine. Remove the dual feed foot before entering the embroidery mode.
31	Remove Embroidery foot with LED pointer from the machine.	This message appears when you try to start sewing utility stitches or character/decorative stitches with the embroidery foot with the LED pointer attached to the machine. Remove the embroidery foot with the LED pointer before entering the sewing mode.
32	Select a pattern.	This message is displayed when there is no embroidery pattern selected and the "Start/Stop" button,  (reverse stitch button) or  (reinforcement stitch button) is pressed.
33	Select a stitch.	This message is displayed when there is no stitch pattern selected and the "Start/Stop" button,  (reverse stitch button) or  (reinforcement stitch button) is pressed.
34	Set the clock.	This message appears when the time/date is not set. Set time/date. (page 22)
35	The "Start/Stop" button does not operate with the foot controller attached. Remove the foot controller.	This message is displayed when the "Start/Stop" button is pushed to sew Utility stitches or Character/Decorative stitches while the foot controller is connected. (This message does not appear when embroidering).

	Error messages	Cause/solution
36	The bobbin thread is almost empty.	This message is displayed when the bobbin thread is running out. Although a few stitches can be sewn when the "Start/Stop" button is pressed, replace with a wound bobbin immediately. When embroidering, press  , press  , remove the embroidery frame, and then replace the bobbin with one wound with plenty of embroidery bobbin thread. If [Upper and Bobbin Thread Sensor] in the general settings screen of the machine setting mode is set to [OFF], this message does not appear.
37	The bobbin winder safety device has activated. Is the thread tangled?	This message is displayed when the bobbin is being wound, and the motor locks because the thread is tangled, etc.
38	The carriage of the embroidery unit will move. Keep your hands etc. away from the carriage.	This message is displayed when the embroidery unit is initializing.
39	The safety device was activated since the main shaft motor was heated. Is the thread tangled?	This message is displayed when the temperature of the motor increases, activating the safety device. Wait until the temperature decreases. If the error persists, contact your nearest authorized Brother dealer.
40	The safety device was activated since the main shaft motor seized. Is the thread tangled?	This message is displayed when the motor locks due to tangled thread or for other reasons related to thread delivery.
41	The safety device was activated since the needle position sensor malfunctioned.	This message is displayed when an error in the needle position sensor is detected, activating the safety device. Turn the machine off, then on again. If the message continues to appear, the machine may be damaged. Contact your nearest authorized Brother dealer.
42	The upper thread may not be threaded correctly. Thread the upper thread from the beginning.	This message is displayed when it seems that the upper thread has not been threaded correctly.
43	The USB media was changed. Do not change the USB media while it is being read.	This message is displayed when you attempt to select a stitch pattern after the USB media in which the stitch pattern is saved has been changed.
44	There is no needle plate cover. Attach a needle plate cover.	This message is displayed when the needle plate cover is not attached.
45	This editing function cannot be used when the pattern is out of the red outline. Use this function after moving the pattern.	This message is displayed when the machine is in embroidery edit mode, and you try to use an editing function when the pattern is not completely within the red outline.
46	This file cannot be used.	This message appears if the file format is incompatible with this machine. Check the list of compatible file formats. (page 192)
47	This file exceeds the data capacity and cannot be used. Use a suitable size file.	This message is displayed when the file size exceeds the data capacity of the machine. Confirm the file size and format. (page 192)
48	This key cannot be used at this time.	This message is displayed when you press  in the screen other than the Utility Stitch, or press  in the screen other than the Utility Stitch or Character/Decorative Stitch.
49	This key does not operate when the needle is down. Raise the needle and press the key again.	This message is displayed when a key on the LCD display is touched while the needle is in the down position.
50	This stitch is not "Dual Feed Mode" compatible.	This message appears when the dual feed foot cannot be used with the current stitch. Select other stitch.
51	This USB media cannot be used.	This message is displayed when you try to use incompatible media.
52	This USB media is incompatible.	This message is displayed when you try to use incompatible USB media. For a list of compatible USB media, visit " http://s.brother/cpeaa/ ".
53	Turn off the machine before attaching or removing the needle plate.	This message is displayed when the regular needle plate is replaced with the straight stitch needle plate while the machine is ON.
54	Turn off the power and replace the needle plate.	<ul style="list-style-type: none"> This message is displayed when the machine is set to embroidery mode or utility decorative stitch mode from the home page screen while the straight stitch needle plate or no needle plate is installed. This message is displayed when the straight stitch needle plate is installed while a stitch pattern that cannot be used with that needle plate is selected.
55	USB media error	This message is displayed when an error occurs with the USB media.

	Error messages	Cause/solution
56	Use the presser foot lifter button to lower the presser foot.	This message is displayed when a button, such as the "Start/Stop" button, is pushed while the presser foot is raised.
57	Use the presser foot lifter button to raise the presser foot.	This message is displayed when the embroidery unit is attached and the power is turned on with the needle in the down position.
58	When the speed controller is set to control the zigzag stitch width, the "Start/Stop" button does not operate.	This message is displayed when the speed control lever is set to control the zigzag stitch width, and the "Start/ Stop" button is pushed. Use the foot controller to operate the machine.

■ **Alarm Sounds**

If the operation was performed incorrectly, an alarm sounds to indicate that an error occurred. If the operation was performed correctly, the machine beeps to confirm the operation.

 **Memo**

- To cancel the operation beep or to change the volume, press  and then change the setting for [Machine Speaker Volume]. Refer to page 28 for more details.

SPECIFICATIONS

		Item	Specification
Size and Weight	Machine (Box 1 of 2)	Dimensions of machine	Approx. 662 mm (W) × 348 mm (H) × 321 mm (D) (approx. 26-1/16 inches (W) × 13-11/16 inches (H) × 12-5/8 inches (D))
		Dimensions of box	Approx. 740 mm (W) × 620 mm (H) × 405 mm (D) (approx. 29-1/8 inches (W) × 24-13/32 inches (H) × 15-15/16 inches (D))
		Weight of machine	Approx. 17 kg (approx. 37.5 lb)
		Weight of box (for shipping)	Approx. 26.5 kg (approx. 58.4 lb)
		Sewing speed	70 to 1050 stitches per minute
		Needles	Home sewing machine needles (HA × 130)
	Embroidery Unit (Box 2 of 2)	Dimensions of embroidery unit	Approx. 595 mm (W) × 139 mm (H) × 524 mm (D) (approx. 23-7/16 inches (W) × 5-15/32 inches (H) × 20-5/8 inches (D))
		Dimensions of machine with embroidery unit attached	Approx. 916 mm (W) × 348 mm (H) × 524 mm (D) (approx. 36-1/16 inches (W) × 13-11/16 inches (H) × 20-5/8 inches (D))
		Dimensions of box	Approx. 735 mm (W) × 620 mm (H) × 190 mm (D) (approx. 28-15/16 inches (W) × 24-13/32 inches (H) × 7-15/32 inches (D))
		Weight of embroidery unit	Approx. 4.6 kg (approx. 10.1 lb)
		Weight of box (for shipping)	Approx. 7.1 kg (approx. 15.7 lb)
Total Shipping Weight (Combination of all 2 boxes complete)		Approx. 34.5 kg (approx. 76.1 lb)	
Data Precaution	Memory	Stitch patterns	1 MB
		Embroidery patterns	10 MB
		Images can be imported to the machine (My Design Center)	100 MB
	Data Types	Stitch patterns ^{*1}	.pmv .pmx .pmu .pmi
		Embroidery patterns ^{*2}	.pes .phc .phx .dst .pen
		Data that can be loaded when using My Design Center	.jpg .png .bmp
	Types of USB Devices/ Media that can be Used ^{*3}	Stitch patterns	Stitch data can be saved to or recalled from USB external media. Use external media that meets the following specifications. <ul style="list-style-type: none"> • USB Flash drive (USB Flash memory) • USB Floppy disk drive Stitch data can be recalled only from; <ul style="list-style-type: none"> • USB CD-ROM, CD-R, CD-RW drives You can also use the following types of USB media with the USB Memory Card Reader/USB card writer module. <ul style="list-style-type: none"> • Secure Digital (SD) Card • CompactFlash • Memory Stick • Smart Media • Multi Media Card (MMC) • xD-Picture Card
		Embroidery patterns	Embroidery data can be saved to or recalled from USB media. Use media that meets the following specifications. <ul style="list-style-type: none"> • USB Flash drive (USB Flash memory) Embroidery data can be recalled only. <ul style="list-style-type: none"> • USB CD-ROM, CD-R, CD-RW drives You can also use the following types of USB media with the USB Memory Card Reader/USB card writer module. <ul style="list-style-type: none"> • Secure Digital (SD) Card • CompactFlash • Memory Stick • Smart Media • Multi Media Card (MMC) • xD-Picture Card

		Item		Specification
Condition of the [Eco Mode] and [Shutoff Support Mode]	[Eco Mode]	Available time	OFF, 10 - 120 (minute)	
		“Start/Stop” button	Green flashing	
		Suspended function	Machine light, Screen display, LED pointer, Guideline marker	
		After recovering	The machine starts from the previous operation.	
	[Shutoff Support Mode]	Available time	OFF, 1 - 12 (hour)	
		“Start/Stop” button	Green slow flashing	
		Suspended function	All functions	
		After recovering	An error message appears. You need to turn off and on the machine to restart.	
Compatible image files of the Screen Saver Image	Format	JPEG format (.jpg)		
	File size	Max. 150 KB for each image		
	File dimension	1280 × 1280 pixels or less (If the width is between 800 and 1279 pixels, the image will be displayed at 800 pixels.)		
	Number allowed	5 or less		
Videos that can be played	MP4 file format	Video - H.264/MPEG-4 AVC, Audio – AAC		
	Size	450 (H) × 800 (W)		
	Maximum file size	1 GB		

*1 “.pmu” stitch data files can be retrieved; however, when the machine is used to save the file, it is saved as a “.pmv” stitch data file. Using data other than that created using this machine or the machine which create “.pmu” data file, may cause the machine to malfunction.

*2

- Using data other than that saved using our data design systems or this machine may cause this machine to malfunction. When the machine is used to save a file with any extension, it is saved as a .phx data file.
- .dst data is displayed in the pattern list screen by file name (the actual image cannot be displayed). The full file name may not be displayed depending on the number of characters in the file name. Since Tajima (.dst) data does not contain specific thread color information, it is displayed with our default thread color sequence. Check the preview and change the thread colors as desired.

*3

- USB media is commercially available, but some USB media may not be usable with this machine. Please visit our website “ <http://s.brother/cpeaa/> ” for more details.
- Depending on the type of USB devices/media being used, either directly plug the USB device into the machine’s USB port or plug the USB media Reader/Writer into the machine’s USB port.

* Please be aware that some specifications may change without notice.

CAUTION

- When using embroidery data other than our original patterns, the thread or needle may break when embroidering with a stitch density that is too fine or when embroidering three or more overlapping stitches. In that case, use one of our original data design systems to edit the embroidery data.

UPGRADING YOUR MACHINE'S SOFTWARE

You can use USB media to upgrade software for your machine.

When an upgrade program is available on "<http://s.brother/cpeaa/>", please download the files following the instructions on the website and steps below.

Note

- When using USB media to upgrade the software, check that no data other than the upgrade file is saved on the USB media being used before starting to upgrade.

1 While pressing  (Automatic threading button), turn the main power to ON.

2 Press .



3 Insert the USB media into the primary (top) USB port on the machine.

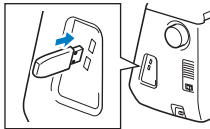

4 Press .

→ When upgrading is finished, the completion message appears.

5 Turn the machine off, remove the USB media, and turn the machine on again.

STITCH SETTING CHART

Memo

- When any of the following stitches (reverse stitch patterns and reinforcement stitch patterns) are selected, pressing  (Reverse stitch button) will sew reverse stitches.

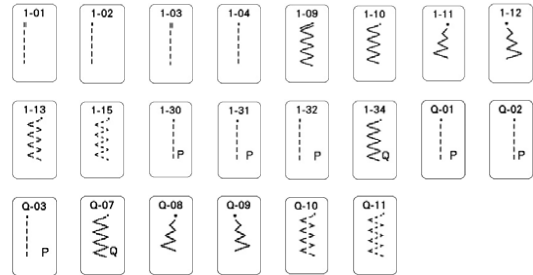

When any other stitch is selected, pressing  (Reverse stitch button) will sew reinforcement stitches.

- The stitch pattern symbols indicate the following.

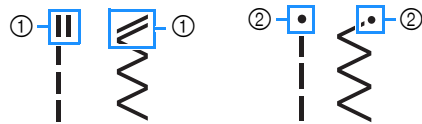





















- ① Reverse stitch pattern
- ② Reinforcement stitch pattern















Note

















- The presser foot that is displayed on each screen when Free motion mode is OFF/ON is shown in the table under "Presser foot".



















* Twin needle can be used by attaching zigzag foot "J".

















Stitch	Presser foot	Stitch name/ Applications	Stitch width (mm (inch))	Stitch length (mm (inch))
			Auto. Manual	Auto. Manual
	J*/O	Straight stitch (Left) General sewing, gather, pintuck, etc.	0.0 (0) 0.0 - 7.0 (0 - 1/4)	2.5 (3/32) 0.2 - 5.0 (1/64 - 3/16)
	J*/O	Straight stitch (Left) General sewing, gather, pintuck, etc.	0.0 (0) 0.0 - 7.0 (0 - 1/4)	2.5 (3/32) 0.2 - 5.0 (1/64 - 3/16)
	J*/O	Straight stitch (Middle) General sewing, gather, pintuck, etc.	3.5 (1/8) 0.0 - 7.0 (0 - 1/4)	2.5 (3/32) 0.2 - 5.0 (1/64 - 3/16)
	J*/O	Straight stitch (Middle) General sewing, gather, pintuck, etc.	3.5 (1/8) 0.0 - 7.0 (0 - 1/4)	2.5 (3/32) 0.2 - 5.0 (1/64 - 3/16)
	J*/O	Triple stretch stitch General sewing for reinforcement and decorative topstitching	0.0 (0) 0.0 - 7.0 (0 - 1/4)	2.5 (3/32) 0.4 - 5.0 (1/64 - 3/16)

















Stitch	Presser foot	Stitch name/ Applications	Stitch width (mm (inch))	Stitch length (mm (inch))
			Auto. Manual	Auto. Manual
	J*/O	Stem stitch Reinforced stitching, sewing and decorative applications	1.0 (1/16) 0.0 - 7.0 (0 - 1/4)	2.5 (3/32) 0.4 - 5.0 (1/64 - 3/16)
	N*/O	Decorative stitch Decorative stitching, top stitching	0.0 (0) 0.0 - 7.0 (0 - 1/4)	2.5 (3/32) 0.4 - 5.0 (1/64 - 3/16)
	J/O	Basting stitch For basting.	0.0 (0) 0.0 - 7.0 (0 - 1/4)	20 (3/4) 5 - 30 (3/16 - 1-1/4)
	J*/O	Zigzag stitch For overcasting, mending.	3.5 (1/8) 0.0 - 7.0 (0 - 1/4)	1.4 (1/16) 0.0 - 5.0 (0 - 3/16)
	J*/O	Zigzag stitch For overcasting, mending.	3.5 (1/8) 0.0 - 7.0 (0 - 1/4)	1.4 (1/16) 0.0 - 5.0 (0 - 3/16)
	J*/O	Zigzag stitch (Right) Start from right needle position, zigzag sew at left.	3.5 (1/8) 2.5 - 5.0 (3/32 - 3/16)	1.4 (1/16) 0.3 - 5.0 (1/64 - 3/16)
	J*/O	Zigzag stitch (Left) Start from left needle position, zigzag sew at right.	3.5 (1/8) 2.5 - 5.0 (3/32 - 3/16)	1.4 (1/16) 0.3 - 5.0 (1/64 - 3/16)
	J*/O	2 steps elastic zigzag Overcasting (medium weight and stretch fabrics), tape and elastic	5.0 (3/16) 0.0 - 7.0 (0 - 1/4)	1.0 (1/16) 0.2 - 5.0 (1/64 - 3/16)
	J*/O	2 steps elastic zigzag Overcasting (medium weight and stretch fabrics), tape and elastic	5.0 (3/16) 0.0 - 7.0 (0 - 1/4)	1.0 (1/16) 0.2 - 5.0 (1/64 - 3/16)
	J*/O	3 steps elastic zigzag Overcasting (medium, heavyweight and stretch fabrics), tape and elastic	5.0 (3/16) 0.0 - 7.0 (0 - 1/4)	1.0 (1/16) 0.2 - 5.0 (1/64 - 3/16)
	G	Overcasting stitch Reinforcing of light and medium weight fabrics	3.5 (1/8) 2.5 - 5.0 (3/32 - 3/16)	2.0 (1/16) 0.4 - 5.0 (1/64 - 3/16)
	G	Overcasting stitch Reinforcing of heavyweight fabric	5.0 (3/16) 2.5 - 5.0 (3/32 - 3/16)	2.5 (3/32) 0.4 - 5.0 (1/64 - 3/16)
	G	Overcasting stitch Reinforcing of medium, heavyweight and easily friable fabrics or decorative stitching.	5.0 (3/16) 3.5 - 5.0 (1/8 - 3/16)	2.5 (3/32) 0.4 - 5.0 (1/64 - 3/16)
	J*/O	Overcasting stitch Reinforced seaming of stretch fabric	5.0 (3/16) 0.0 - 7.0 (0 - 1/4)	2.5 (3/32) 0.4 - 5.0 (1/64 - 3/16)
	J*/O	Overcasting stitch Reinforcing of medium stretch fabric and heavyweight fabric, decorative stitching	5.0 (3/16) 0.0 - 7.0 (0 - 1/4)	2.5 (3/32) 0.4 - 5.0 (1/64 - 3/16)
	J*/O	Overcasting stitch Reinforcement of stretch fabric or decorative stitching	4.0 (3/16) 0.0 - 7.0 (0 - 1/4)	4.0 (3/16) 0.4 - 5.0 (1/64 - 3/16)















Stitch	Presser foot	Stitch name/ Applications	Stitch width (mm (inch))	Stitch length (mm (inch))
			Auto. Manual	Auto. Manual
	J/O	Overcasting stitch Stretch knit seam	5.0 (3/16) 0.0 - 7.0 (0 - 1/4)	4.0 (3/16) 0.4 - 5.0 (1/64 - 3/16)
	J*/O	Single diamond overcast Reinforcement and seaming stretch fabric	6.0 (15/64) 0.0 - 7.0 (0 - 1/4)	3.0 (1/8) 0.4 - 5.0 (1/64 - 3/16)
	J*/O	Single diamond overcast Reinforcement of stretch fabric	6.0 (15/64) 0.0 - 7.0 (0 - 1/4)	1.8 (1/16) 0.4 - 5.0 (1/64 - 3/16)
	S	With side cutter Straight stitch while cutting fabrics	0.0 (0) 0.0 - 2.5 (0 - 3/32)	2.5 (3/32) 0.2 - 5.0 (1/64 - 3/16)
	S	With side cutter Zigzag stitch while cutting fabrics	3.5 (1/8) 3.5 - 5.0 (1/8 - 3/16)	1.4 (1/16) 0.0 - 5.0 (0 - 3/16)
	S	With side cutter Overcasting stitch while cutting fabrics	3.5 (1/8) 3.5 - 5.0 (1/8 - 3/16)	2.0 (1/16) 0.4 - 5.0 (1/64 - 3/16)
	S	With side cutter Overcasting stitch while cutting fabrics	5.0 (3/16) 3.5 - 5.0 (1/8 - 3/16)	2.5 (3/32) 0.4 - 5.0 (1/64 - 3/16)
	S	With side cutter Overcasting stitch while cutting fabrics	5.0 (3/16) 3.5 - 5.0 (1/8 - 3/16)	2.5 (3/32) 0.4 - 5.0 (1/64 - 3/16)
	J/O	Piecing stitch (Right) Piecework/patchwork 6.5 mm (approx. 1/4 inch) right seam allowance	5.5 (7/32) 0.0 - 7.0 (0 - 1/4)	2.0 (1/16) 0.2 - 5.0 (1/64 - 3/16)
	J/C	Piecing stitch (Middle) Piecework/patchwork	—	2.0 (1/16) 0.2 - 5.0 (1/64 - 3/16)
	J/O	Piecing stitch (Left) Piecework/patchwork 6.5 mm (approx. 1/4 inch) left seam allowance	1.5 (1/16) 0.0 - 7.0 (0 - 1/4)	2.0 (1/16) 0.2 - 5.0 (1/64 - 3/16)
	J/O	Hand-look quilting Quilting stitch made to look like hand quilting when using transparent nylon thread for the upper thread and a thread color matching the quilt for the bobbin thread. Sew with a tight thread tension so that the bobbin thread is visible from the right side of the fabric. Use a needle between 90/ 14 and 100/16.	0.0 (0) 0.0 - 7.0 (0 - 1/4)	2.5 (3/32) 0.4 - 5.0 (1/64 - 3/16)
	J/O	Quilting appliqué zigzag stitch Zigzag stitch for quilting and sewing on appliqué quilt pieces	3.5 (1/8) 0.0 - 7.0 (0 - 1/4)	1.4 (1/16) 0.0 - 5.0 (0 - 3/16)
	J/O	Quilting appliqué stitch Quilting stitch for invisible appliqué or attaching binding	1.5 (1/16) 0.0 - 7.0 (0 - 1/4)	1.8 (1/16) 0.4 - 5.0 (1/64 - 3/16)

















Stitch	Presser foot	Stitch name/ Applications	Stitch width (mm inch))	Stitch length (mm inch))
			Auto. Manual	Auto. Manual
	J/O	Quilting stippling Background quilting	7.0 (1/4) 0.0 - 7.0 (0 - 1/4)	1.6 (1/16) 0.4 - 5.0 (1/64 - 3/16)
	R	Blind hem stitch Hemming woven fabrics * The stitch width setting is in neither millimeters nor inches.	00 3← -->3	2.0 (1/16) 0.4 - 5.0 (1/64 - 3/16)
	R	Blind hem stitch stretch Hemming stretch fabric * The stitch width setting is in neither millimeters nor inches.	00 3← -->3	2.0 (1/16) 0.4 - 5.0 (1/64 - 3/16)
	J*/O	Blanket stitch Appliqués, decorative blanket stitch	3.5 (1/8) 0.0 - 7.0 (0 - 1/4)	2.5 (3/32) 0.4 - 5.0 (1/64 - 3/16)
	J*/O	Blanket stitch Appliqués, decorative blanket stitch	2.5 (3/32) 0.0 - 7.0 (0 - 1/4)	2.5 (3/32) 0.4 - 5.0 (1/64 - 3/16)
	J*/O	Shell tuck edge Shell tuck edge finish on fabrics	4.0 (3/16) 0.0 - 7.0 (0 - 1/4)	2.5 (3/32) 0.2 - 5.0 (1/64 - 3/16)
	N*/O	Satin scallop stitch Decorating collar of blouse, edge of handkerchief	5.0 (3/16) 0.0 - 7.0 (0 - 1/4)	0.5 (1/32) 0.1 - 5.0 (1/64 - 3/16)
	N/O	Scallop stitch Decorating collar of blouse, edge of handkerchief	7.0 (1/4) 0.0 - 7.0 (0 - 1/4)	1.4 (1/16) 0.4 - 5.0 (1/64 - 3/16)
	J*/O	Patchwork join stitch Patchwork stitches, decorative stitching	4.0 (3/16) 0.0 - 7.0 (0 - 1/4)	1.2 (1/16) 0.2 - 5.0 (1/64 - 3/16)
	J*/O	Patchwork double overlock stitch Patchwork stitches, decorative stitching	5.0 (3/16) 0.0 - 7.0 (0 - 1/4)	2.5 (3/32) 0.4 - 5.0 (1/64 - 3/16)
	J*/O	Couching stitch Decorative stitching, attaching cord and couching	5.0 (3/16) 0.0 - 7.0 (0 - 1/4)	1.2 (1/16) 0.2 - 5.0 (1/64 - 3/16)
	J*/O	Smocking stitch Smocking, decorative stitching	5.0 (3/16) 0.0 - 7.0 (0 - 1/4)	1.6 (1/16) 0.4 - 5.0 (1/64 - 3/16)
	J*/O	Feather stitch Fagoting, decorative stitching	5.0 (3/16) 0.0 - 7.0 (0 - 1/4)	2.5 (3/32) 0.4 - 5.0 (1/64 - 3/16)
	J*/O	Fagoting cross stitch Fagoting, bridging and decorative stitching	5.0 (3/16) 0.0 - 7.0 (0 - 1/4)	2.5 (3/32) 0.4 - 5.0 (1/64 - 3/16)
	J*/O	Tape attaching Attaching tape to seam in stretch fabric	4.0 (3/16) 0.0 - 7.0 (0 - 1/4)	1.0 (1/16) 0.2 - 5.0 (1/64 - 3/16)
	J/O	Ladder stitch Decorative stitching	4.0 (3/16) 0.0 - 7.0 (0 - 1/4)	3.0 (1/8) 0.4 - 5.0 (1/64 - 3/16)

















Stitch	Presser foot	Stitch name/ Applications	Stitch width (mm inch))	Stitch length (mm inch))
			Auto. Manual	Auto. Manual
	J*/O	Rick-rack stitch Decorative top stitching	4.0 (3/16) 0.0 - 7.0 (0 - 1/4)	2.5 (3/32) 0.4 - 5.0 (1/64 - 3/16)
	J*/O	Decorative stitch Decorative stitching	1.0 (1/16) 0.0 - 7.0 (0 - 1/4)	2.5 (3/32) 0.4 - 5.0 (1/64 - 3/16)
	J*/O	Decorative stitch Decorative stitching	5.5 (7/32) 0.0 - 7.0 (0 - 1/4)	1.6 (1/16) 0.4 - 5.0 (1/64 - 3/16)
	N*/O	Serpentine stitch Decorative stitching and attaching elastic	5.0 (3/16) 0.0 - 7.0 (0 - 1/4)	1.0 (1/16) 0.2 - 5.0 (1/64 - 3/16)
	N*/O	Decorative stitch Decorative stitching and appliqué	6.0 (15/64) 0.0 - 7.0 (0 - 1/4)	1.0 (1/16) 0.2 - 5.0 (1/64 - 3/16)
	N/O	Decorative stippling stitch Decorative stitching	7.0 (1/4) 0.0 - 7.0 (0 - 1/4)	1.6 (1/16) 0.4 - 5.0 (1/64 - 3/16)
	N*/O	Hemstitching Decorative hems, triple straight at left	1.0 (1/16) 0.0 - 7.0 (0 - 1/4)	2.5 (3/32) 0.4 - 5.0 (1/64 - 3/16)
	N*/O	Hemstitching Decorative hems, triple straight at center	3.5 (1/8) 0.0 - 7.0 (0 - 1/4)	2.5 (3/32) 0.4 - 5.0 (1/64 - 3/16)
	N*/O	Hemstitching zigzag Decorative hems, top stitching	6.0 (15/64) 0.0 - 7.0 (0 - 1/4)	3.0 (1/8) 0.4 - 5.0 (1/64 - 3/16)
	N/O	Hemstitching Decorative hems, lace attaching pin stitch	3.5 (1/8) 0.0 - 7.0 (0 - 1/4)	2.5 (3/32) 0.4 - 5.0 (1/64 - 3/16)
	N/O	Hemstitching Decorative hems	3.0 (1/8) 0.0 - 7.0 (0 - 1/4)	3.5 (1/8) 0.4 - 5.0 (1/64 - 3/16)
	N/O	Hemstitching Decorative hems daisy stitch	6.0 (15/64) 0.0 - 7.0 (0 - 1/4)	3.0 (1/8) 0.4 - 5.0 (1/64 - 3/16)
	N/O	Hemstitching Heirloom, decorative hems	5.0 (3/16) 0.0 - 7.0 (0 - 1/4)	3.5 (1/8) 0.4 - 5.0 (1/64 - 3/16)
	N/O	Hemstitching Heirloom, decorative hems	5.0 (3/16) 0.0 - 7.0 (0 - 1/4)	3.5 (1/8) 0.4 - 5.0 (1/64 - 3/16)
	N*/O	Hemstitching Heirloom, decorative hems	5.0 (3/16) 0.0 - 7.0 (0 - 1/4)	3.5 (1/8) 0.4 - 5.0 (1/64 - 3/16)
	N*/O	Hemstitching Heirloom, decorative hems	5.0 (3/16) 0.0 - 7.0 (0 - 1/4)	4.0 (3/16) 0.4 - 5.0 (1/64 - 3/16)
	N*/O	Hemstitching Heirloom, decorative hems	4.0 (3/16) 0.0 - 7.0 (0 - 1/4)	2.5 (3/32) 0.4 - 5.0 (1/64 - 3/16)
	N*/O	Honeycomb stitch Heirloom, decorative hems	5.0 (3/16) 0.0 - 7.0 (0 - 1/4)	2.5 (3/32) 0.4 - 5.0 (1/64 - 3/16)

Stitch	Presser foot	Stitch name/ Applications	Stitch width (mm (inch))	Stitch length (mm (inch))
			Auto. Manual	Auto. Manual
	N*/O	Honeycomb stitch Heirloom, decorative hems	6.0 (15/64) 0.0 - 7.0 (0 - 1/4)	3.5 (1/8) 0.4 - 5.0 (1/64 - 3/16)
	N*/O	Hemstitching Heirloom, decorative hems	6.0 (15/64) 0.0 - 7.0 (0 - 1/4)	1.6 (1/16) 0.4 - 5.0 (1/64 - 3/16)
	N/O	Hemstitching Heirloom, decorative hems	6.0 (15/64) 0.0 - 7.0 (0 - 1/4)	3.0 (1/8) 0.4 - 5.0 (1/64 - 3/16)
	N*/O	Hemstitching Heirloom, decorative hems	6.0 (15/64) 0.0 - 7.0 (0 - 1/4)	4.0 (3/16) 0.4 - 5.0 (1/64 - 3/16)
	N/O	Hemstitching Heirloom, decorative hems	4.0 (3/16) 0.0 - 7.0 (0 - 1/4)	2.5 (3/32) 0.4 - 5.0 (1/64 - 3/16)
	N*/O	Hemstitching Heirloom, decorative hems	5.0 (3/16) 0.0 - 7.0 (0 - 1/4)	2.0 (1/16) 0.4 - 5.0 (1/64 - 3/16)
	N*/O	Hemstitching Decorative hems and bridging stitch	6.0 (15/64) 0.0 - 7.0 (0 - 1/4)	2.0 (1/16) 0.4 - 5.0 (1/64 - 3/16)
	N*/O	Hemstitching Decorative hems. Fagoting, attaching ribbon	5.0 (3/16) 0.0 - 7.0 (0 - 1/4)	3.0 (1/8) 0.4 - 5.0 (1/64 - 3/16)
	N/O	Hemstitching Decorative hems, smocking	6.0 (15/64) 0.0 - 7.0 (0 - 1/4)	1.6 (1/16) 0.4 - 5.0 (1/64 - 3/16)
	N/O	Hemstitching Decorative hems, smocking	5.0 (3/16) 0.0 - 7.0 (0 - 1/4)	1.6 (1/16) 0.4 - 5.0 (1/16 - 3/16)
	N/O	Hemstitching Decorative hems, smocking	5.0 (3/16) 0.0 - 7.0 (0 - 1/4)	1.6 (1/16) 0.4 - 5.0 (1/64 - 3/16)
	N/O	Hemstitching Decorative hems	5.0 (3/16) 0.0 - 7.0 (0 - 1/4)	1.6 (1/16) 0.4 - 5.0 (1/64 - 3/16)
	N/O	Ladder stitch Decorative hems. Fagoting, attaching ribbon	7.0 (1/4) 0.0 - 7.0 (0 - 1/4)	1.6 (1/16) 0.4 - 2.5 (1/64 - 3/32)
	A	Narrow rounded buttonhole Buttonhole on light to medium weight fabrics	5.0 (3/16) 3.0 - 6.0 (1/8 - 15/64)	0.4 (1/64) 0.2 - 1.0 (1/64 - 1/16)
	A	Wide round ended buttonhole Buttonholes with extra space for larger buttons	5.5 (7/32) 3.5 - 6.0 (1/8 - 15/64)	0.4 (1/64) 0.2 - 1.0 (1/64 - 1/16)
	A	Tapered round ended buttonhole Reinforced waist tapered buttonholes	5.0 (3/16) 3.0 - 6.0 (1/8 - 15/64)	0.4 (1/64) 0.2 - 1.0 (1/64 - 1/16)
	A	Round ended buttonhole Buttonholes with vertical bar tack in heavyweight fabrics	5.0 (3/16) 3.0 - 6.0 (1/8 - 15/64)	0.4 (1/64) 0.2 - 1.0 (1/64 - 1/16)

Stitch	Presser foot	Stitch name/ Applications	Stitch width (mm (inch))	Stitch length (mm (inch))
			Auto. Manual	Auto. Manual
	A	Round ended buttonhole Buttonholes with bar tack	5.0 (3/16) 3.0 - 6.0 (1/8 - 15/64)	0.4 (1/64) 0.2 - 1.0 (1/64 - 1/16)
	A	Round double ended buttonhole Buttonholes for fine, medium to heavyweight fabrics	5.0 (3/16) 3.0 - 6.0 (1/8 - 15/64)	0.4 (1/64) 0.2 - 1.0 (1/64 - 1/16)
	A	Narrow squared buttonhole Buttonholes for light to medium weight fabrics	5.0 (3/16) 3.0 - 6.0 (1/8 - 15/64)	0.4 (1/64) 0.2 - 1.0 (1/64 - 1/16)
	A	Wide squared buttonhole Buttonholes with extra space for larger decorative buttons	5.5 (7/32) 3.5 - 6.0 (1/8 - 15/64)	0.4 (1/64) 0.2 - 1.0 (1/64 - 1/16)
	A	Squared buttonhole Heavy-duty buttonholes with vertical bar tacks	5.0 (3/16) 3.0 - 6.0 (1/8 - 15/64)	0.4 (1/64) 0.2 - 1.0 (1/64 - 1/16)
	A	Stretch buttonhole Buttonholes for stretch or woven fabrics	6.0 (15/64) 3.0 - 6.0 (1/8 - 15/64)	1.0 (1/16) 0.5 - 2.0 (1/32 - 1/16)
	A	Heirloom buttonhole Buttonholes for heirloom and stretch fabrics	6.0 (15/64) 3.0 - 6.0 (1/8 - 15/64)	1.5 (1/16) 1.0 - 3.0 (1/16 - 1/8)
	A	Bound buttonhole The first step in making bound buttonholes	5.0 (3/16) 0.0 - 6.0 (0 - 15/64)	2.0 (1/16) 0.2 - 4.0 (1/64 - 3/16)
	A	Keyhole buttonhole Buttonholes in heavyweight or thick fabrics for larger flat buttons	7.0 (1/4) 3.0 - 7.0 (1/8 - 1/4)	0.5 (1/32) 0.3 - 1.0 (1/64 - 1/16)
	A	Tapered keyhole buttonhole Buttonholes in medium to heavy weight fabrics for larger flat buttons	7.0 (1/4) 3.0 - 7.0 (1/8 - 1/4)	0.5 (1/32) 0.3 - 1.0 (1/64 - 1/16)
	A	Keyhole buttonhole Buttonholes with vertical bar tack for reinforcement in heavyweight or thick fabrics	7.0 (1/4) 3.0 - 7.0 (1/8 - 1/4)	0.5 (1/32) 0.3 - 1.0 (1/64 - 1/16)
	N/O	4 steps buttonhole 1 Left side of 4 step buttonhole	5.0 (3/16) 1.5 - 7.0 (1/16 - 1/4)	0.4 (1/64) 0.2 - 1.0 (1/64 - 1/16)
	N/O	4 steps buttonhole 2 Bar tack of 4 step buttonhole	5.0 (3/16) 1.5 - 7.0 (1/16 - 1/4)	0.4 (1/64) 0.2 - 1.0 (1/64 - 1/16)
	N/O	4 steps buttonhole 3 Right side of 4 step buttonhole	5.0 (3/16) 1.5 - 7.0 (1/16 - 1/4)	0.4 (1/64) 0.2 - 1.0 (1/64 - 1/16)
	N/O	4 steps buttonhole 4 Bar tack of 4 step buttonhole	5.0 (3/16) 1.5 - 7.0 (1/16 - 1/4)	0.4 (1/64) 0.2 - 1.0 (1/64 - 1/16)
	A	Darning Darning of medium weight fabric	7.0 (1/4) 2.5 - 7.0 (3/32 - 1/4)	2.0 (1/16) 0.4 - 2.5 (1/64 - 3/32)

Stitch	Presser foot	Stitch name/ Applications	Stitch width (mm (inch))	Stitch length (mm (inch))
			Auto. Manual	Auto. Manual
	A	Darning Darning of heavyweight fabric	7.0 (1/4) 2.5 - 7.0 (3/32 - 1/4)	2.0 (1/16) 0.4 - 2.5 (1/64 - 3/32)
	A	Bar tack Reinforcement at opening of pocket, etc.	2.0 (1/16) 1.0 - 3.0 (1/16 - 1/8)	0.4 (1/64) 0.3 - 1.0 (1/64 - 1/16)
	M	Button sewing Attaching buttons	3.5 (1/8) 2.5 - 4.5 (3/32 - 3/16)	—
	N/O	Eyelet For making eyelets, holes on belts, etc.	7.0 (1/4) 7.0 6.0 5.0 (1/4 15/64 3/16)	7.0 (1/4) 7.0 6.0 5.0 (1/4 15/64 3/16)
	N/O	Star eyelet For making star-shaped eyelets on holes.	—	—
	N/O	Diagonally left up (Straight) For attaching appliqué on tubular pieces of fabric and mitering corners	—	—
	N/O	Reverse (Straight) For attaching appliqué on tubular pieces of fabric and mitering corners	—	—
	N/O	Diagonally right up (Straight) For attaching appliqué on tubular pieces of fabric and mitering corners	—	—
	N/O	Sideways to left (Straight) For attaching appliqué on tubular pieces of fabric	—	—
	N/O	Sideways to right (Straight) For attaching appliqué on tubular pieces of fabric	—	—
	N/O	Diagonally left down (Straight) For attaching appliqué on tubular pieces of fabric and mitering corners	—	—
	N/O	Forward (Straight) For attaching appliqué on tubular pieces of fabric and mitering corners	—	—
	N/O	Diagonally right down (Straight) For attaching appliqué on tubular pieces of fabric and mitering corners	—	—
	N/O	Sideways to left (Zigzag) For attaching appliqué on tubular pieces of fabric	—	—
	N/O	Sideways to right (Zigzag) For attaching appliqué on tubular pieces of fabric	—	—

Stitch	Presser foot	Stitch name/ Applications	Stitch width (mm (inch))	Stitch length (mm (inch))
			Auto. Manual	Auto. Manual
	N/O	Forward (Zigzag) For attaching appliqué on tubular pieces of fabric and mitering corners	—	—
	N/O	Reverse (Zigzag) For attaching appliqué on tubular pieces of fabric and mitering corners	—	—
	J/C	Piecing stitch (Middle) Piecework/patchwork	—	2.0 (1/16) 0.2 - 5.0 (1/64 - 3/16)
	J/O	Piecing stitch (Right) Piecework/patchwork 6.5 mm (approx. 1/4 inch) right seam allowance	5.50 (7/32) 0.00 - 7.00 (0 - 1/4)	2.0 (1/16) 0.2 - 5.0 (1/64 - 3/16)
	J/O	Piecing stitch (Left) Piecework/patchwork 6.5 mm (approx. 1/4 inch) left seam allowance	1.50 (1/16) 0.00 - 7.00 (0 - 1/4)	2.0 (1/16) 0.2 - 5.0 (1/64 - 3/16)
	J/O	Hand-look quilting Quilting stitch made to look like hand quilting stitch	3.50 (1/8) 0.00 - 7.00 (0 - 1/4)	2.5 (3/32) 0.4 - 5.0 (1/64 - 3/16)
	J/O	Basting stitch Basting	3.50 (1/8) 0.00 - 7.00 (0 - 1/4)	20 (3/4) 5 - 30 (3/16 - 1-1/4)
	J/O	Stem stitch Reinforced stitching, sewing and decorative applications	1.00 (1/16) 0.00 - 7.00 (0 - 1/4)	2.5 (3/32) 0.4 - 5.0 (1/64 - 3/16)
	J/O	Quilting appliqué zigzag stitch Zigzag stitch for quilting and sewing on appliqué quilt pieces	3.50 (1/8) 0.00 - 7.00 (0 - 1/4)	1.6 (1/16) 0.0 - 5.0 (0 - 3/16)
	J/O	Zigzag stitch (Right) Start from right needle position, zigzag sew at left	3.50 (1/8) 2.50 - 5.00 (3/32 - 3/16)	1.6 (1/16) 0.3 - 5.0 (1/64 - 3/16)
	J/O	Zigzag stitch (Left) Start from left needle position, zigzag sew at right	3.50 (1/8) 2.50 - 5.00 (3/32 - 3/16)	1.6 (1/16) 0.3 - 5.0 (1/64 - 3/16)
	J/O	2 steps elastic zigzag Overcasting (medium weight and stretch fabrics), tape and elastic	5.00 (3/16) 0.00 - 7.00 (0 - 1/4)	1.0 (1/16) 0.2 - 5.0 (1/64 - 3/16)
	J/O	3 steps elastic zigzag Overcasting (medium, heavyweight and stretch fabrics), tape and elastic	5.00 (3/16) 0.00 - 7.00 (0 - 1/4)	1.0 (1/16) 0.2 - 5.0 (1/64 - 3/16)
	J/O	Quilting appliqué stitch Quilting stitch for invisible appliqué or attaching binding	2.00 (1/16) 0.00 - 7.00 (0 - 1/4)	2.0 (1/16) 0.4 - 5.0 (1/64 - 3/16)
	J/O	Shell tuck edge Shell tuck edge finish on fabrics	4.00 (3/16) 0.00 - 7.00 (0 - 1/4)	2.5 (3/32) 0.2 - 5.0 (1/64 - 3/16)
	J/O	Blanket stitch Appliqués, decorative blanket stitch	3.50 (1/8) 0.00 - 7.00 (0 - 1/4)	2.5 (3/32) 0.4 - 5.0 (1/64 - 3/16)

Stitch	Presser foot	Stitch name/ Applications	Stitch width (mm (inch))	Stitch length (mm (inch))
			Auto. Manual	Auto. Manual
	J/O	Quilting stippling Background quilting	7.00 (1/4) 0.00 - 7.00 (0 - 1/4)	1.6 (1/16) 0.4 - 5.0 (1/64 - 3/16)
	J/O	Overcasting stitch Stretch knit seam	5.00 (3/16) 0.00 - 7.00 (0 - 1/4)	4.0 (3/16) 0.4 - 5.0 (1/64 - 3/16)
	J/O	Tape attaching Attaching tape to seam in stretch fabric	5.50 (7/32) 0.00 - 7.00 (0 - 1/4)	1.4 (1/16) 0.2 - 5.0 (1/64 - 3/16)
	N/O	Serpentine stitch Decorative stitching and attaching elastic	5.00 (3/16) 0.00 - 7.00 (0 - 1/4)	2.0 (1/16) 0.2 - 5.0 (1/64 - 3/16)
	J/O	Feather stitch Fagoting, decorative stitching	5.00 (3/16) 0.00 - 7.00 (0 - 1/4)	2.5 (3/32) 0.4 - 5.0 (1/64 - 3/16)
	J/O	Fagoting cross stitch Fagoting, bridging and decorative stitching	5.00 (3/16) 0.00 - 7.00 (0 - 1/4)	2.5 (3/32) 0.4 - 5.0 (1/64 - 3/16)
	J/O	Couching stitch Decorative stitching, attaching cord and couching	5.00 (3/16) 0.00 - 7.00 (0 - 1/4)	1.2 (1/16) 0.2 - 5.0 (1/64 - 3/16)
	J/O	Patchwork double overlock stitch Patchwork stitches, decorative stitching	5.00 (3/16) 0.00 - 7.00 (0 - 1/4)	2.5 (3/32) 0.4 - 5.0 (1/64 - 3/16)
	J/O	Smocking stitch Smocking, decorative stitching	5.00 (3/16) 0.00 - 7.00 (0 - 1/4)	1.6 (1/16) 0.4 - 5.0 (1/64 - 3/16)
	J/O	Rick-rack stitch Decorative top stitching	4.00 (3/16) 0.00 - 7.00 (0 - 1/4)	2.5 (3/32) 0.4 - 5.0 (1/64 - 3/16)
	N/O	Decorative stitch Decorative stitching and appliqué	6.00 (15/64) 0.00 - 7.00 (0 - 1/4)	1.0 (1/16) 0.2 - 5.0 (1/64 - 3/16)
	J/O	Decorative stitch Decorative stitching	5.50 (7/32) 0.00 - 7.00 (0 - 1/4)	1.6 (1/16) 0.4 - 5.0 (1/64 - 3/16)
	N/O	Hemstitching Heirloom, decorative hems	5.00 (3/16) 0.00 - 7.00 (0 - 1/4)	2.0 (1/16) 0.4 - 5.0 (1/64 - 3/16)
	N/O	Hemstitching Decorative hems and bridging stitch	6.00 (15/64) 0.00 - 7.00 (0 - 1/4)	2.0 (1/16) 0.4 - 5.0 (1/64 - 3/16)
	J/O	Single diamond overcast Reinforcement and seaming stretch fabric	6.00 (15/64) 0.00 - 7.00 (0 - 1/4)	3.0 (1/8) 0.4 - 5.0 (1/64 - 3/16)
	J/O	Overcasting stitch Reinforcement of stretch fabric or decorative stitching	4.00 (3/16) 0.00 - 7.00 (0 - 1/4)	4.0 (3/16) 0.4 - 5.0 (1/64 - 3/16)
	X	Free motion couching stitch Free motion couching stitch	3.50 (1/8) 2.75 - 3.75 (3/32 - 1/8)	-

INDEX

A

Accessories	
included accessories	15
options	18
Accessory compartment	14
Adjustments	
screen	177
Air vent	12
Alarm sounds	190
Alphabet characters	
embroidery	110
Appliqué	
quilting	79
using an embroidery frame pattern	151
Arrow keys	101
Automatic fabric sensor system	67
Automatic thread cutting key	64
Automatic threading button	13, 42

B

Ball point needle	49
Bar tacks	92
Blind hem stitches	83
Block move key	102
Bobbin	
pulling up the bobbin thread	41
setting	40
winding	36
Bobbin case	
cleaning	176
Bobbin clip	14
Bobbin cover	12
Bobbin threading	
pulling up the bobbin thread	41
setting the bobbin	40
winding the bobbin	36
Bobbin winder	12
Bobbin winding switch	38
Border key	117, 119
Button sewing	93
4 hole buttons	93
shank	93
Buttonhole lever	12
Buttonholes	
four-step	90
odd-shaped/buttons that do not fit the button holder plate	90
one-step	88

C

Character/Decorative Stitches	
adjustments	97
retrieving	99
saving	99
Cleaning	
race	176
Clock	22
Color shuffling function	123
Cord guide bobbin cover	76

D

Darning	91
Dart seam	73
Denim	49
Dual feed foot	51

E

Echo quilting	82
Eco mode	29
Editing	
embroidery edit	114
Embroidery	
adjusting the speed	147
automatic thread cutting function (End color trim)	146
key functions	126
resuming embroidery after turning off the power	138
selecting patterns	108
thread color display	147
thread trimming function (Jump stitch trim)	146
Embroidery appliqué	136
Embroidery edit	
changing the thread color	122
key functions	114
repeated patterns	117
Embroidery foot "W+" with LED pointer	106
Embroidery frames	
attaching	130
inserting fabric	128
removing	130
types	128
using the embroidery sheet	129
Embroidery needle plate cover	135
Embroidery patterns	
checking the position	133
editing	114
embroidering	134
linked characters	148
retrieving	150
saving	150
selecting	108
using a frame pattern to make an appliqué	151
Embroidery sheet	129
Embroidery unit	107
Error messages	187
Eyelet	94

F

Fabric	49
Fabrics	
sewing heavyweight fabrics	69
sewing lightweight fabrics	70
sewing stretch fabrics	70, 89
Fagoting	86
Favorite color scheme	124
Feed dogs	12, 80
Flat bed attachment	12, 107
Flat fell Seam	74
Foot controller	12, 58
Free motion quilting	
free motion echo quilting foot "E"	82
free motion open toe quilting foot "O"	81
free motion quilting foot "C"	80
Free motion sewing mode	80

G

Gathering	74
Grid direction key	101
Guideline marker	64

H

Handle	12
Handwheel	12

Heirloom	87
Hemstitching	
daisy stitch	87
Home page screen	23

I

Image key	116
Insert key	102

K

Key functions	
embroidery	126
embroidery edit	114
MY CUSTOM STITCH	101
utility stitches	25
Knee lifter	12, 66

L

L/R Shift	62
LCD screen	12, 23
light	28
Leather	70

M

Machine help key	31
Main power switch	12
Metallic thread	37
MPEG-4 (MP4) videos	32
Multi-directional sewing	94
MY CUSTOM STITCH	100
retrieving	103
My Design Center	156

N

Needle	49
changing the needle	48
changing the needle position	72
mode	24
twin needle	45
Needle bar thread guide	12, 45
Needle mode selection key	45
Needle plate	12
Needle position	67, 72
Needle position button	13

O

Operation buttons	12, 13
Overcasting	76

P

Piecing	77
1/4 quilting foot with guide	78
Pintuck	75
Pivoting	65
Power cord	22
Power cord receptacle	12
Presser foot	
pressure	67
removing	50
types	194
Presser foot code	125
Presser foot holder	12, 50
Presser foot holder screw	12
Presser foot lever	12, 69
Presser foot lifter button	13
Presser foot/Needle exchange key	45, 48, 50
Pretension disk	12, 37, 39

Q

Quilting	77
free motion	80
with satin stitches	79

R

Race	176
Reinforcement stitch	59
Reinforcement stitch button	13
Repeated patterns	117
Retrieving	
character/decorative stitch patterns	99
embroidery patterns	150
machine's memory	99, 150
MY CUSTOM STITCH designs	103
stitch settings	63
utility stitches	63
Reverse stitch button	13
Reverse/Reinforcement stitches	59

S

Satin stitches	79
Saving	
character/decorative stitches	99
embroidery patterns	150
machine's memory	99, 150
stitch settings	63
utility stitches	63
Scallop stitches	85
Screen saver	30
Set key	101
Settings	
automatic thread cutting	64, 146
embroidery settings	29
general settings	28
machine settings key	27
sewing settings	27
stitch length	62
stitch width	62
thread tension	62, 143
thread trimming	146
Sewing speed controller (speed control slide)	12, 13, 56
Sewing type selection key	31
Shelltuck stitches	85
Shutoff support mode	29
Single/Triple stitching key	102
Smocking stitches	85
Speaker	28
Specifications	192
Spool cap	12
Spool net	37
Spool pin	12
Spool stand	39, 46
Stabilizer	127
Start/Stop button	13
Starting point key	148
Step stitch patterns	98
Stitch setting chart	194
Straight stitch foot	67
Straight stitch needle plate	67
Straight stitches	72
Supplemental spool pin	12, 36, 45
Tape or elastic attaching	86
Terms of Use	6
Thread	49
thread tension	62, 143
Thread color display	147
Thread color palette	122
Thread cutter	12, 58

T

Thread cutter button	13
Thread guide	12, 37, 39, 45
Thread guide plate	12, 39, 42
Thread marks	119
Touch pen	23, 178
Transparent nylon thread	37, 38, 49
Trial key	133
Troubleshooting	178
Tutorial video	31
Twin needle	45

U

Upgrading	194
Upper thread	49
Upper threading	
twin needle mode	45
using the Automatic threading button	42
USB mouse	35
USB port	12
Utility stitches	
key functions	25
pattern explanation key	32
retrieving	63
saving	63
sewing type selection key	31
stitch setting chart	194

V

Vinyl fabrics	70
---------------------	----

W

Walking foot	50
--------------------	----

Z

Zigzag stitches	76
Zipper insertion	
centered	95
side	95













Please visit us at <http://s.brother/cpeaa/> where you can get product support and answers to frequently asked questions (FAQs).



Be sure to install the latest software.
A variety of functional improvements are being performed in the latest version.



Brother SupportCenter is a mobile app that provides the support information for your Brother product.

This machine is approved for use in the country of purchase only. Local Brother companies or their dealers will only support machines purchased in their own countries.