

ENGLISH

**LBH-1796AN
INSTRUCTION MANUAL**

CONTENTS

I. IMPORTANT SAFETY INSTRUCTIONS	1
II. SPECIFICATIONS.....	1
1. Specifications.....	2
2. Standard sewing shape list.....	3
3. Configuration	4
III. INSTALLATION.....	5
IV. PREPARATION BEFORE OPERATION.....	21
1. Lubrication	21
2. Inserting the needle.....	22
3. Threading the needle-thread.....	23
4. Threading the bobbin case	23
5. Adjusting the bobbin thread tension	24
6. Installation of bobbin case.....	24
7. Installing the knife	25
8. Item to be checked before turning the power ON.....	25
V. OPERATION OF THE SEWING MACHINE.....	26
1. Explanation of the operation panel switch.....	26
2. Basic operation of the sewing machine	28
3. How to use the pedal.....	30
4. Performing pattern selection.....	33
5. Changing needle thread tension	34
6. Performing re-sewing.....	35
7. Winding bobbin thread.....	36
8. Using the counter	37
9. Using the initial value pattern.....	39
10. Changing sewing data.....	40
11. Method of setting sewing data with/without edit	42
12. Sewing data list.....	43
13. Copying sewing pattern	49
14. How to edit/check the data other than sewing data	50
15. Using parameter register key	52
16. Performing continuous stitching	53
17. Performing cycle stitching.....	57
18. How to change the name of cycle/continuous sewing data	59
19. Explanation of the service patterns	60
20. Explanation of plural motions of knife.....	62
21. Method of changing memory switch data	63
22. Memory switch data list	64
23. How to change the sewing speed while the sewing machine is engaged in sewing	68

24. How to adjust the pedal variable resistor.....	69
25. How to adjust the contrast.....	70
26. How to set the key lock	70
27. Communication.....	71
28. Setting the irregular work	75
VI. MAINTENANCE.....	77
1. Adjusting the needle-to-hook relation	77
2. Adjusting the needle thread trimmer	78
3. Adjusting the presser bar pressure	79
4. Adjustment of the bobbin presser unit.....	79
5. Thread tension	80
6. Replacing the fuse.....	81
7. Adjusting the parallel lifting of the presser foot.....	81
8. Accessory adhesive tape	82
9. Auxiliary sheet	83
10. Material-feed auxiliary sheet (optional)	83
VII. GAUGE COMPONENTS	85
1. Cloth cutting knife	85
VIII. ERROR CODE LIST	86
1. How to operate the sewing machine in the case an error is displayed.....	86
2. Operation procedure to be followed when a message is displayed.....	91
IX. TROUBLES AND CORRECTIVE MEASURES.....	92
X. DRAWING OF THE TABLE.....	94
XI. INITIAL VALUE DATA FOR EACH SHAPE TABLE	95

I. IMPORTANT SAFETY INSTRUCTIONS

- 1) Never operate the machine unless the oiling tank has been properly lubricated.
- 2) After the completion of a day's work, remove dust and dirt accumulating on the hook, bobbin thread trimming knife section and lubricating hole of the oil tank. At this time, also check whether or not the oil quantity is adequate.
- 3) Be sure to return the starting pedal to the home position after the machine has started to run.
- 4) This machine is provided with a machine head tilt detector so that it cannot be operated in the state that the machine head is tilted. When operating this sewing machine, turn the power switch ON after setting the sewing machine to the bed base properly.

II. SPECIFICATIONS

Main specifications of the LBH-1796AN computer-controlled, lockstitch buttonholing machine.

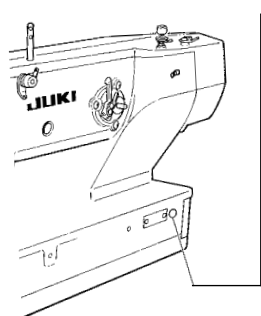

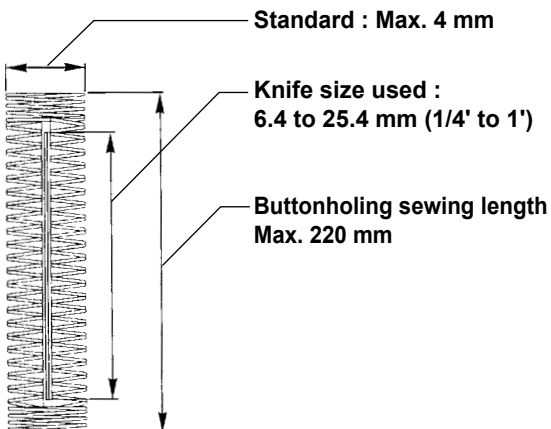
Subclass	Ⓢ
Major application	Buttonholing of cloth such as men's shirts, blouses, work uniforms, ladies' wear, etc.
Buttonholing size	 <p>Standard : Max. 4 mm</p> <p>Knife size used : 6.4 to 25.4 mm (1/4' to 1')</p> <p>Buttonholing sewing length Max. 220 mm</p>

1. Specifications

Sewing speed	Standard speed : 3,600 sti/min (Max. : 4,200 sti/min) (Max. : 3,300 sti/min when dry hook is used)
Needle	DP×5 #11J to #14J
Hook	DP type full-rotary hook
Needle rocking drive method	Drive by stepping motor
Feed drive method	Drive by stepping motor
Presser lifting drive method	Drive by stepping motor
Lift of presser foot	14 mm (Optional setting available) Max. : 6 mm (In the case of parallel lifting of the presser foot) *1
Cloth cutting knife drive method	Motor-driven crank system
Standard sewing shape	31 kinds
Number of patterns stored in memory	99 patterns
Mass	Machine head 55 kg, Control box 5.5 kg
Power consumption	370 VA
Operating temperature range	5 °C to 35 °C
Operating humidity range	35% to 85% (No dew condensation)
Line voltage	Rated voltage ± 10 % 50/60 Hz
Noise	- Equivalent continuous emission sound pressure level (L _{pA}) at the workstation : A-weighted value of 81.0 dB ; (Includes ; K _{pA} = 2.5 dB) ; according to ISO 10821- C.6.3 -ISO 11204 GR2 at 3,600 sti/min.

*1: In the case of parallel lifting of the work clamp foot, the amount of lift is limited to 4.8 mm at the maximum when the position of the work clamp foot is in the range of 182.1 to 220.0 mm.

2. Standard sewing shape list

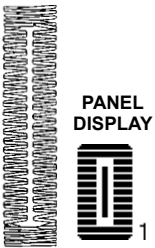
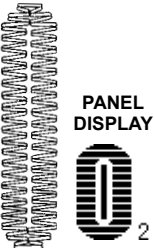
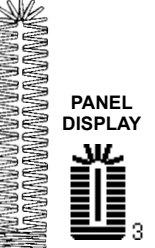
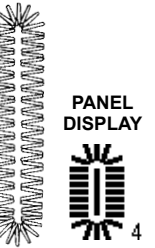
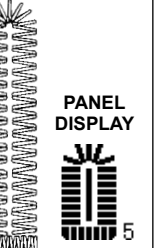
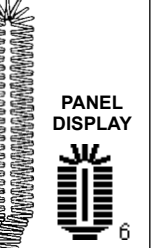
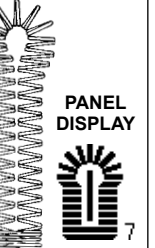
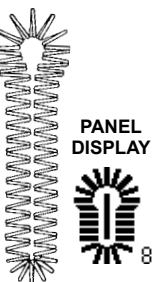
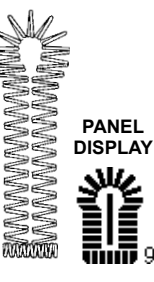
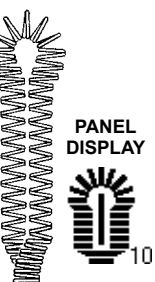
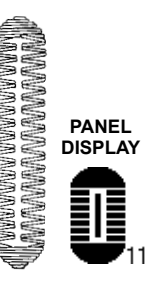
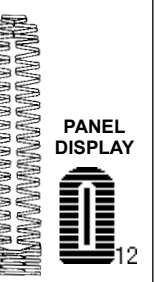
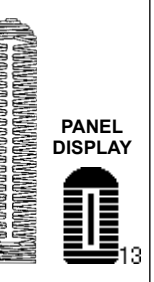
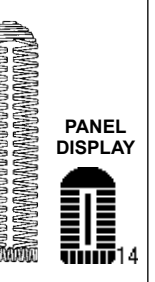
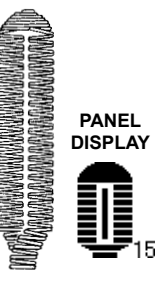
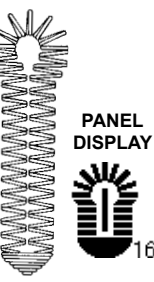
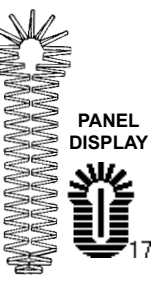
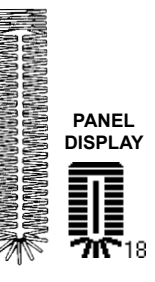
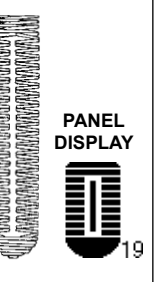
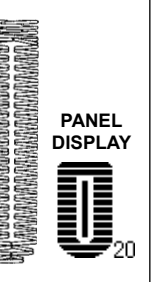
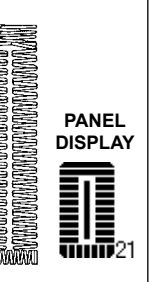
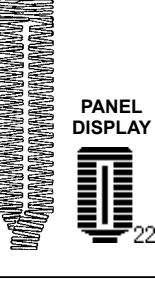
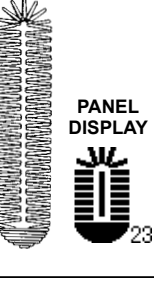
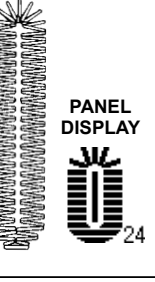
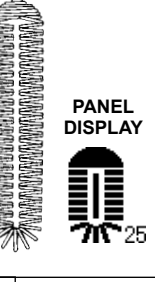
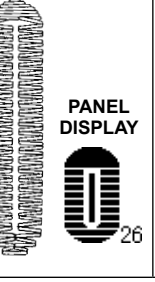
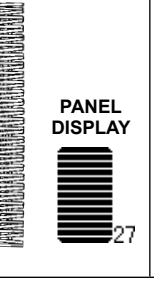
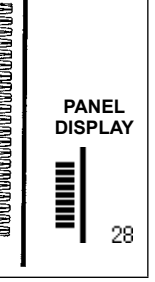
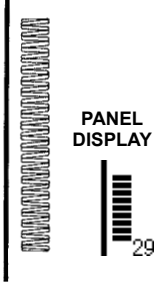
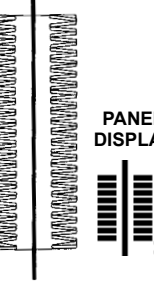
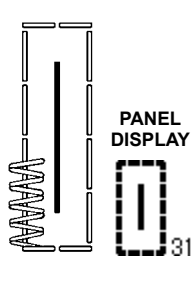
(1) Square type	(2) Round type	(3) Radial square type	(4) Radial type	(5) Radial straight bar-tacking type	(6) Radial taper bar-tacking type	(7) Eyelet square type
 PANEL DISPLAY 1	 PANEL DISPLAY 2	 PANEL DISPLAY 3	 PANEL DISPLAY 4	 PANEL DISPLAY 5	 PANEL DISPLAY 6	 PANEL DISPLAY 7
(8) Eyelet radial type	(9) Eyelet straight bar-tacking type	(10) Eyelet taper bar-tacking type	(11) Semilunar type	(12) Round square type	(13) Semilunar square type	(14) Semilunar straight bar-tacking type
 PANEL DISPLAY 8	 PANEL DISPLAY 9	 PANEL DISPLAY 10	 PANEL DISPLAY 11	 PANEL DISPLAY 12	 PANEL DISPLAY 13	 PANEL DISPLAY 14
(15) Semilunar taper bar-tacking type	(16) Eyelet semi-lunar type	(17) Eyelet round type	(18) Square radial type	(19) Square semilunar type	(20) Square round type	(21) Square straight bar-tacking type
 PANEL DISPLAY 15	 PANEL DISPLAY 16	 PANEL DISPLAY 17	 PANEL DISPLAY 18	 PANEL DISPLAY 19	 PANEL DISPLAY 20	 PANEL DISPLAY 21
(22) Square taper bar-tacking type	(23) Radial semi-lunar type	(24) Radial round type	(25) Semilunar radial type	(26) Semilunar round type	(27) Bar-tacking	(28) Bar-tacking, right cut
 PANEL DISPLAY 22	 PANEL DISPLAY 23	 PANEL DISPLAY 24	 PANEL DISPLAY 25	 PANEL DISPLAY 26	 PANEL DISPLAY 27	 PANEL DISPLAY 28
(29) Bar-tacking, left cut	(30) Bar-tacking, center cut	(31) Basting + Cloth cutting knife				
 PANEL DISPLAY 29	 PANEL DISPLAY 30	 PANEL DISPLAY 31				

3. Configuration

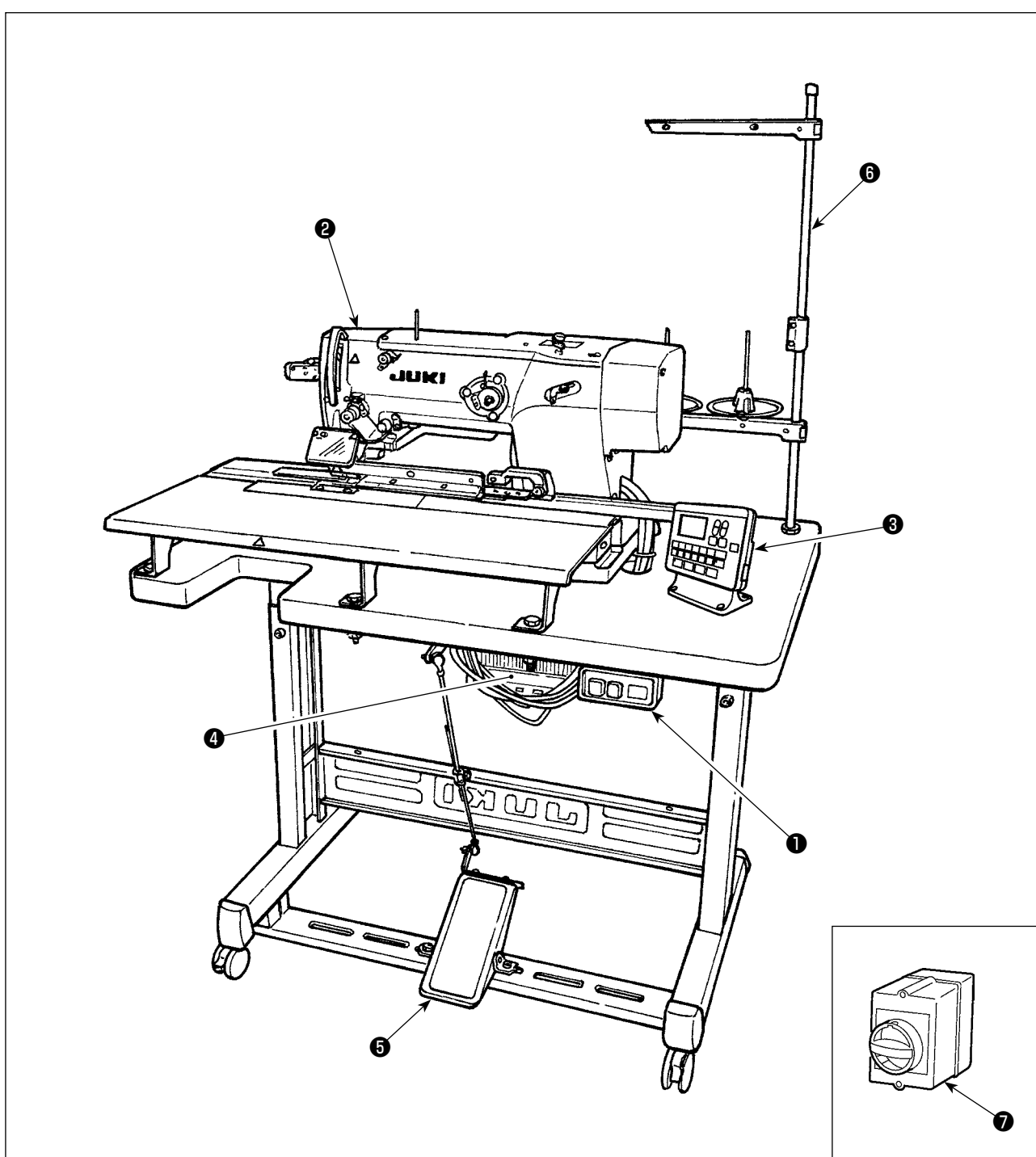

LBH-1796AN consists of the following components.

①	Power switch
②	Machine head (LBH-1796AN)
③	Operation panel
④	Control box (MC-602)
⑤	Presser lifting and starting pedal
⑥	Thread stand device
⑦	Power switch (EU type)

III. INSTALLATION



WARNING :

To prevent possible accidents caused by the fall of the sewing machine, perform the work by two persons or more when the machine is moved.

(1) Preparation for assembly of the control box

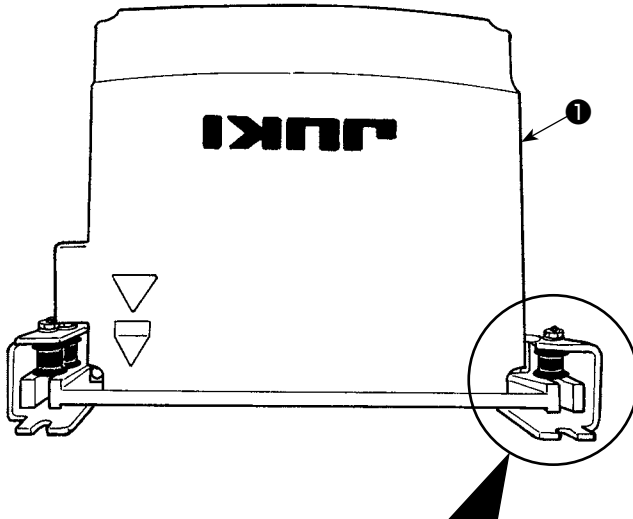

1) Fix toothed washers (2) and rubber cushions (3) on control box (1). (At four locations)

* Tighten the toothed washers so that their height becomes 0.8 mm.

2) Fix control box mounting plate (4) with plain washers (5) and nuts (7). (At four locations)

* Fix the mounting plate while fitting the screw in the U-groove in the mounting plate.

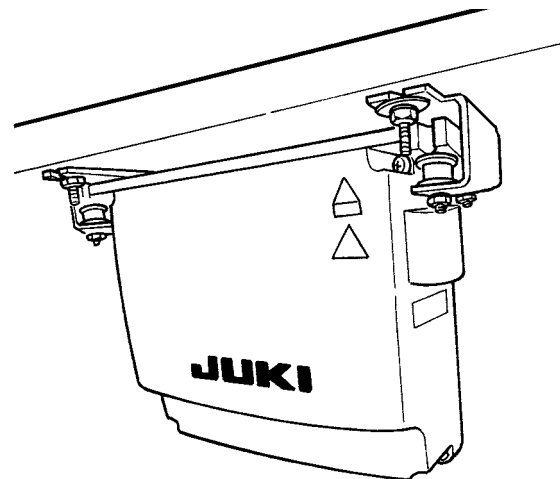
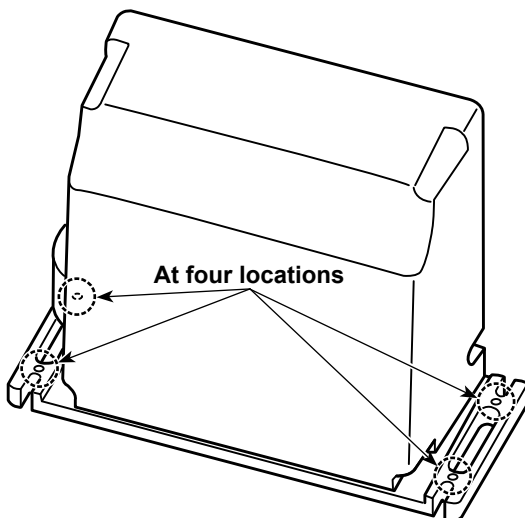
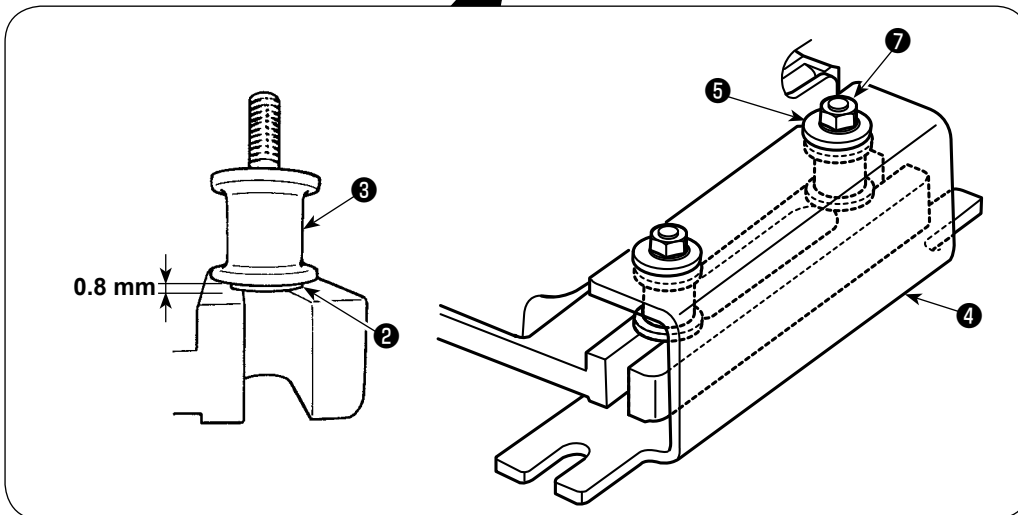

(2) Set-up of the table

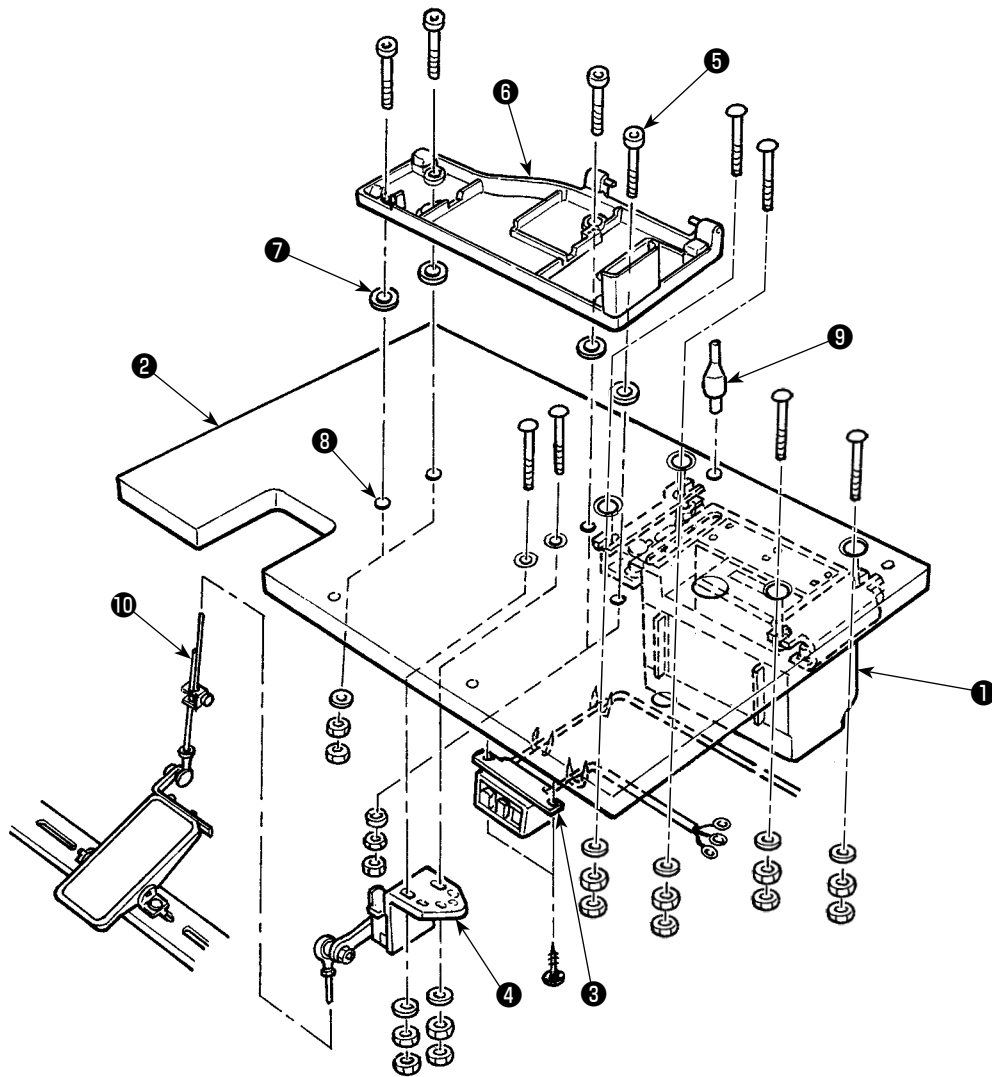

- 1) Fix control box ① , power switch ③ and pedal sensor ④ on table ② .
- 2) Fix power switch ③ with a staple.
- 3) Pass four bed base fixed screws ⑤ through bed base ⑥ .
- 4) Set rubber cushions ⑦ to holes ⑧ (4 places) for fixing bed base and fix bed base ⑥ .
- 5) Fix head support bar ⑨ on table ② .
- 6) Place the main unit of the sewing machine on bed base ⑥ . Then, connect the pedal and pedal sensor ④ with connecting rod ⑩ supplied with the unit.

(3) Connecting the power source cord

- Connecting the power cable

Voltage specifications are shown on the power indication tag attached on the power cable and on the rating plate adhered on the power box. Connect the cable which matches the specifications.

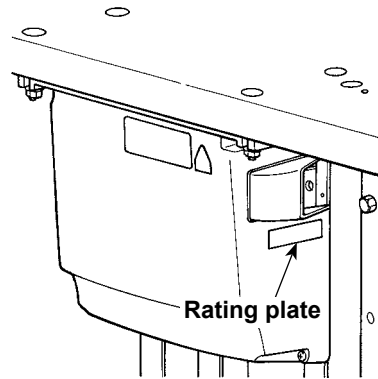
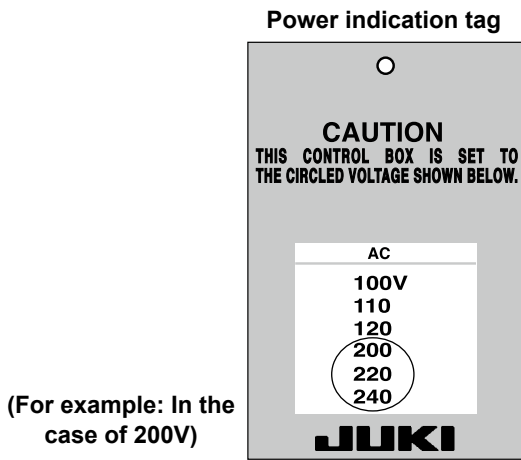

Never use under the wrong voltage and phase.

- Connecting single phase 220V, 230V and 240V

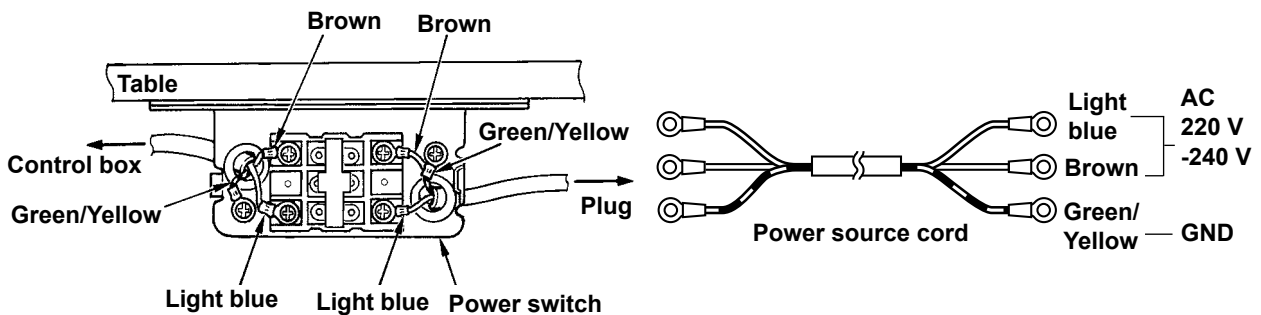

- Connecting three phase 200V, 220V, 230V and 240V

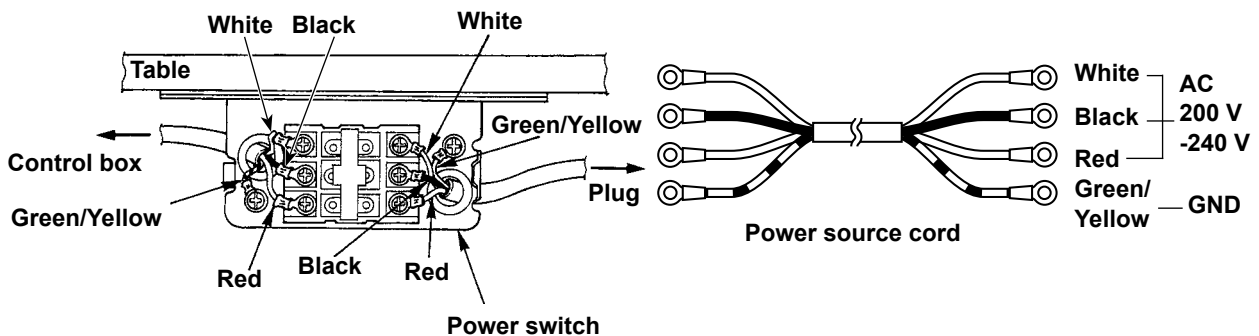

(4) Installing the sewing machine main unit

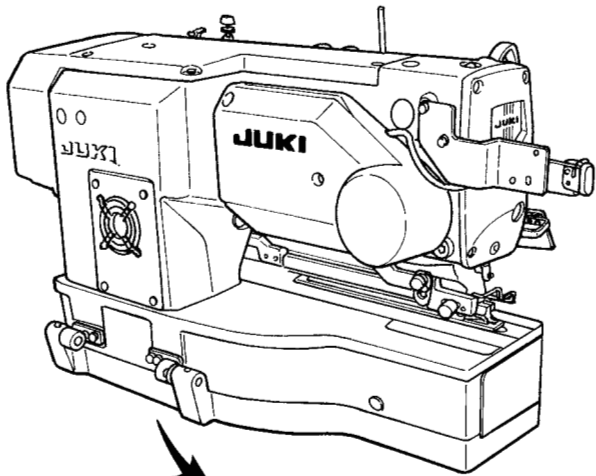

WARNING :

To prevent possible accidents caused by the fall of the sewing machine, perform the work by two persons or more when the machine is moved.

Place hinge plates **1** and shaft bearings **2** -1 (rubber) and **2** -2 (metal) in two places on the head base and fix the hinge plates to the machine head with setscrews **3** in two places.

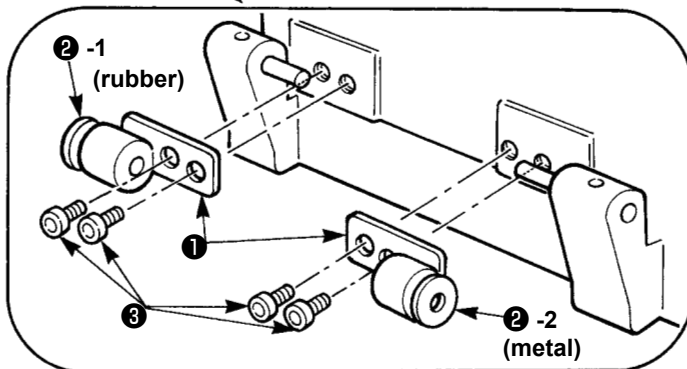

When the rubber hinge and metal fitting hinge are installed in reverse order, it is dangerous since the sewing machine shakes when it is tilted. So, be careful.

(5) Preparation for installation of the feed plate, sub tables and positioning gauge

The parts listed below should be prepared in order to install the feed plate, sub tables and positioning gauge on the machine head.

Feed plate

- Two setscrews

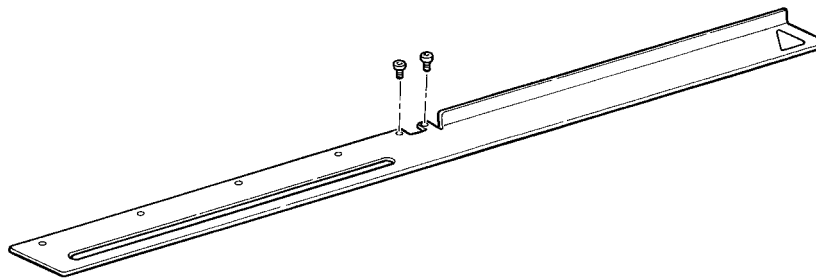

Sub table B

- Two setscrews

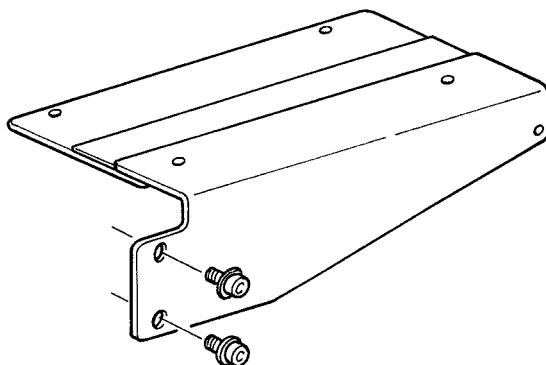

Sub table A

(To be used for fastening the sub table A to the machine head)

- Two setscrews

(To be used for fastening the sub table A to the sub table B)

- Two setscrews

(To be used for fastening the sub table A to the table)

- Two setscrews

- Four washers

- Two pieces of rubber

- Four nuts

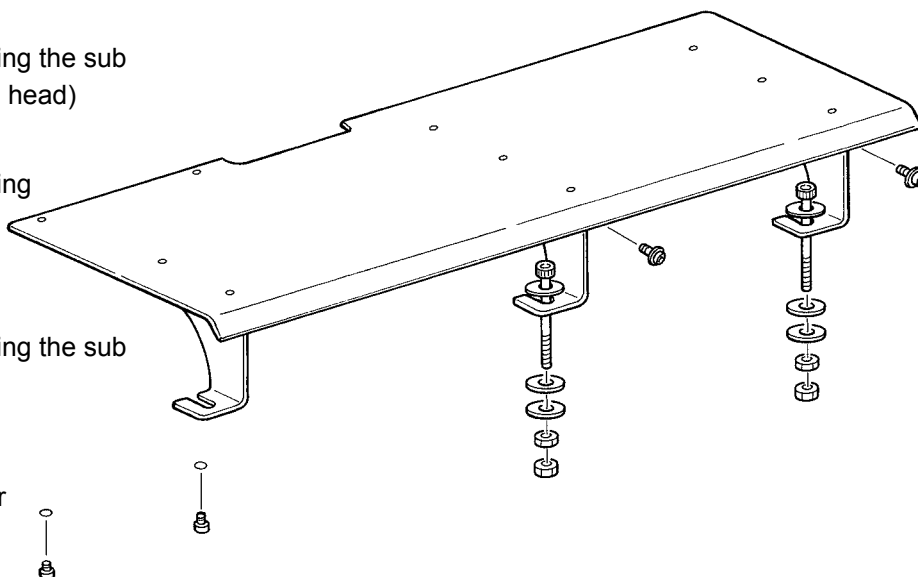

Positioning gauge

- Four setscrews

- Four washers

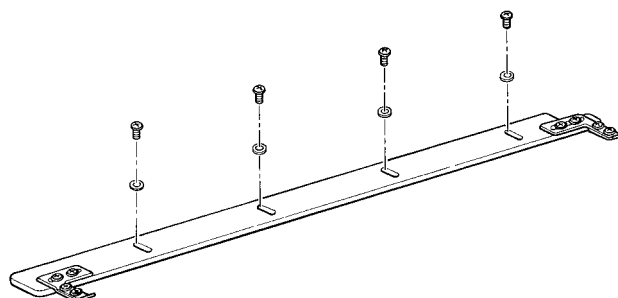

(6) Installing the feed plate

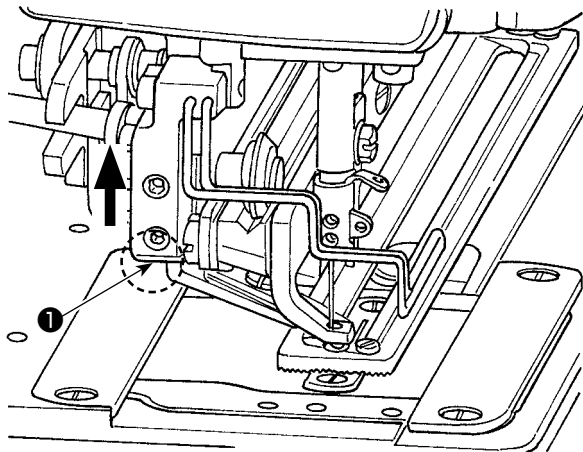

- 1) Holding section ①, lift up the presser foot and place feed plate ②, which is supplied with the unit, in position.



Wipe the grease (for rust prevention) off the top surface of the bed. Then, attach the feed plate.

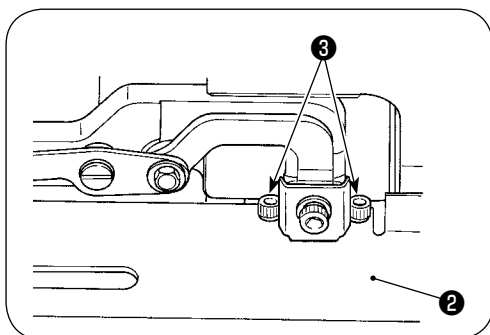

- 2) Temporarily put two accessory setscrews ③ into the corresponding tapped holes.
- 3) Adjust so that an equal lateral clearances (0.1 mm) is provided respectively between right and left throat plate bases ④ and feed plate ②.
- 4) Tighten setscrews ③.

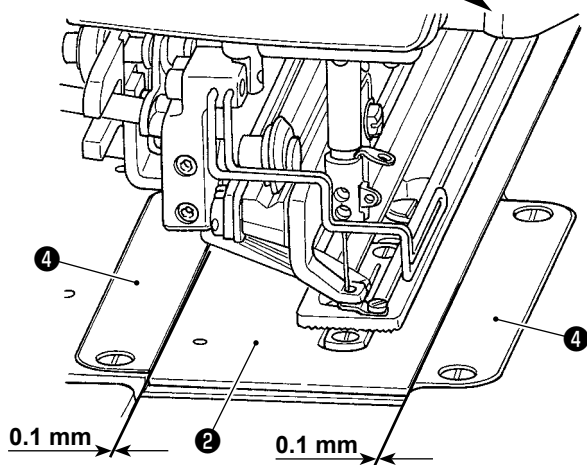

- 5) Lower the presser foot. Then, move feed plate ② back and forth to confirm that the feed plate can be moved smoothly. (with a force of 30 N or less).

If feed plate ② comes in contact with throat plate base cover ④ when moving the former back and forth, loosen setscrews ③ and re-position feed plate ② appropriately.

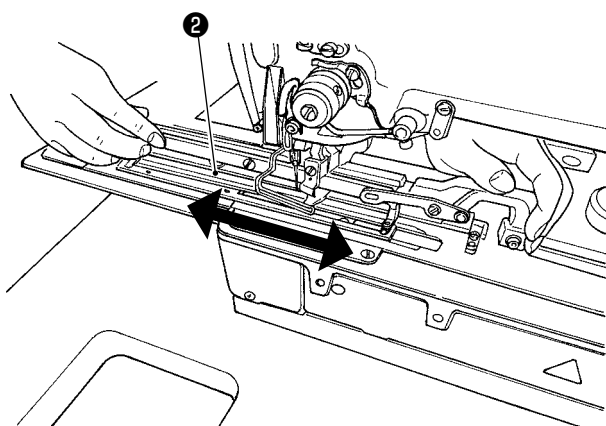

1. Be careful not to place your hand under the presser foot when lowering it.
2. Be aware that the feed mechanism can lose synchronism if the feed plate cannot be moved smoothly due to a hitch or an irregular torque.
3. If the feed plate is moved forward again when the scissors has projected to reach to thread trimming position, the feed plate can overpass the closing cam to cause the sewing machine to lock.

(7) Installing the sub tables

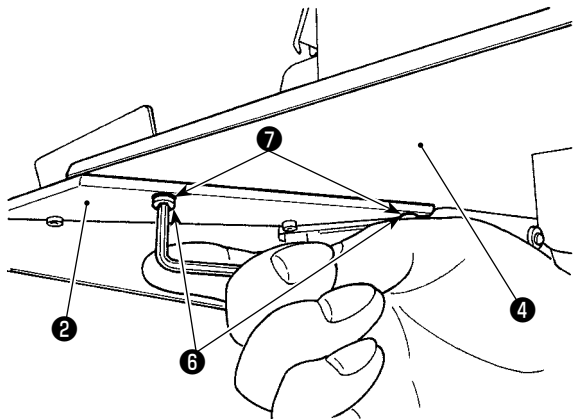
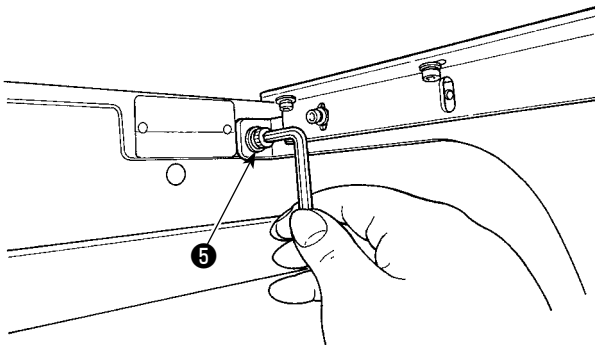
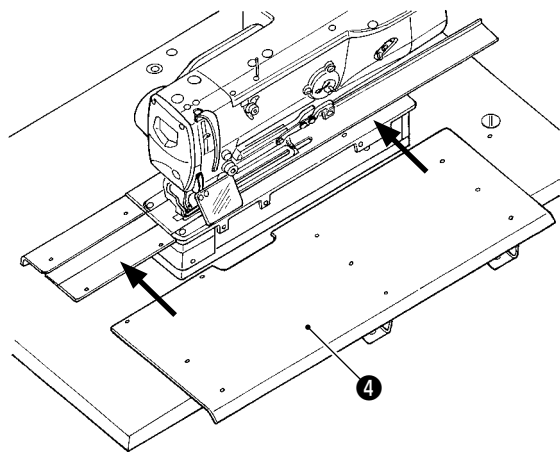
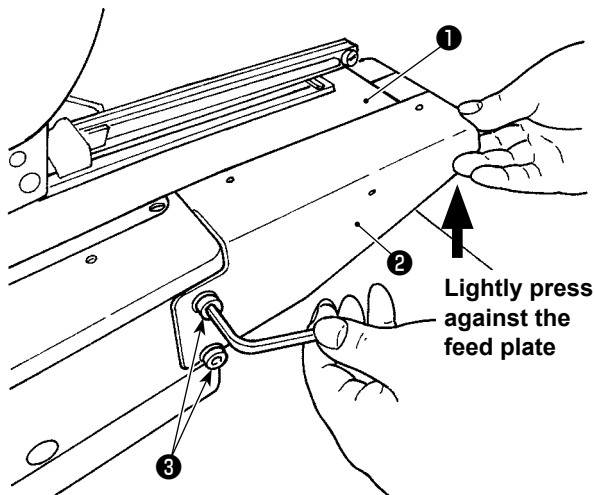

- 1) Move feed plate ① forward. Lightly press sub table B ②, supplied with the unit. Then, temporarily tighten setscrews ③.

If the sub table B does not support the feed plate when the latter moves forward, the presser foot fails to hold the material securely, causing stitch skipping and thread breakage.



On the other hand, if the sub table B is excessively pressed against the feed plate, the feed mechanism can lose synchronism due to an excessive load when it is moved forward.

- 2) Fit sub table A ④, supplied with the unit, to the bed and sub table B ②.

- 3) Temporarily fix sub table A ④, supplied with the unit, on the machine head with two setscrews ⑤.

- 4) Join sub table A ④ to sub table B ② with two setscrews ⑥ and two washers ⑦.

- 5) Firmly tighten all the setscrews which have been temporarily tightened.

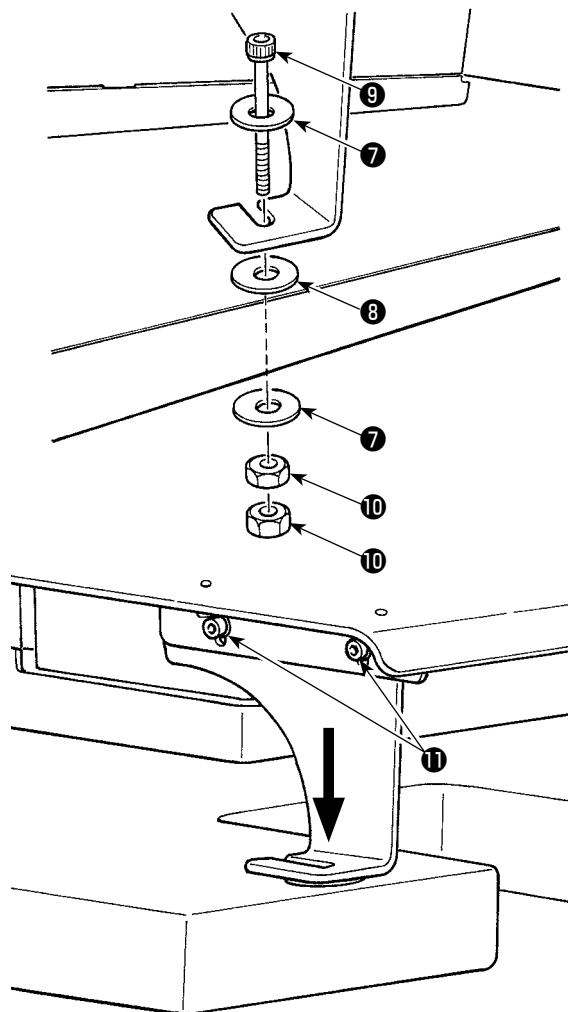

- 6) Move the feed plate back and forth to check that it can be moved smoothly without being hitched along the sub tables.



If the feed plate and the sub tables are joined in the state where they interfere with each other, an extra load can be produced. In this case, the feed mechanism can lose synchronism.

- 7) Mount the base of the sub table A on the table with two setscrew 9 and nut 10 with washer 7 and a piece of rubber 8 placed between them.

- 8) Fix the support metal plate which supports the sub table A with two setscrews 11 while pressing it in the direction of the arrow so that it project the table by 0.1 to 1 mm.



If the sub table A is not closely fitted to the table and not applied with an adequate pressure, the sub table A can vibrate heavily at a sewing speed around 2,000 sti/min to make a noise.

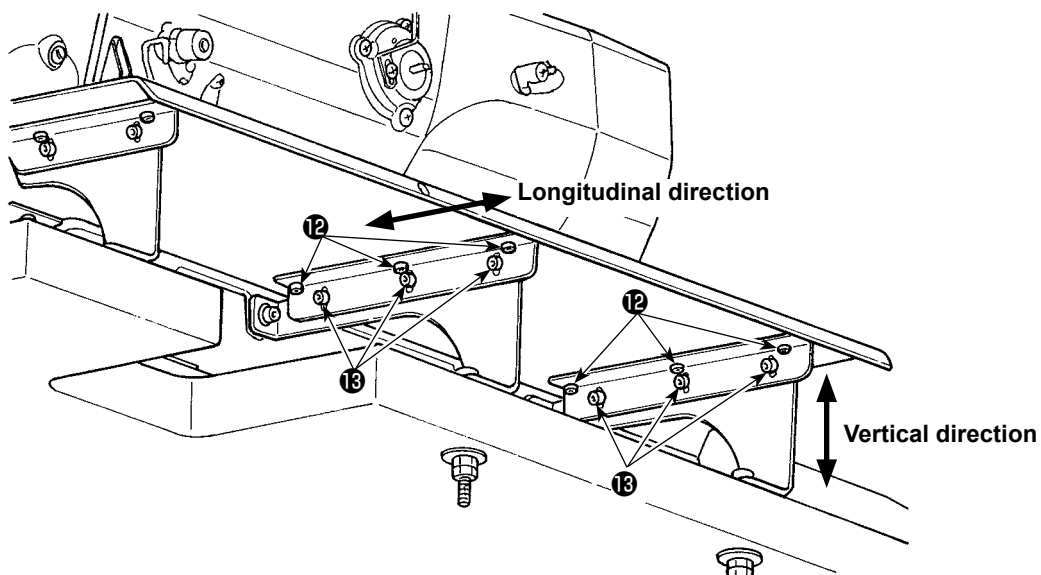

- 9) In the case the longitudinal mounting direction of the sub table A is not correct, loosen six setscrews 12 and re-position the sub table A. Then, fix it in the correct position.
In the case the vertical mounting direction of sub table A is not correct, loosen six setscrews 13 and re-position sub table A. Then, fix it in the correct position.



If the sub table A is fitted excessively near the bed, it can come in contact with the feed plate causing the feed mechanism to lose synchronism.

(8) Temporarily installing the positioning gauge

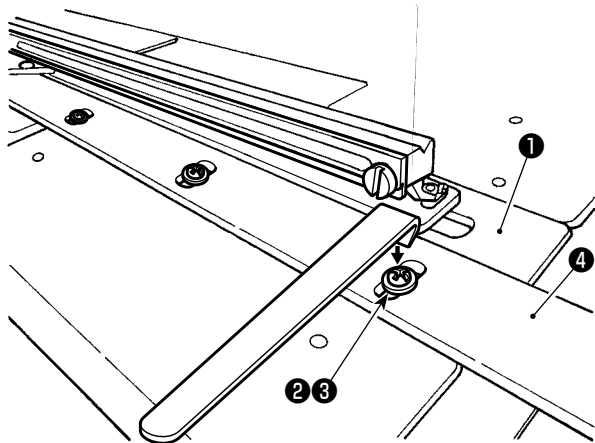

- 1) Move feed plate ❶ forward.
- 2) Temporarily fix positioning gauge ❷ on the feed plate with setscrews ❸ and washers ❹ (four pieces each).

(9) Adjusting the positioning gauge

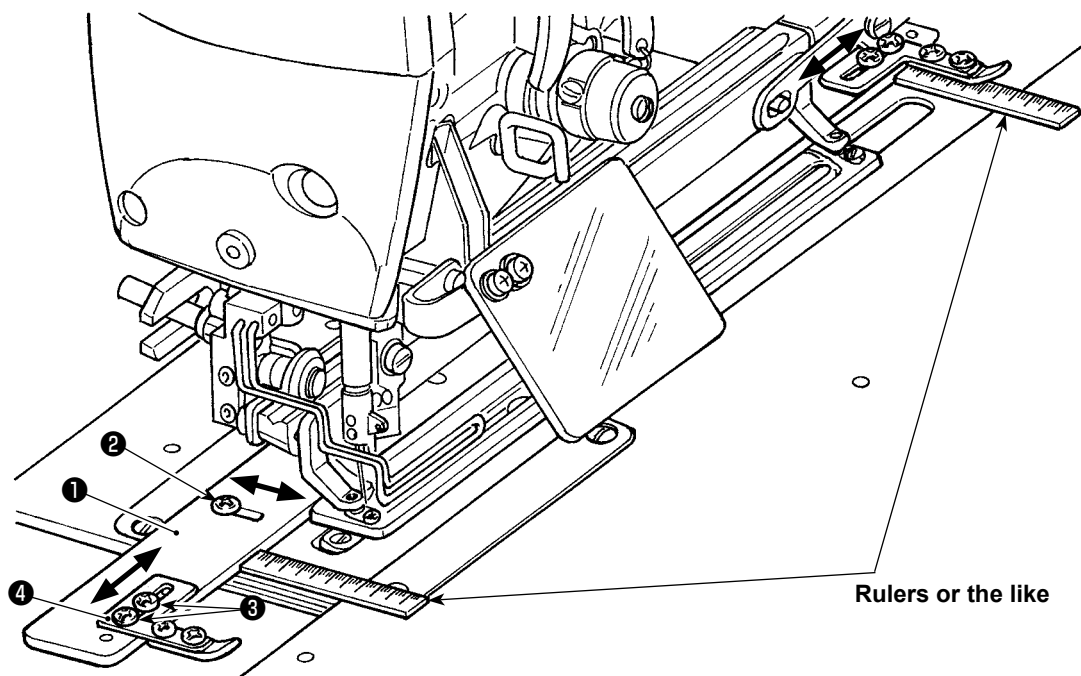

- 1) Loosen setscrews ❸ (at four locations) of positioning gauge ❶ .
- 2) Fit a ruler respectively at the front side and the far side of positioning gauge ❶ to determine its position.
- 3) Once the position of the positioning gauge is determined, tighten three setscrews ❸ .
- 4) Loosen setscrews ❹ of buttonhole interval gauge ❷ .
- 5) Move buttonhole interval gauge ❷ to obtain a desired buttonhole interval.
- 6) Once the position of the buttonhole interval gauge is determined, tighten setscrews ❹ .
(If the positioning gauge is not necessary, it should be removed.)

Adjustable range of the positioning gauge (a distance from the center of the knife slot)
13 mm - 23 mm



1. If setscrew ❸ is tightened with a tightening torque of 2.0 N·m or more, the screw threads can be damaged. Be careful not to tighten the setscrews excessively.
2. In the case the adjustment range of the positioning gauge is adjusted to less than 13 mm, the gauge can tilt.

(10) Tilting the sewing machine head



WARNING :

When tilting/raising the sewing machine head, perform the work so as not to allow your fingers to be caught in the machine. In addition, to avoid possible accidents caused by abrupt start of the machine, turn OFF the power to the machine before starting the work.

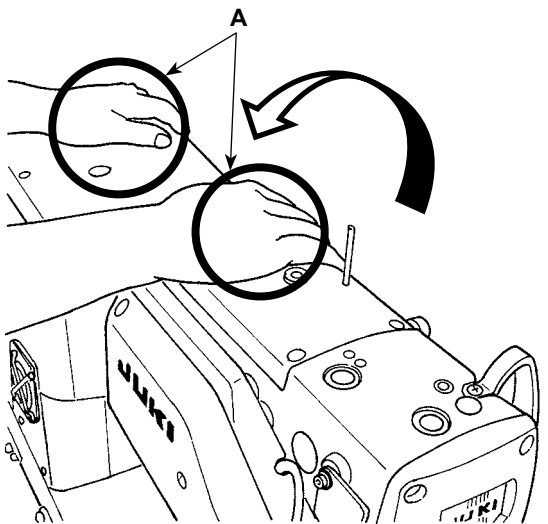
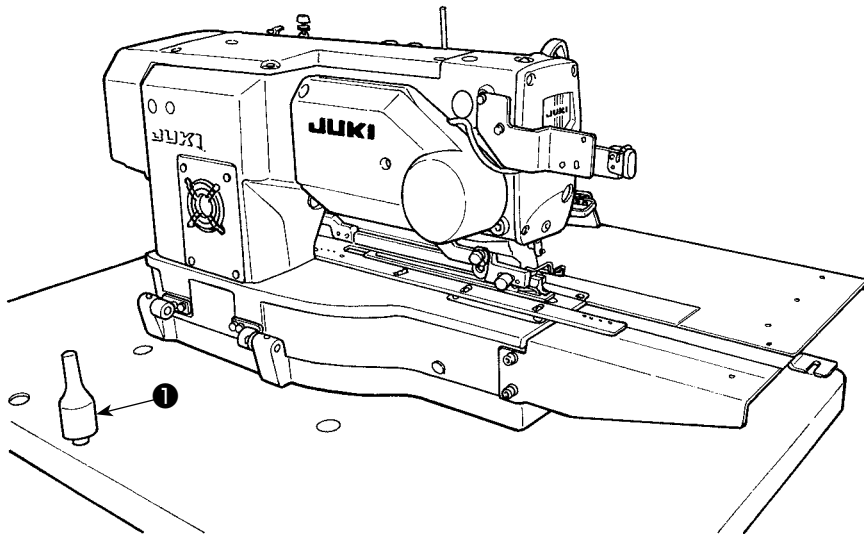

- 1) Turn the thread stand unit to a position where it is not an obstacle to the conduct of the following procedure.
- 2) Whenever you tilt the machine head, go around behind the sewing machine and check to make sure that the top cover and the motor cover are securely fixed. Then, holding **A** sections of the machine head with both hands, carefully tilt the machine head until the machine head comes in contact with machine head supporting rod **1**.

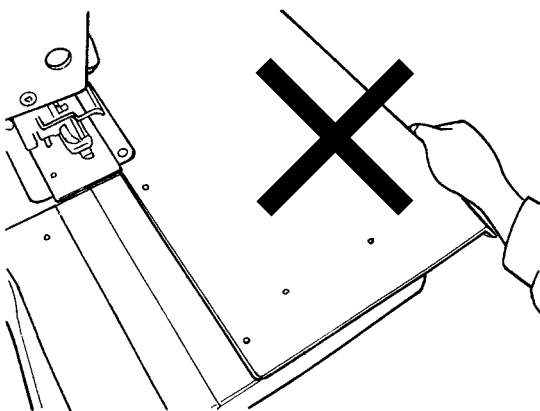

1. Make sure that sewing machine head support bar **1** is placed on the table before tilting the sewing machine.



2. To protect fall-down, be sure to tilt the sewing machine in a level place.

3. Never tilt the machine head while holding it by the sub table.

(11) Connecting the machine head tilt detector

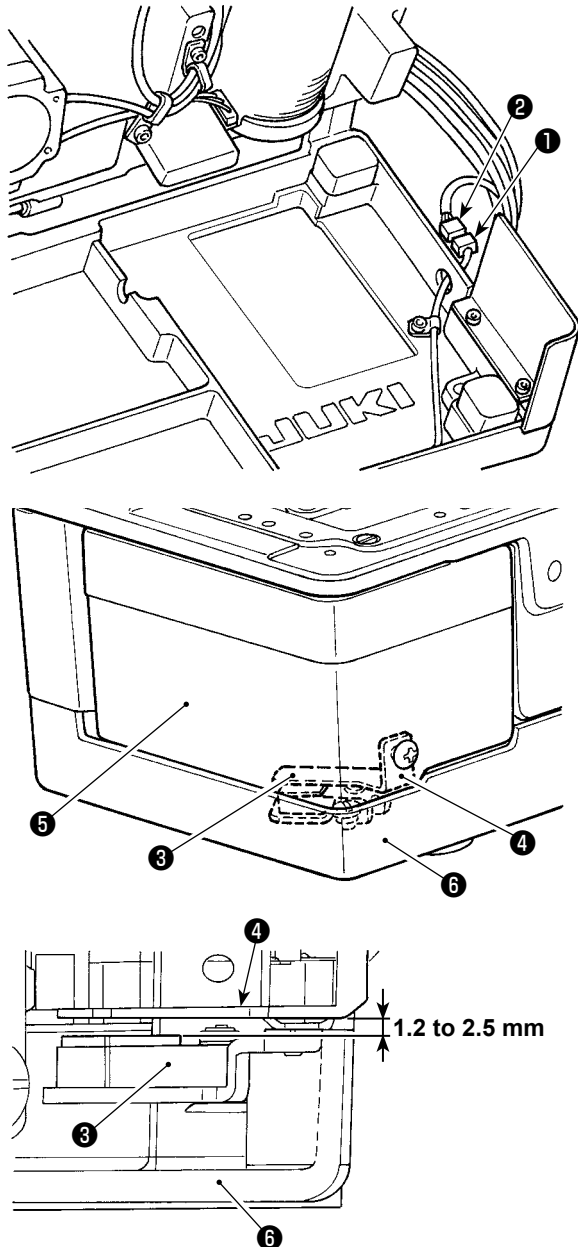

1) Connect machine head tilt detector ① with connector ② located on the machine head side.

2) Adjust detecting plate ④ so that a clearance of 1.2 to 2.5 mm is provided between tilt detection sensor ③ and detecting plate ④.

Press READY key  to confirm that no error occurs.

In addition, open and close hook cover ⑤ to confirm that detecting plate ④ does not interfere with bed base ⑥.

Caution
If detecting plate ④ is not properly adjusted, E302 (machine head tilt error or hook cover open error) can occur to disable the normal operation of the sewing machine.

(12) Installing the hook oil shield plate

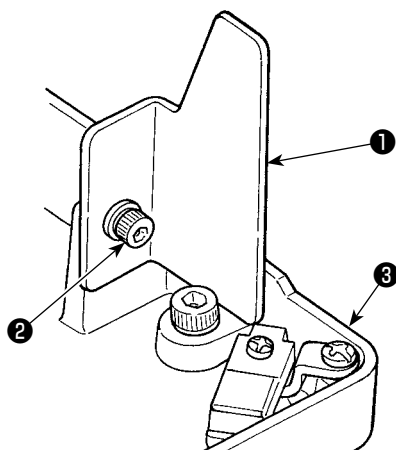

Install hook oil shield plate ① onto bed base ③ with setscrew ②.

Attach hook oil shield plate ① to the bed base with the sewing machine raised.

In addition, check to be sure that the sewing machine does not interfere with hook oil shield plate ① when tilting/raising the former.

Adjust the mounting of the hook oil shield plate ① to prevent scattered from the gap between the bed and cover pot.

(13) Installing the operation panel

(Standard installation)

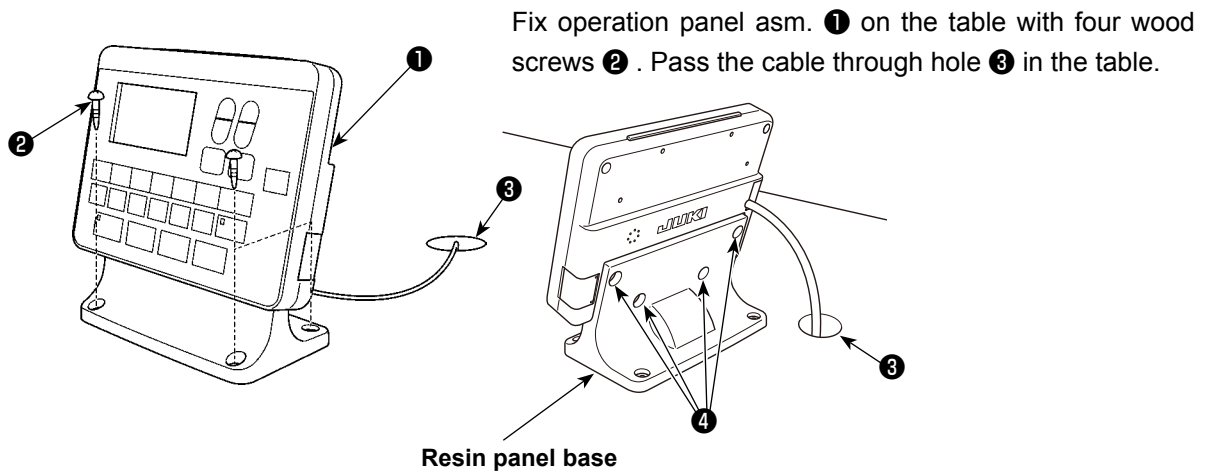

(Installation using the accessory plate)

If the operation panel comes in contact with the sewing material, the accessory plate should be used to prevent the contact.

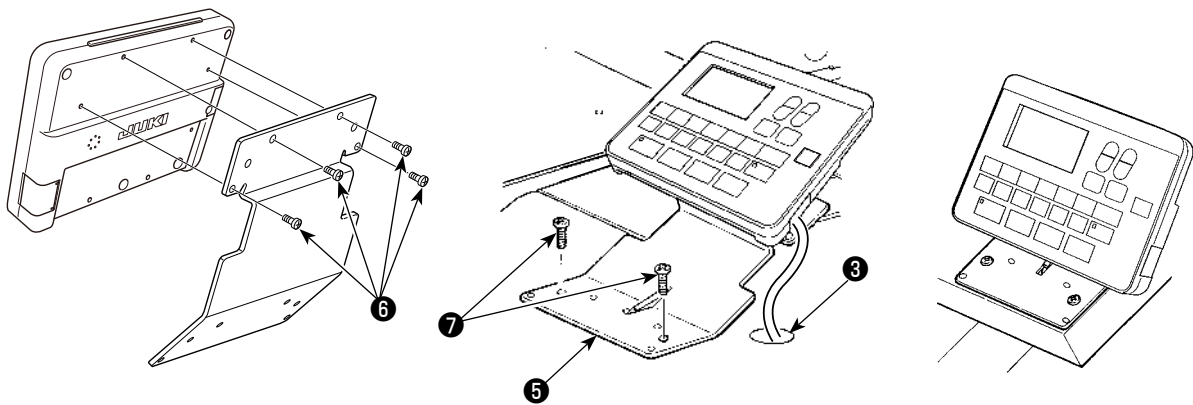

- 1) Remove four tapping screw ④ from the resin panel base to detach the operation panel.
- 2) Install panel mounting plate ⑤ , supplied with the unit, with four accessory setscrews ⑥ instead of the tapping screws.



If panel mounting plate ⑤ is installed with tapping screws ④ which are removed from the resin panel base, the panel PCB can be damaged.

- 3) Fix panel mounting plate ⑤ on the table with two wood screws ⑦ . Pass the cable through hole ③ in the table.

(14) Connecting the cords

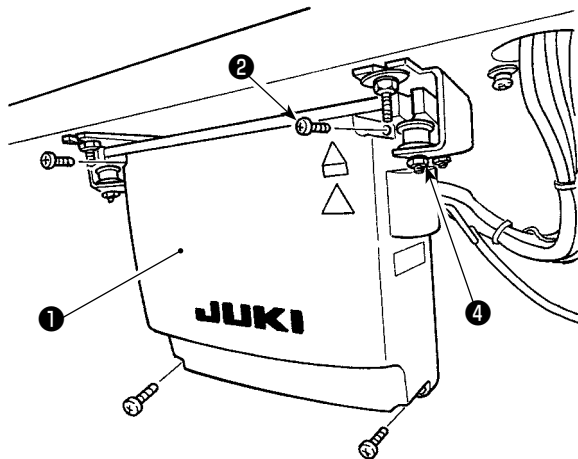

- 1) Loosen four setscrews ② of control box cover ① . Remove control box cover ① .
- 2) Connect the cord to the connector on the MAIN PCB as illustrated in the figure below.
- 3) Fix the earth cord with setscrew ③ .
- 4) Install control box cover ① .
- 5) Fix control box cover with the washers, spring washers and nuts ④ .

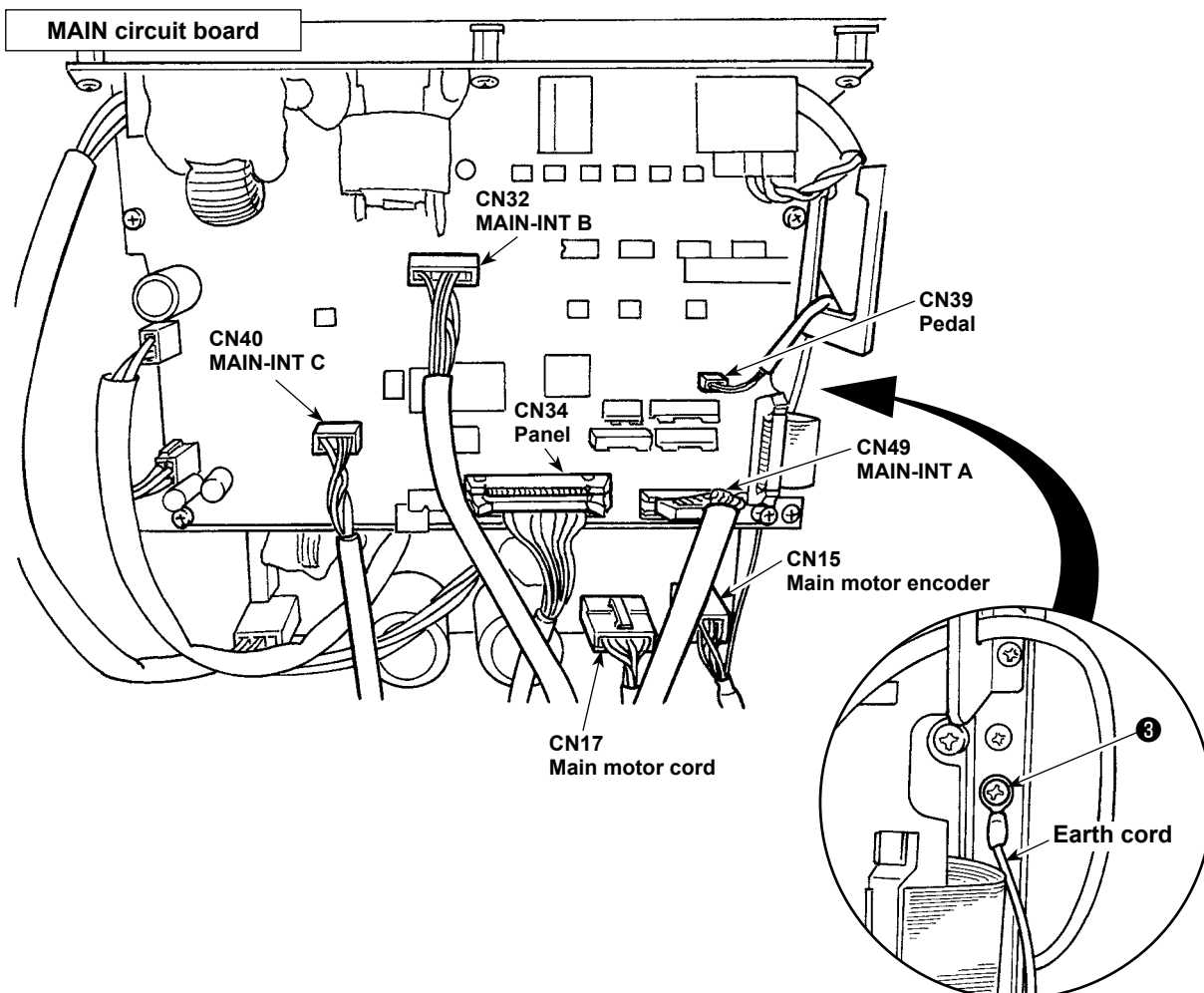
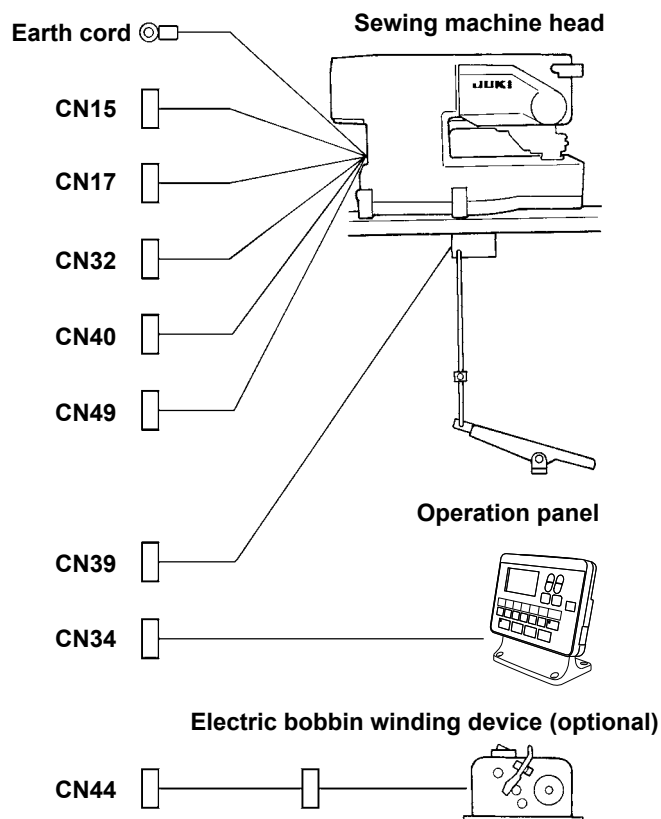

(15) Managing the cord

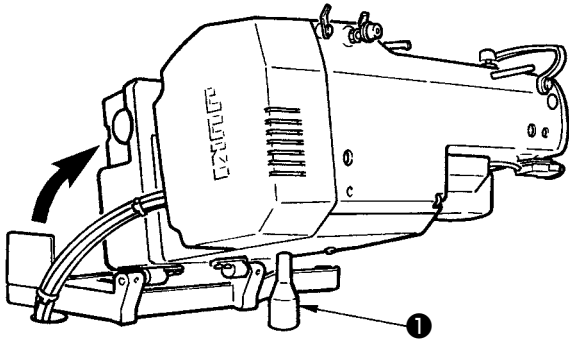

- 1) Slowly tilting the sewing machine, check that the cords are not forcibly pulled.



When you tilt the sewing machine, make sure that the sewing machine head support bar ① is placed on the table.

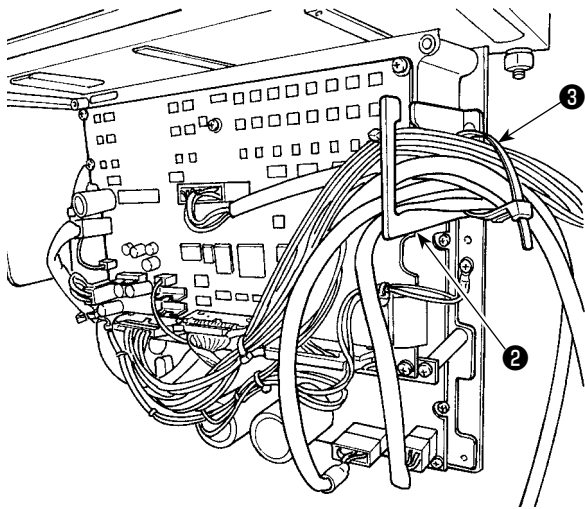

- 2) Bring the cords under the table into the control box.
- 3) Put the cord brought into the control box through cord exit plate ② and fix cable clip band ③ .

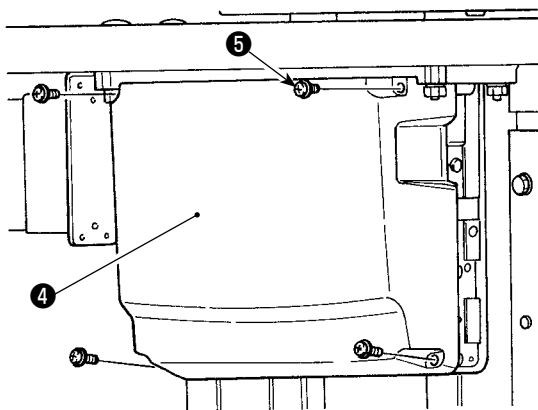

- 4) Install control box lid ④ with four set-screws ⑤ .

(16) Installing the eye protection cover



WARNING :

Be sure to attach this cover to protect the eyes from the disperse of needle breakage.

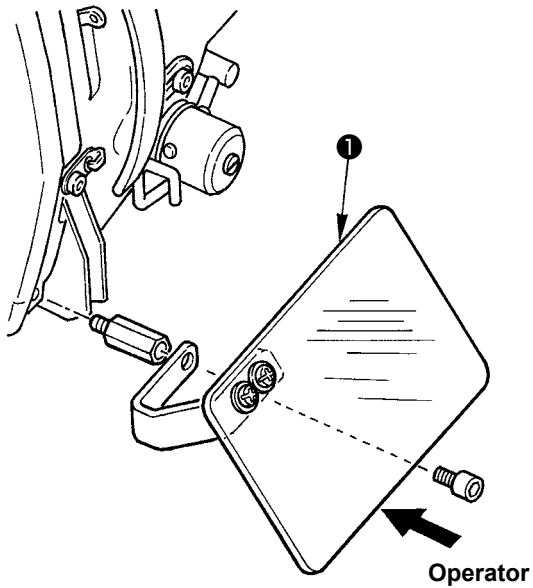

Be sure to install and use eye protection cover ❶ and use the sewing machine.

(17) Fixing the temporary stop switch

The temporary stop switch has been factory-set in state **A** at the time of shipment. Loosen setscrews ❶ and fix mounting plate ❸ with setscrews ❶. Then, fix the switch on mounting plate ❸ with accessory setscrews ❷.

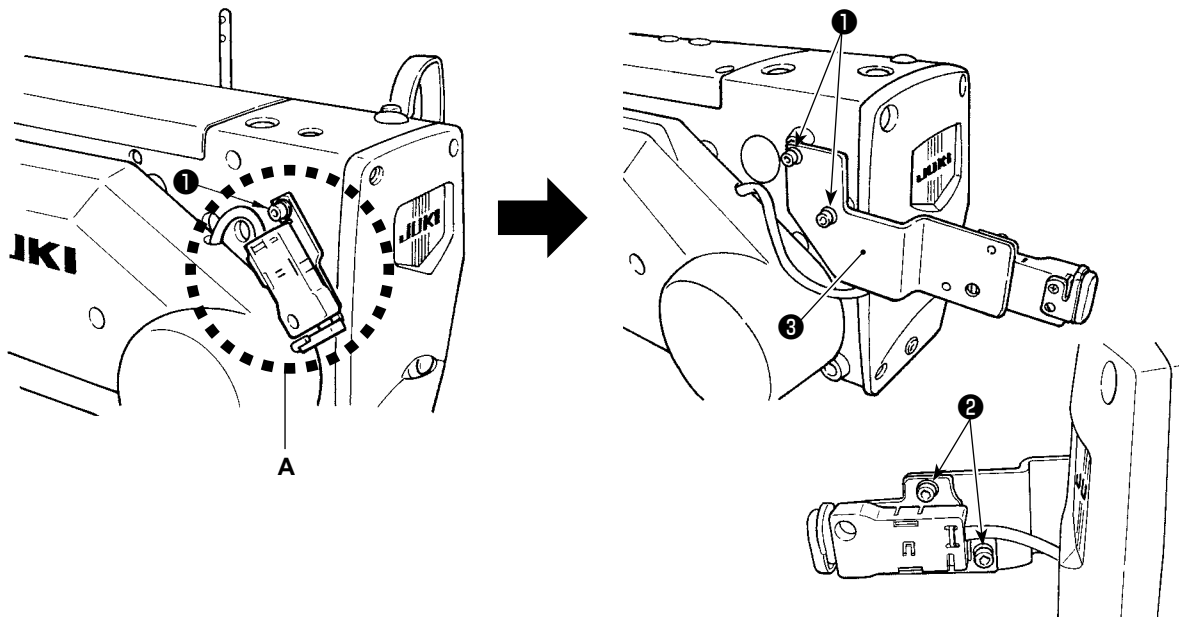

(18) Thread guide rod

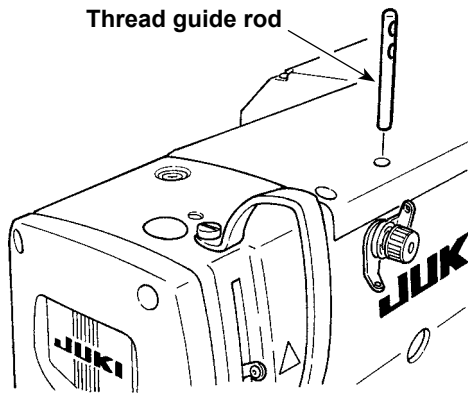

Securely fit the thread guide rod so that two side holes in the thread guide rod face the thread guide.

(19) Installing the thread stand

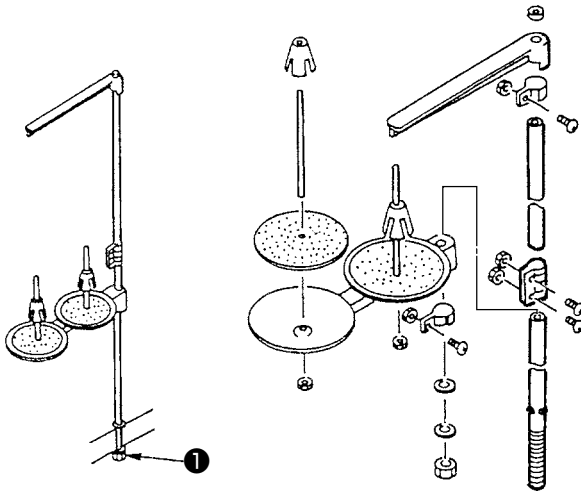

- 1) Assemble the thread stand, and set it in the hole in the top right corner of the machine table.
- 2) Tighten locknut ❶ to fix the thread stand.

IV. PREPARATION BEFORE OPERATION

1. Lubrication



WARNING :

To protect against possible personal injury due to abrupt start of the machine, be sure to start the following work after turning the power off and ascertaining that the motor is at rest.

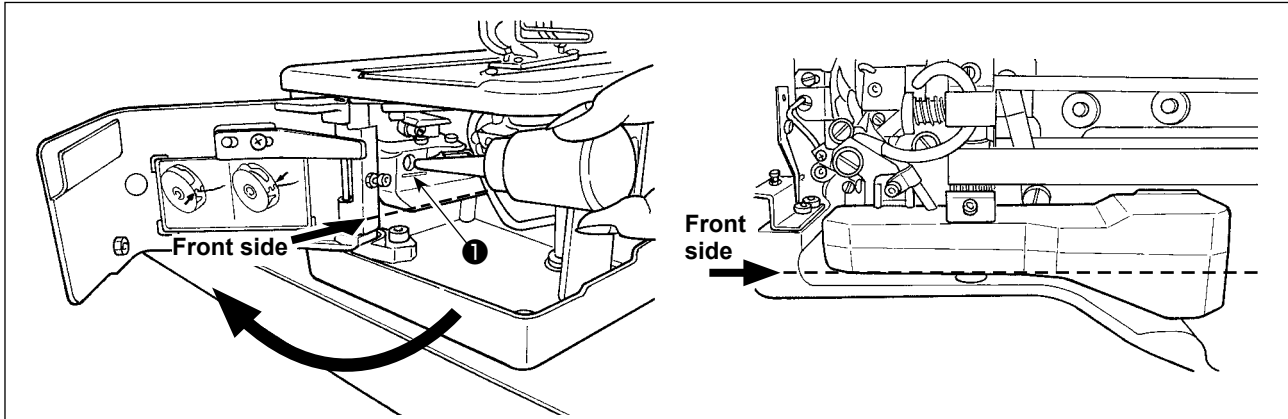

1) Lubricating oil to oiling tank

- Fill the oiling tank with JUKI New Defrix Oil No.1 up to the level indicated by "MAX" ❶. When supplying oil to the oil tank through the lubricating hole, take care not to allow dust to enter the oil tank.
- Supply oil in the case the oil cannot be visually observed from the front side of the oil tank.

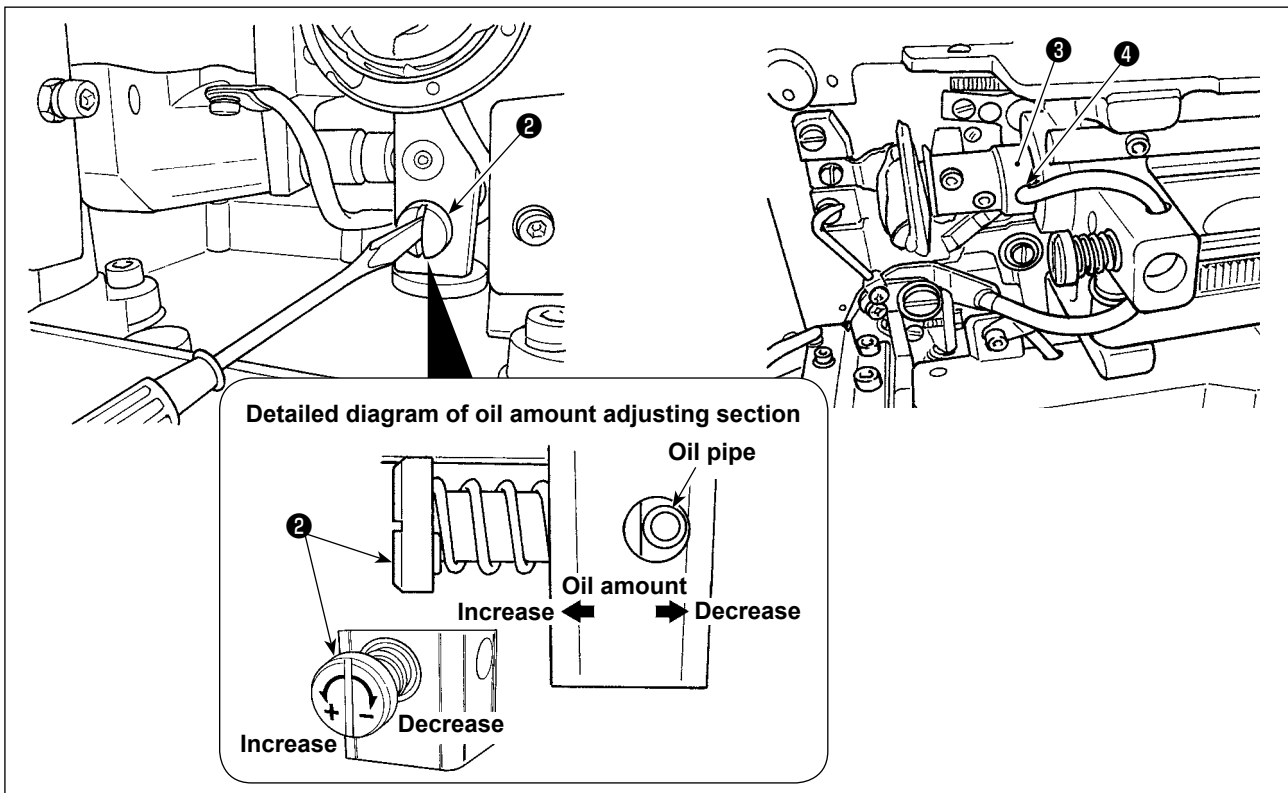

2) Adjusting the lubrication for the sewing hook

- The amount of oil is adjusted with oil amount adjusting screw ❷.
- Amount of supplied oil is reduced when turning the screws ❷ clockwise.
- When you first operate your sewing machine after set-up or after an extended period of disuse, remove the bobbin case and apply a few drops of oil to the hook race. In addition, apply a few drops oil from oiling hole ❹ in hook driving shaft front metal ❸ to soak the inside felt in oil.

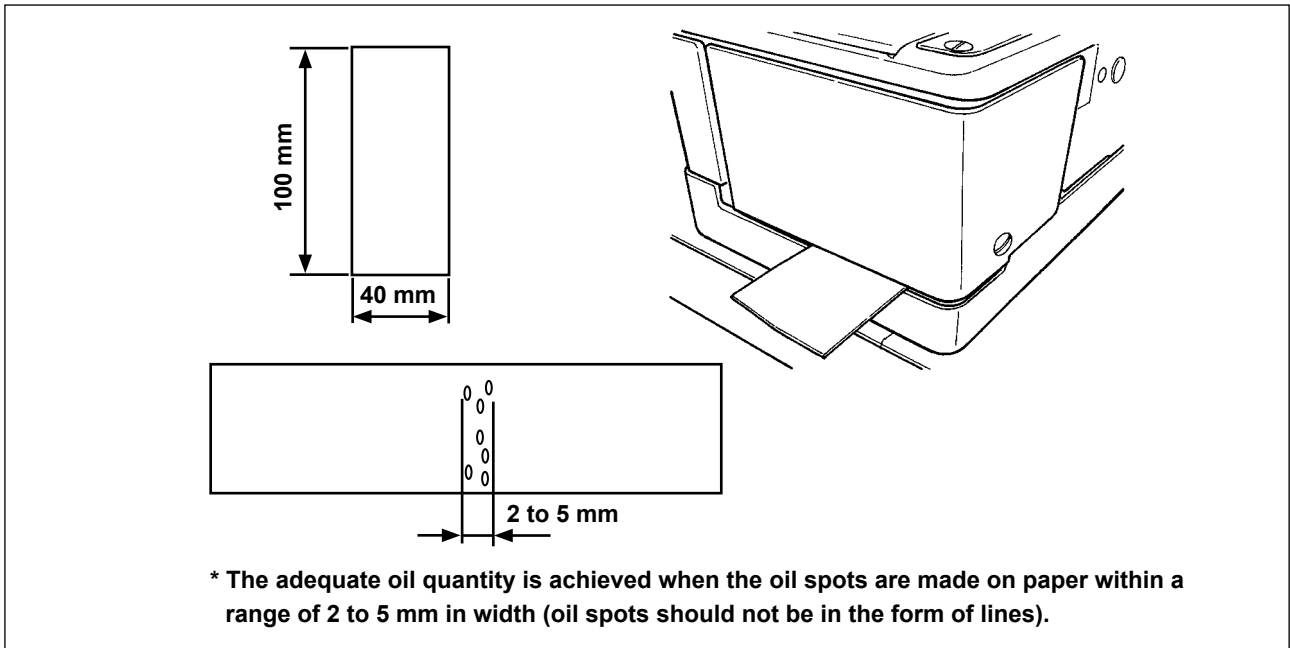

3) How to check the hook oil quantity

1. In preparation for checking the hook oil quantity, cut a sheet of paper to make a piece of paper size of which is approximately 40 mm × 100 mm.
2. After the adjustment of the oil quantity, start the sewing machine at a high speed (3,600 sti/min) by 100 times or more.
3. Insert the piece of paper prepared in Step 1 into the clearance provided between the hook cover and the bed base so that it is placed near the underside of the hook.
As a guide, insert the paper until it comes in contact with the hook oil shield.
4. Supporting the paper with hand, run the sewing machine by five cycles using the standard pattern (3,600 sti/min) and check the splashing oil quantity.

Caution In the case the oil quantity is too much even after the oil controlling screw is fully tightened, remove the hook shaft coupling and cut off the excess of oil wick.

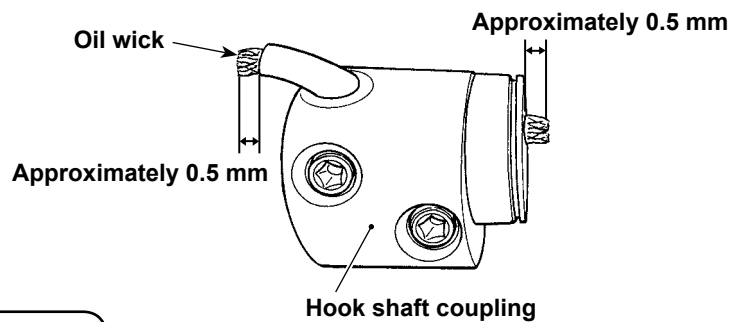

2. Inserting the needle

WARNING :
To protect against possible personal injury due to abrupt start of the machine, be sure to start the following work after turning the power off and ascertaining that the motor is at rest.

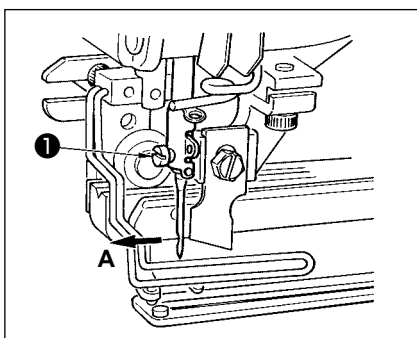

Hold needle with its recessed part facing toward the operator side **A**, insert the needle fully into the needle clamping hole, and tighten needle setscrew **1**. Use a DP×5 (#11J, #14J).

Caution When attaching the needle, turn OFF the power to the motor.

3. Threading the needle-thread



WARNING :

To protect against possible personal injury due to abrupt start of the machine, be sure to start the following work after turning the power off and ascertaining that the motor is at rest.

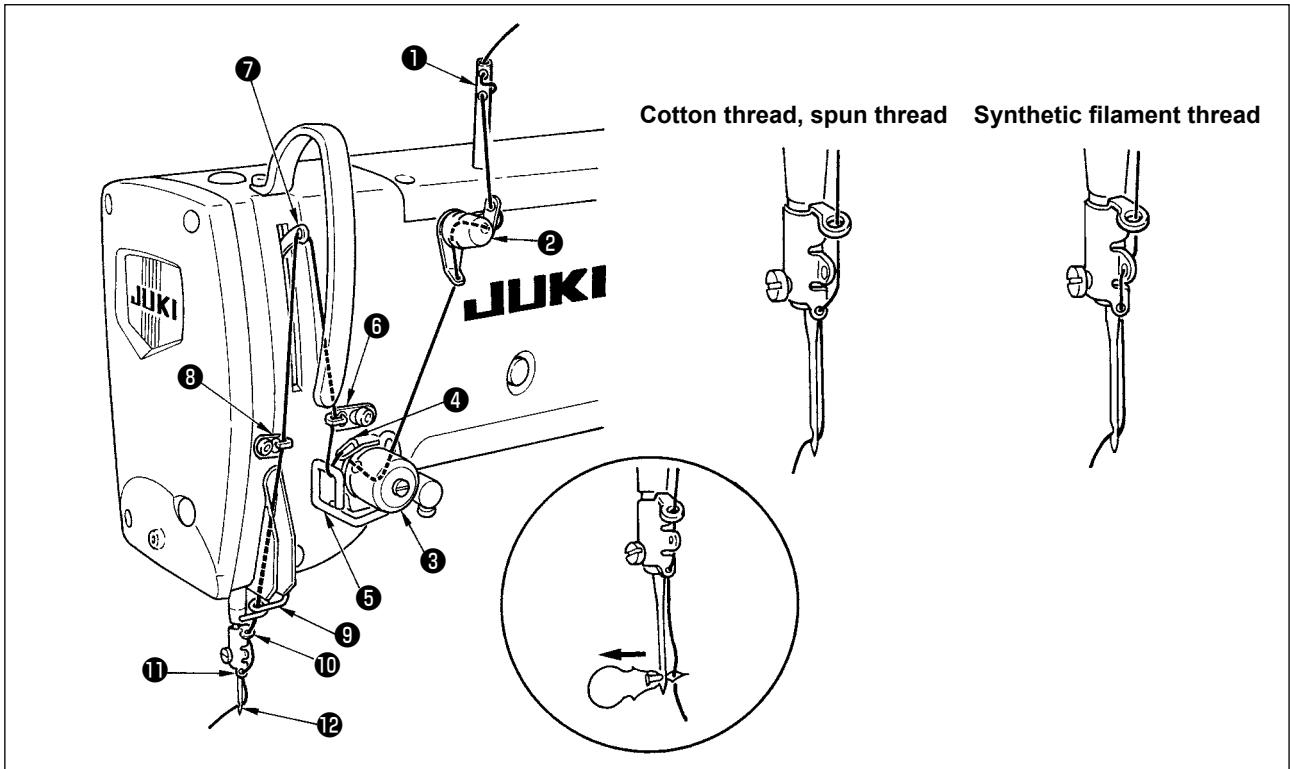

Pass the needle thread in the order ① to ⑫ as shown in the figures.

The threading can be done easily by using the needle threader supplied with the machine.

Change the thread guide threading method according to the thread to be used.

4. Threading the bobbin case

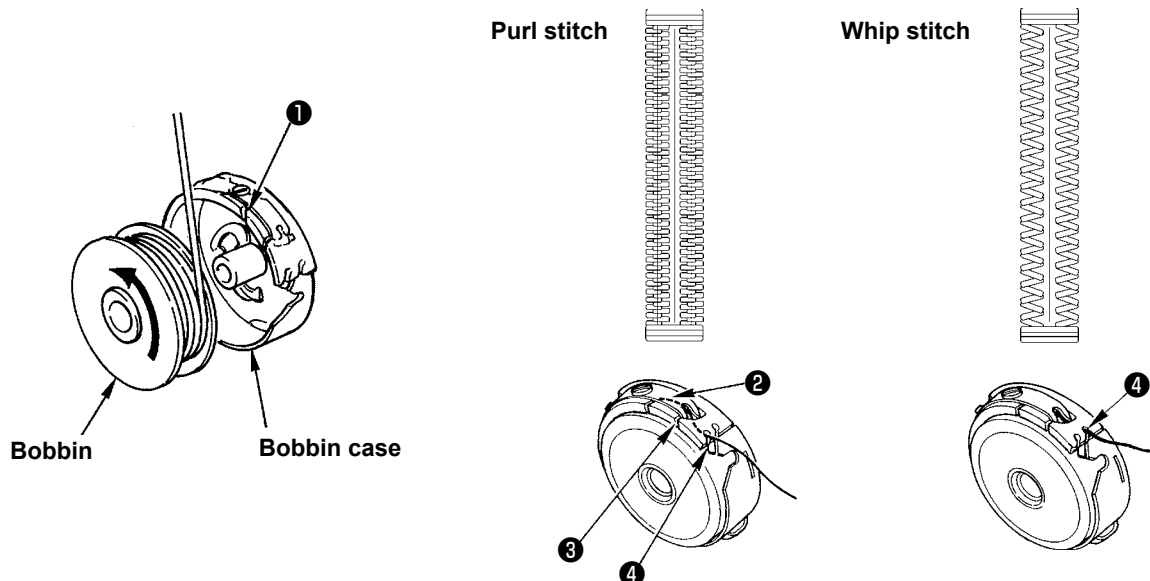

Rotating direction of bobbin and threading

- 1) Fit the bobbin so that it rotates in the direction of the arrow.
- 2) Pass the thread through thread slit ①, then through under the tension spring ②, again through thread slit ③, and pull the thread from ④.
- 3) Threading at ④ for purl stitching is different from that for whip stitching. So, be careful.

5. Adjusting the bobbin thread tension

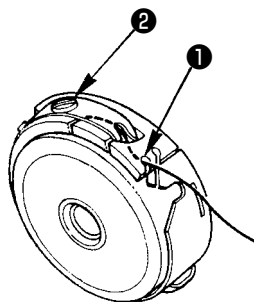

Adjust the bobbin thread tension as given below when the bobbin thread is pulled up at the position where thread slit ① of bobbin case comes up.

Purl stitch	0.05 to 0.15N	To such an extent that bobbin case quietly comes down when holding thread end coming from bobbin case and shaking it quietly up and down.
Whip stitch	0.15 to 0.3N	To such an extent that bobbin case barely comes down when holding thread end coming from bobbin case and shaking it somewhat strongly.

Turning tension adjust screw ② clockwise will increase bobbin thread tension, and turning it counterclockwise will decrease the tension.

Adjust the bobbin thread tension to lower for synthetic filament thread, and to higher for spun thread. The thread tension is higher by approximately 0.05N when the bobbin case is set to the hook since idle-prevention spring is provided.



When bobbin thread tension is adjusted, check the needle thread tension setting of the memory switch. (Refer to "V-22. Memory switch data list" p.64.)

6. Installation of bobbin case



WARNING :

To protect against possible personal injury due to abrupt start of the machine, be sure to start the following work after turning the power off and ascertaining that the motor is at rest.

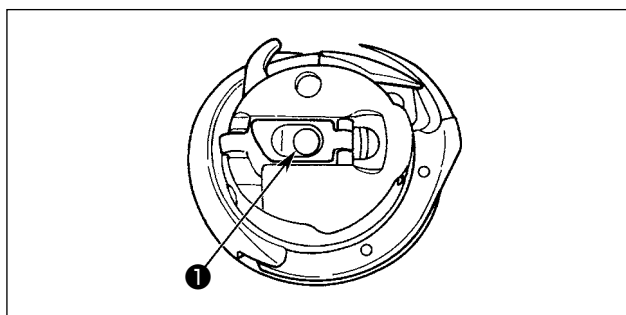

- 1) Lift up and hold bobbin case latch lever between two fingers.
- 2) Push the bobbin case into the hook so that it is supported by the hook shaft ① and then snap in the latch lever.

Press the bobbin case until the predetermined position is reached, and it will click.



1. If the bobbin case is out of the predetermined position, it can jump out from the hook to cause the needle thread to tangle on the hook shaft. Check to be sure that the bobbin case is properly installed in the correct position.
2. There is a difference in the shape of bobbin case between the standard hook and the dry one. They have nothing in common with each other.

7. Installing the knife



WARNING :

To protect against possible personal injury due to abrupt start of the machine, be sure to start the following work after turning the power off and ascertaining that the motor is at rest.

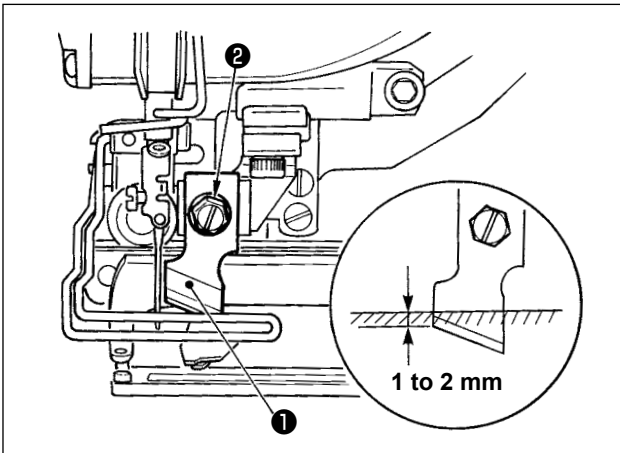

When replacing the knife with a new one, perform as follows.

- 1) Knife ① can be easily removed together with the washer when removing knife retaining screw ② .
- 2) Lower the knife bar by hand. Now, push the knife bar down so that the knife goes below the top surface of the throat plate by 1 to 2 mm, as illustrated in the figure. In this state, place the washer and tighten the setscrew.

Inch → mm CONVERSION TABLE

Knife size	Indication of mm
1/4	6.40
3/8	9.50
7/16	11.10
1/2	12.70
9/16	14.30
5/8	15.90
11/16	17.50
3/4	19.10
13/16	20.60
7/8	22.20
1	25.40

When the cloth cutting knife you have is indicated in inch, set the cloth cutting length (knife size) in mm using the inch → mm conversion table. (Refer to "[V-12. Sewing data list](#)" p.43.)

8. Item to be checked before turning the power ON

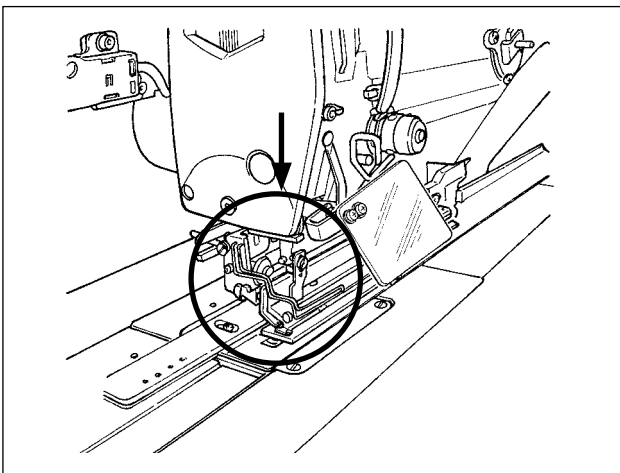

If the work clamp foot is the lifted state before turning the power ON, lower it firstly and turn ON the power to the sewing machine.











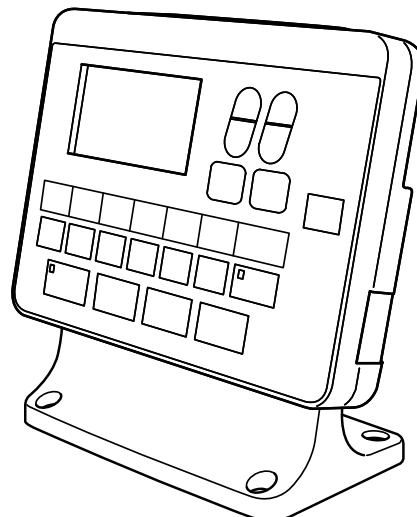
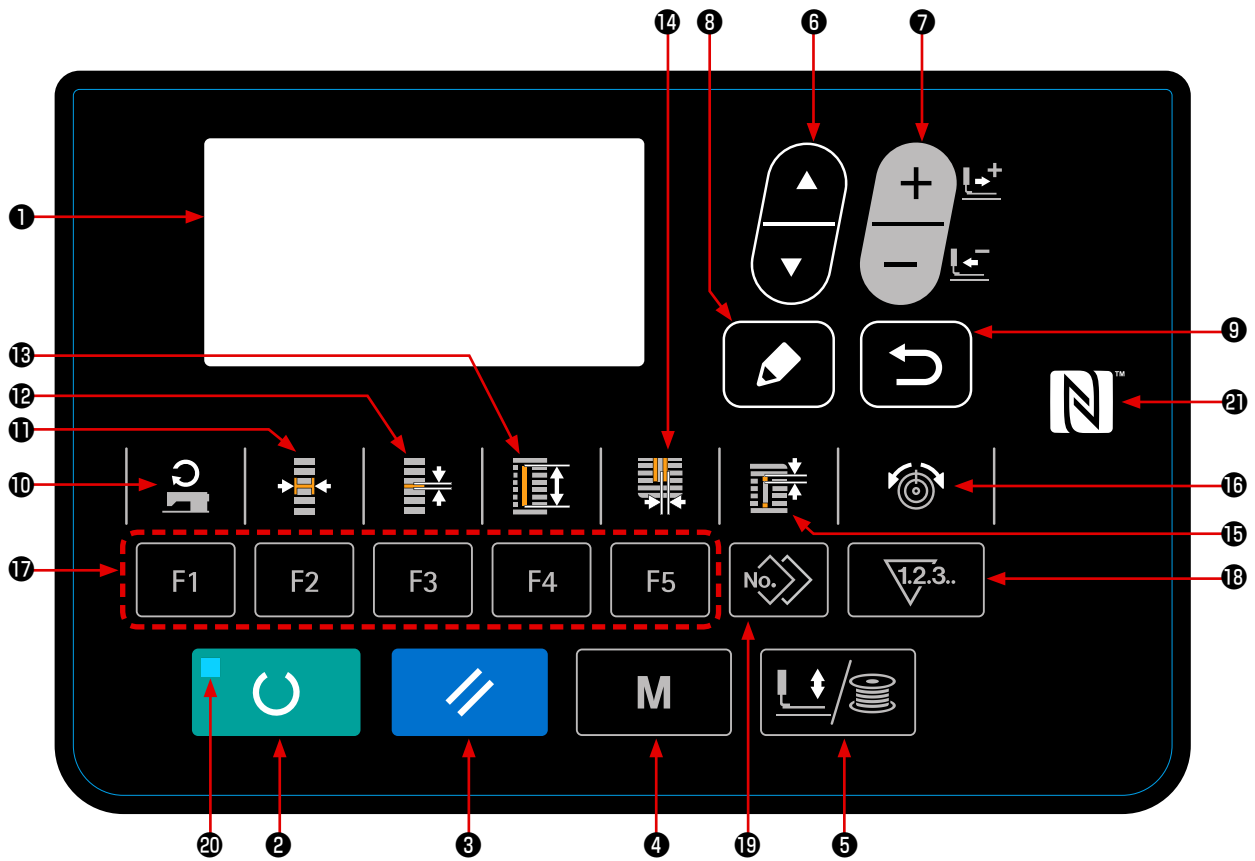











When lowering the work clamp, take care not to place your hands near the knife.

If the power is turned ON with the work clamp raised and the READY key is pressed, "E998 Work clamp deviation error" can occur.

V. OPERATION OF THE SEWING MACHINE

1. Explanation of the operation panel switch



No.	NAME	FUNCTION	No.	NAME	FUNCTION
①	LCD display	Various data such as pattern No., shape, etc. are displayed.	⑬	CLOTH CUT LENGTH key 	This key selects cloth cut length display.
②	READY key 	Press this key when starting sewing. Every time this key is pressed, change-over of sewing ready set state and data set state can be performed.	⑭	KNIFE GROOVE WIDTH key 	This key is used to select the knife-groove width correction display. Every time this key is pressed, S003 (right) and S004 (left) are displayed alternately.
③	RESET key 	Press this key when releasing error, travelling the feed mechanism to its initial position, counter resetting, etc.	⑮	CLEARANCE key 	This key selects clearance display. Every time this key is pressed, S022 (first clearance) and S023 (second clearance) are displayed alternately.
④	MODE key 	This key is used for displaying the mode screen.	⑯	THREAD TENSION key 	This key is used to select the thread tension display. Every time this key is pressed, the display item is changed over as described below: S052 Thread tension at the right parallel section S053 Thread tension at the left parallel section (first cycle of double stitching) S054 Thread tension at the right parallel section (first cycle of double stitching) S055 Thread tension at the first bartacking section S056 Thread tension at the second bartacking section
⑤	PRESSER and WINDER key 	This key lifts or lowers the presser. When the presser goes up, the needle bar travels to the origin and when it comes down, the needle bar travels to the right. This key is pressed when performing bobbin winding.	⑰	PARAMETER REGISTRATION key 	This is a short cut key that parameter registration is available. Registration of shortcut to setting display of an optional pattern, sewing parameter or adjustment data is possible. For the setting procedure, Refer to " V-15. Using parameter register key " p.52.
⑥	ITEM SELECT key 	This key is used to select the data No. and other kinds of data.	⑱	COUNTER key 	This key selects counter display.
⑦	DATA CHANGE key 	This key is used to change the pattern No. and other kinds of data. This key is used to move the feed forward on a stitch-by-stitch basis.	⑲	COPY key 	Press this key when copying pattern.
⑧	EDIT key 	This key is used to display the edit screen, to select the item or to display the detail screen.	⑳	SET READY LED	It lights up under the sewing mode.
⑨	RETURN key 	This key is used to return the screen to the previous one.	㉑	NFC mark 	Bring the tablet or smartphone close to the NFC mark when carrying out communication.
⑩	SEWING SPEED key 	This key is used to display the parameter edit items related to the sewing speed.			
⑪	OVEREDGING WIDTH key 	This key selects overedging width display. Every time this key is pressed, S005 and S006 are displayed alternately.			
⑫	PITCH key 	This key selects pitch of parallel section. Every time this key is pressed, S007 and S021 are displayed alternately.			

2. Basic operation of the sewing machine

1) Select the model of your sewing machine.

When you turn the power ON for the first time after the purchase of your sewing machine, the model confirmation screen is displayed. Press

READY key  .

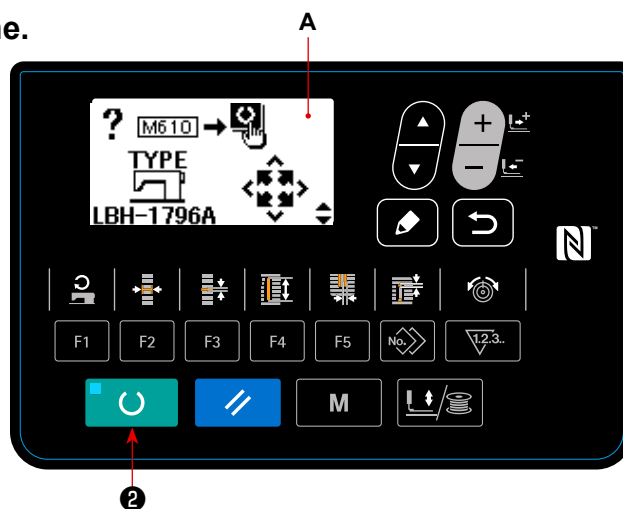

When Error E001 screen **B** is displayed, turn the power OFF.

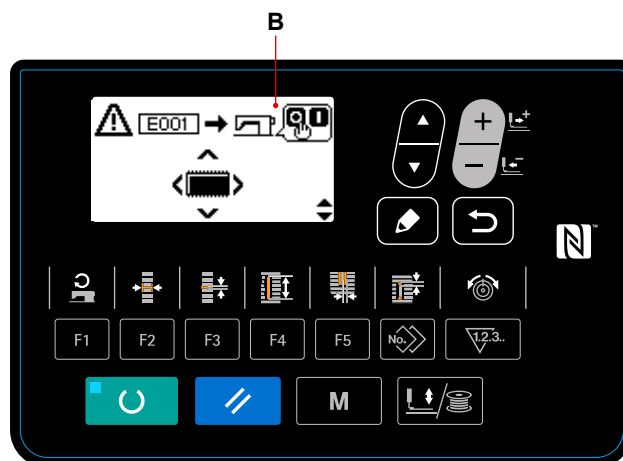

* In the case the power-OFF screen **C** is displayed after the completion of procedure described in 1), turn the power OFF once. Then, carry out the procedure described 1) again.

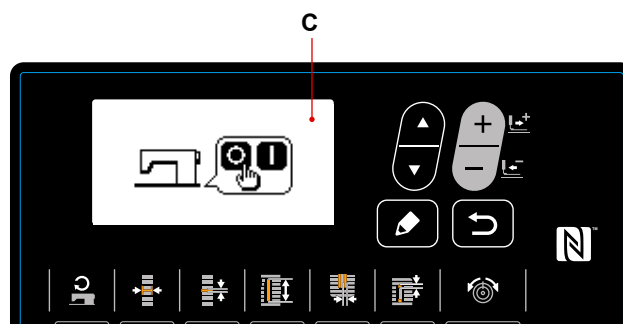

2) Selecting the language.

When you turn the power ON for the first time after the completion of procedure described in 1), the language selection screen **A** is displayed.

Select the language to be displayed, then press

RETURN key **9** .



If you terminate the language selection by pressing RETURN key

9  without selecting the language, the language selection screen will be displayed every time you turn ON the power to the sewing machine.

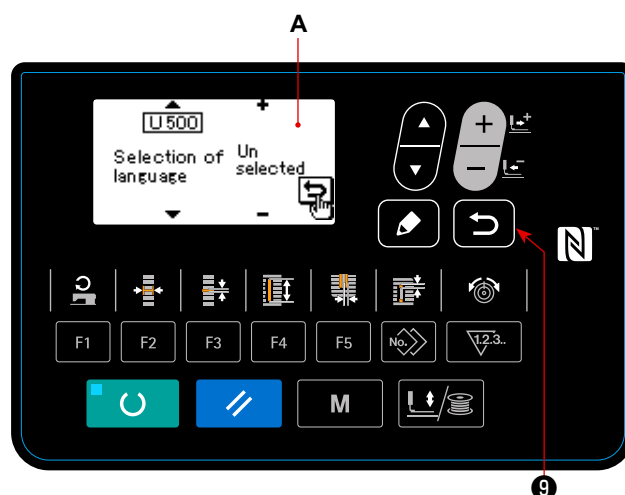

3) Select the pattern No. you desire to sew.

When you turn the power ON, the currently-selected pattern No. **B** and pattern data name **C** are displayed.

When you desire to change it, press DATA

CHANGE key **7**  and select the No. you

desire to sew. When you purchase the sewing machine, pattern No. 1 to 10 described in "**V-10. Changing sewing data**" p.40 have been registered. Select the pattern No. you desire to sew from among these numbers. (The No. with which the pattern has not been registered is not displayed.)

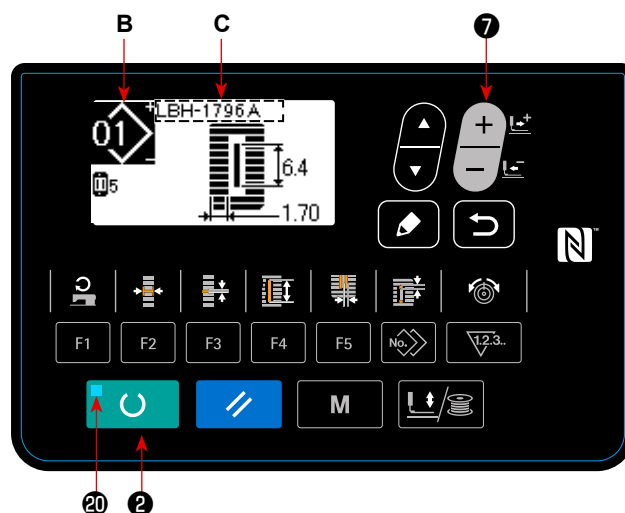

4) Set the sewing machine to sewing possible state.

When READY key **2**  is pressed, SET READY LED **20** lights up to show that the sewing is enabled.

5) Start sewing.

Set the sewing product to the presser portion, and operate the pedal to start the sewing machine, and sewing starts.

The pedal type of the sewing machine has been factory-set to the 1-pedal type at the time of shipment. However, the pedal operation method can be selected from among four different ones. Select the operating procedure you desire and use the sewing machine.

→ Refer to "**V-3. How to use the pedal**" p.30.

3. How to use the pedal



For this sewing machine, the pedal operation method to be used can be selected from among the four different ones. Select the operating procedure you desire for working efficiency and use the sewing machine.

(1) Setting procedure of the pedal type

1) Call the pedal type setting parameter.

Keep MODE key **4** **M** held pressed for three seconds under the input mode where SET READY LED **20** goes out. Then, the MEMORY switch (level 2) is displayed on the menu.

Select the target item with ITEM SELECT key

6  and press EDIT key **8** . Then, the

memory switch (level 2) edit screen **A** is displayed.

When the pedal type selection parameter **K001**

is not displayed, press ITEM SELECT key **6** 

to select the pedal type.

2) Select the pedal type.

Press DATA CHANGE key **7**  and the pic-

ture is changed as shown in the illustration below. Select the pedal type **B** you desire.

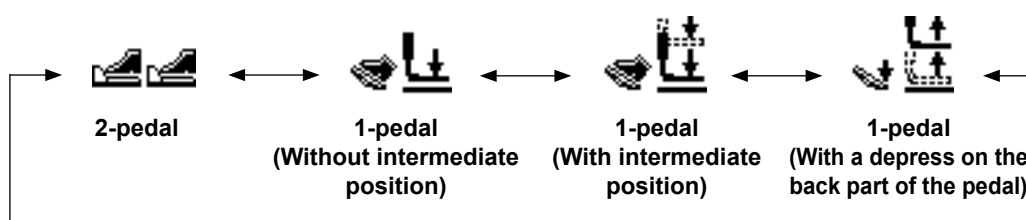
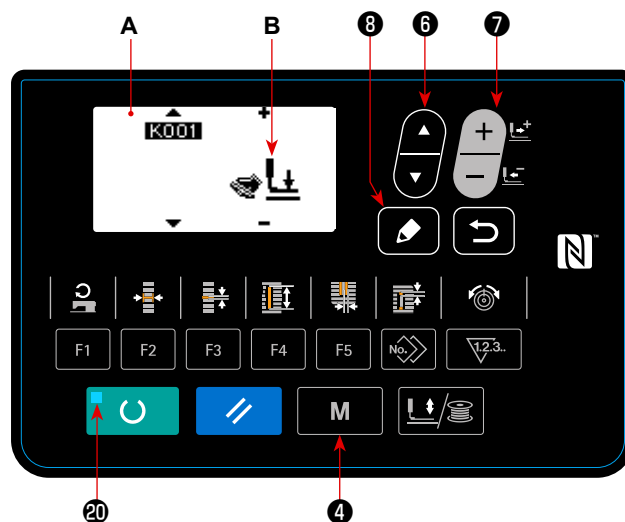

3) PK pedal (to be used for operating the sewing machine in a standing position)

PK pedals below can be connected to the machine.

Name of part	JUKI Part No.	Remarks
PK-51	GPK510010B0	2-pedal type for standing work
PK-57	GPK570010B0	1-pedal 2-step type for standing work

When using PK pedal, the relay cord below is necessary.



Name of part	JUKI Part No.	Remarks
PK pedal relay cord (asm.)	40003493	Common to PK-51 and PK-57

1. Connecting procedure

- (1) Remove connector CN41 (white • 6P) of MAIN board in the control box. The connector which has been removed is the connector of the pedal provided as standard. Use it in case of need.
- (2) Connect connector (CN41) of the relay cord to CN41.
- (3) Connect connector (CN71) of the relay cord with the connector of PK pedal. In case of PK-51, the connection is completed with the work above. Besides, in case of PK-57, the earth line protrudes at the connector section. However, it is not necessary to connect it.
- (4) In case of PK-57, remove the cover and perform the change of connection of the micro switch located inside the pedal. Change the connection of micro switch (upper side) in which the switch button is pressed when the pedal is set to free from NC (normal close) to NO (normal open).

2. When using PK pedal, perform the following operation.

- (1) Enable to select the PK pedal.
Display the mode screen while turning ON the DIP switch 2 of the panel board.
- (2) Select to PK pedal.
Select PK pedal by K001 (pedal selection) of memory switch level 2 setting screen.

Display	Pedal selection
 PK51	Select PK-51
 PK57	Select PK-57

(2) Explanation of pedal motion

<u>2-pedal type</u>	<u>1-pedal (Without intermediate position)</u>	<u>1-pedal (With intermediate position)</u>	<u>1-pedal (With a depress on the back part of the pedal)</u>
<p>Initial position Presser : <u>Intermediate position ②</u> or <u>Cloth setting position ③</u></p> <p>1) Setting of sewing product Presser goes up as high as the pedal toe down amount of the left side pedal.</p> <p>2) Start of Sewing Sewing starts when the right side pedal is depressed.</p> <p>3) End of sewing Presser automatically goes up to <u>Intermediate position ②</u> .</p>	<p>Initial position Presser : <u>Maximum position ①</u></p> <p>1) Setting of sewing product</p> <p>2) Confirmation of setting of sewing product Presser comes down to <u>Cloth setting position ③</u> when the first step of the pedal is depressed.</p> <p>3) Start of Sewing Sewing starts when the second step of the pedal is depressed.</p> <p>4) End of sewing Presser automatically goes up to <u>Maximum position ①</u> .</p>	<p>Initial position Presser : <u>Maximum position ①</u></p> <p>1) Setting of sewing product</p> <p>2) Confirmation of setting of sewing product Presser comes down to <u>Intermediate position ②</u> when the first step of the pedal is depressed.</p> <p>3) Confirmation of start of sewing Presser comes down to <u>Cloth setting position ③</u> when the second step of the pedal is depressed.</p> <p>4) Start of Sewing Sewing starts when the third step of the pedal is depressed.</p> <p>5) End of sewing Presser automatically goes up to <u>Maximum position ①</u> .</p>	<p>Initial position Presser : <u>Intermediate position ②</u></p> <p>1) Setting of sewing product</p> <p>2) Confirmation of setting of sewing product When the back part of the pedal is depressed, the presser foot goes up to <u>Maximum position ①</u> . When the pedal is depressed to the first step of its stroke, the presser foot comes down to <u>Intermediate position ②</u> . When the pedal is depressed to the second step of its stroke, the presser foot comes down to <u>Cloth setting position ③</u> .</p> <p>3) Start of Sewing Sewing starts when the third step of the pedal is depressed.</p> <p>4) End of sewing Presser automatically goes up to <u>Intermediate position ②</u> .</p>

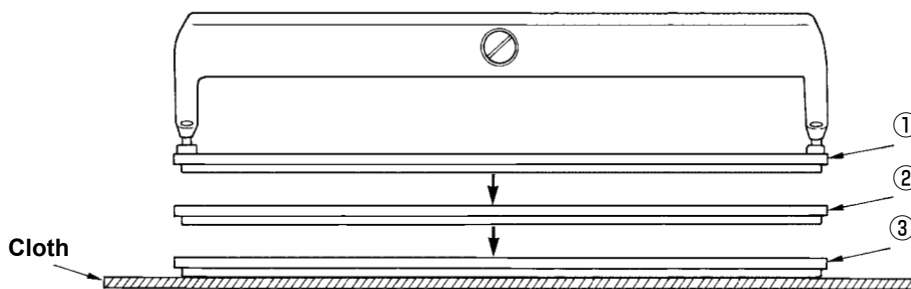

* Height of the respective positions of ① to ③ described on the left side can be set or changed by the memory switches.

→ Refer to "[V-21. Method of changing memory switch data](#)" p.63.

• Pedal switch setting (In the case the optional 2-pedal switch (part number: 40003491) is used)

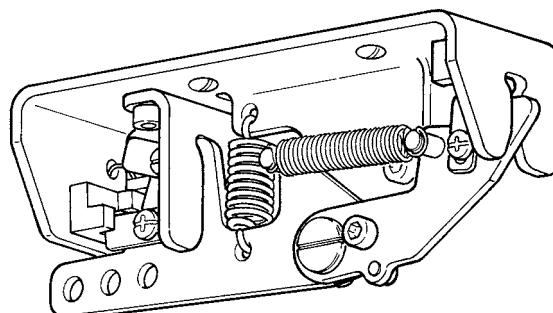

4. Performing pattern selection

(1) Selection from the pattern selection screen

1) Set the mode to the input mode.

Under the input mode where SET READY LED ⑳ goes out, pattern selection is enabled.

If the current mode is the sewing mode, press READY key ②  to change over the mode to the input mode.

2) Call the pattern selection screen.

Pattern No. A which is currently selected is displayed.

3) Select the pattern.

Press DATA CHANGE key ⑦ , and the

patterns which have been registered are changed over in order and displayed. Here, select the No. you desire to sew.

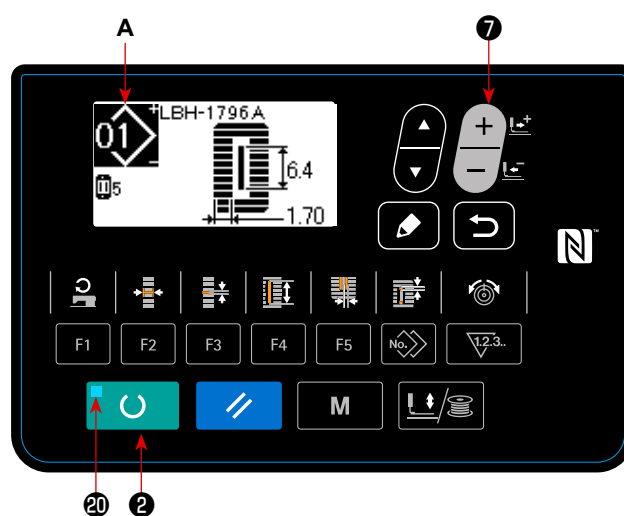

(2) Selection by means of the register key

For this sewing machine, it is possible to register a desired pattern No. to the PARAMETER REGISTER key.

When the pattern is registered once, pattern selection can be performed by pressing only the switch.

→ Refer to "[V-15. Using parameter register key](#)" p.52.

5. Changing needle thread tension

Needle thread tension can be changed while performing trial sewing since the data related to the needle thread tension can be set by the sewing mode as well.

1) Call thread tension at parallel section setting data.

When THREAD TENSION key **16**  is pressed, the sewing data edit screen **A** is displayed.

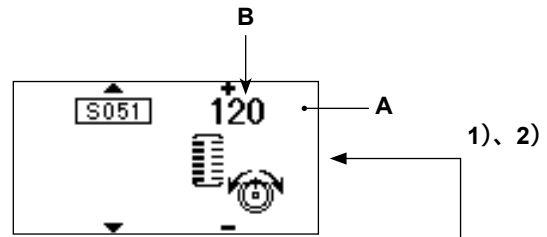

2) Change thread tension at parallel section.

Press DATA CHANGE key **7** , and set value **B** goes up or comes down and the thread tension can be changed. The relation between the finish of sewing and the set value is as shown in the illustration below. Set the value referring to the illustration.

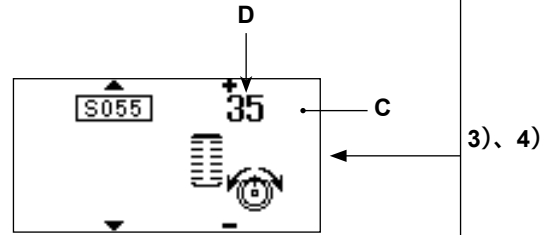

3) Call thread tension at bar-tacking section setting data.

When THREAD TENSION key **16**  is pressed again, the sewing data edit screen **C** is displayed.

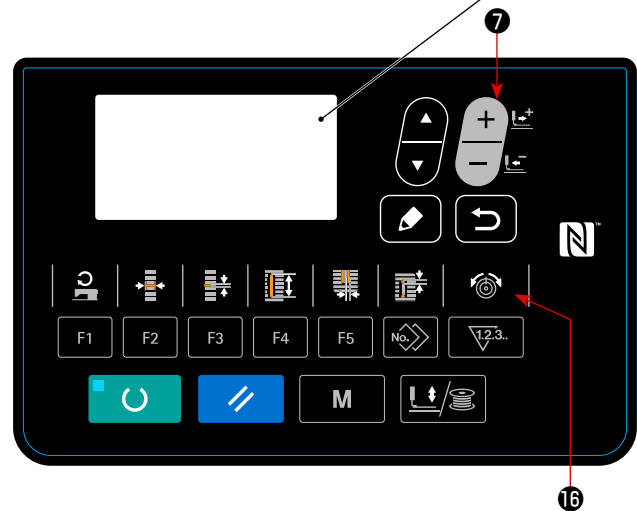

4) Changing the needle thread tension at bar-tacking section.

Press DATA CHANGE key **7** , and set value **D** goes up or comes down and the thread tension can be changed. The relation between the finish of sewing and the set value is as shown in table below. Set the value referring to the table.



* For the tension other than that at parallel section and bar-tacking section, refer to "[V-10. Changing sewing data](#)" p.40 and "[V-21. Method of changing memory switch data](#)" p.63.

Set value of tension at ① parallel section and ② bar-tacking section

		Set value on panel		
			Initial value	
Purl stitch	① Tension at parallel section	Crest is lowered.	120	Crest is raised.
	② Bar-tacking tension	Thread tension is decreased.	35	Thread tension is increased.
Whip stitch	③ Tension at parallel section	Thread tension is decreased.	60	Thread tension is increased.
	④ Bar-tacking tension	Thread tension is decreased.	60	Thread tension is increased.

For the eyelet radial shape, set the bar-tacking tension first to approximately 120 and make the balance of stitches.

Purl stitch and Whip stitch

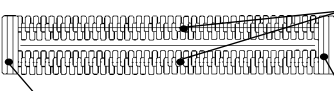
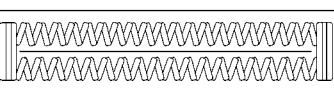
	Purl stitch When applying higher tension to the needle thread to permit it to pass straight through fabric, the purl stitch is formed by the bobbin thread which is pulled over from both sides to the center line.
	Whip stitch The whip stitch is formed in zigzag showing the needle thread only on top of fabric, and the bobbin thread on the bottom.

6. Performing re-sewing

When stop switch **A** is pressed during sewing operation, the sewing machine interrupts sewing and stops. At this time, error display screen **B** is displayed to inform that the stop switch is pressed.

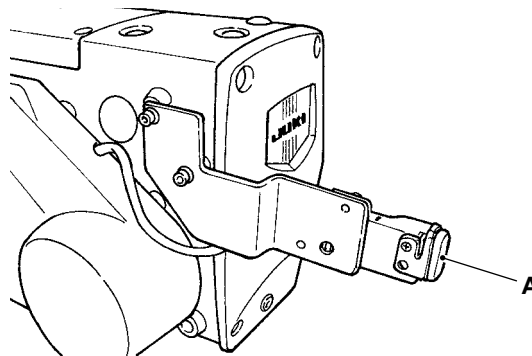

To continue performing sewing from some point in sewing

Sewing motion stop status

Error display screen **B** is displayed.

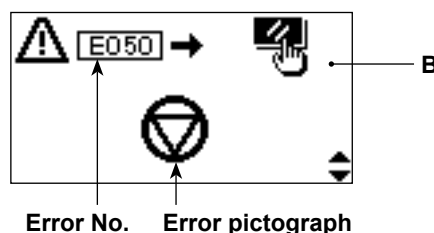

1) Release the error.

Press RESET key **3**  to release the error.

Then step motion screen **C** is displayed.

2) Return the presser.

Press BACKWARD key **7-1**  and the presser returns stitch by stitch.

Press FORWARD key **7-2**  and the presser advances stitch by stitch. Return the presser to the re-sewing position.

3) Start sewing again.

Depress the right side pedal and sewing starts again.

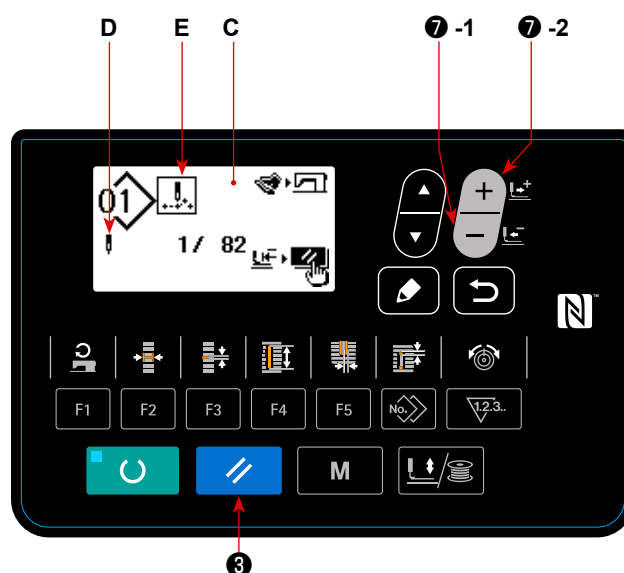

To perform re-sewing from the start

Sewing motion stop status

Error display screen **B** is displayed.

1) Release the error.

Press RESET key **3**  to release the error.

Then step motion screen **C** is displayed.

2) Return the presser to the sewing product setting position.

Press again RESET key **3**  and the presser returns to the sewing product setting position.

3) Perform again the sewing work from the start.

* Existing number of stitches/total number of stitches are displayed in section D.

* Existing sewing command is displayed in section E.

Kinds of commands are :

Sewing command



Jump feed command



Thread trimmer command



Knife command



When you press the CLOTH CUTTING LENGTH key on the step operation screen, the material is brought to the knife dropping position. Then, you can manually lower the knife to check the knife dropping position. Use the CLOTH CUTTING LENGTH key for the aforementioned purpose.

7. Winding bobbin thread

(1) Winding the bobbin





In the case you wind the bobbin using presser and winder key **5** , remove the thread from the thread take-up lever and detach the bobbin from the hook.

1) Set the bobbin.

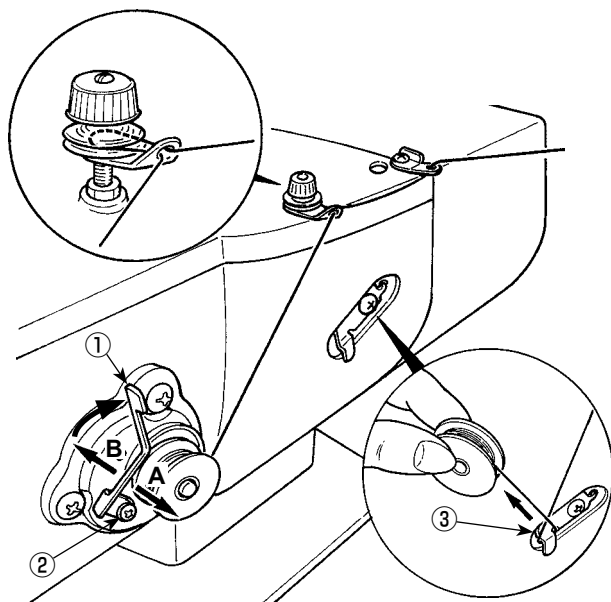
Fit a bobbin fully onto the bobbin winder shaft. Take the thread from the spool and pass it through the guides in the numerical order as shown in the figure, and wind the end of the thread several times around the bobbin. Then push the bobbin winding lever **1** in the direction of the arrow mark.



2) Set the mode to the bobbin winding mode.

Under the input state, press PRESSER and WINDER key **5** . In this state, press ITEM SELECT key **6** .

3) Start bobbin winding.

Depress the pedal, and the sewing machine rotates and starts winding bobbin thread.

4) Stop the sewing machine.

Once the bobbin is wound with the predetermined amount of thread, bobbin winding lever **1** is released. Press PRESSER and WINDER key **5**  or depress the pedal to stop the sewing machine. Then remove the bobbin and cut bobbin thread with thread trimmer retaining plate **3**.

- Press PRESSER and WINDER key **5** , and the sewing machine stops and returns to the normal mode.
- Depress the pedal and the sewing machine stops while the bobbin thread winding mode stays as it is. Use this way when winding bobbin thread around plural bobbins.

(2) Adjusting the amount to be wound on a bobbin.

To adjust the winding amount of the bobbin thread, loosen setscrew **2** and move the bobbin winding lever **1** to the direction of **A** or **B**. Then, tighten setscrew **2**.

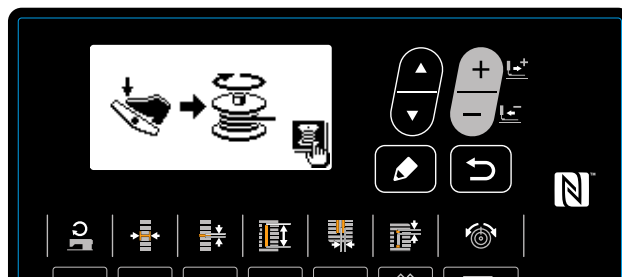
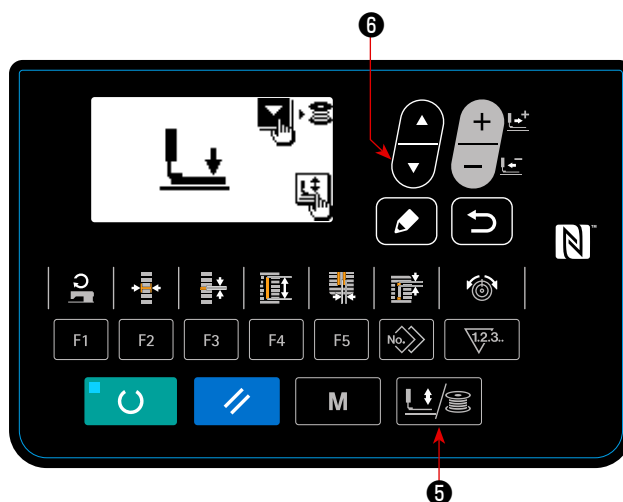

- To the direction of **A** : Decrease
- To the direction of **B** : Increase



8. Using the counter

(1) Setting procedure of the counter value

1) Call counter setting screen.

When COUNTER key ⑱  is pressed under the input mode where SET READY LED ⑳  goes out, the counter screen A is displayed to enable setting of the counter.

Setting of the counter value can be performed only with the input mode.

In case of the sewing mode, press READY key ②  to set the mode to the input mode.

 to set the mode to the input mode.

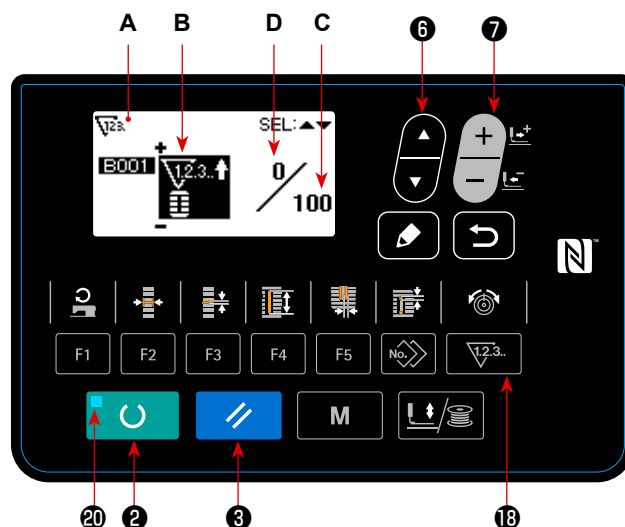



2) Selection of kinds of counters.

Press ITEM SELECT key ⑥  to display the pictograph B which indicates the counter type in reverse video.

Press DATA CHANGE key ⑦ , and select the counter you desire from among the kinds of counters below.

3) Change of counter set value.

Press ITEM SELECT key ⑥  to display the set value C of the counter in reverse video.

Press DATA CHANGE key ⑦  and input the set value until count-up is reached.

4) Change of existing counter value.

Press ITEM SELECT key ⑥  to display the current value D of the counter in reverse video.

Press RESET key ③  and the value on the way of counting can be cleared.

In addition, it is possible to edit the numerical value with DATA CHANGE key ⑦ .



The counter has been factory-set to "① Sewing UP counter" at the time of delivery. This counter has been factory-set so that it stops counting after the number of times of start of sewing machine has reached 100. Set this counter according to your conditions of use.

(2) Kind of counter



① Sewing UP counter

Every time the sewing of one shape is performed, the existing value is counted up. When the existing value is equal to the set value, count-up screen is displayed.



② Sewing DOWN counter

Every time the sewing of one shape is performed, the existing value is counted down. When the existing value is reached to "0", count-up screen is displayed.



③ No. of pcs. UP counter

Every time one cycle or one continuous stitching is performed, the existing value is counted up. When the existing value is equal to the set value, count-up screen is displayed.



④ No. of pcs. DOWN counter

Every time one cycle or one continuous stitching is performed, the existing value is counted down. When the existing value is reached to "0", count-up screen is displayed.



⑤ Counter not used

(3) Count-up releasing procedure

When count-up condition is reached during sewing work, the whole count-up screen **E** flashes on and off. Press RESET key  to reset the counter, and the mode returns to the sewing mode. Then the counter starts counting again.

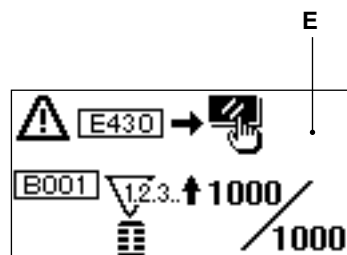

9. Using the initial value pattern

This sewing machine has the initial value to perform the optimum sewing for the sewing shapes (31 shapes).

→ Refer to **"XI. INITIAL VALUE DATA FOR EACH SHAPE TABLE" p.95.**

When creating sewing data newly, it is convenient to create it by copying the initial value pattern.



1) Set the mode to the input mode.

Under the input mode where SET READY LED ⑳ goes out, pattern change is enabled. If the current mode is the sewing mode, press READY key ㉑

 to change over the mode to the input mode.

2) Call initial value pattern.

The currently-selected pattern No. **A** is displayed.

Press DATA CHANGE key ㉑  to select initial value pattern .

3) Select shape.

The shape selection screen **B** is displayed to shown the currently-selected shape **C**.

Select shape **C** to sew with DATA CHANGE key

. It is possible to select the shape from

among 12 shapes at the time of your purchase. However, it is possible to select the shape from among maximum 31 shapes by increasing the shape selection level (K004).

→ Refer to **"V-21. Method of changing memory switch data" p.63.**

4) Perform trial sewing.

Press READY key ㉑  to set the mode to the sewing mode. Then it is possible to perform sewing and the selected shape can be sewn.

* For the initial value pattern, only the needle thread tension and sewing speed can be edited. Be aware that, if the pattern shape is changed or the pattern is re-called, the edited data will return to the initial values.

5) Copy initial value pattern.

Copy the pattern which has been selected and confirmed through the steps above to the normal pattern and use it.

→ Copying procedure refer to **"V-13. Copying sewing pattern" p.49.**

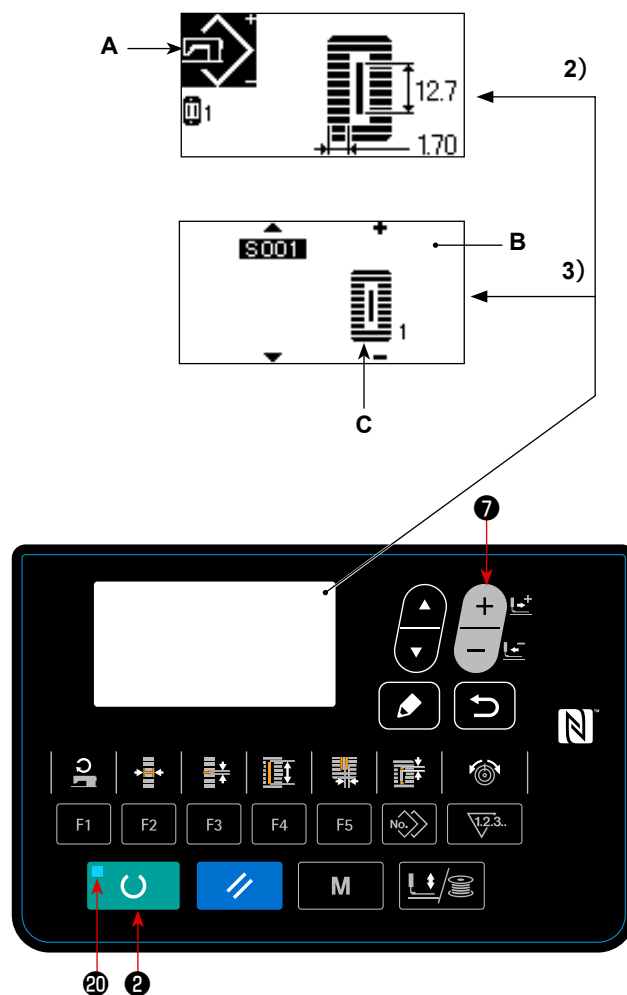

10. Changing sewing data

(1) Initial sewing data at the time of your purchase

Patterns from 1 to 10 have been already registered at the time of your purchase. Initial values of the square type, the cloth cutting length of which only is different from each other, have been inputted in the sewing data.

→ Refer to "**XI. INITIAL VALUE DATA FOR EACH SHAPE TABLE**" p.95.

Pattern No.	Cloth cutting length 	S002
1	6.4 mm (1/4")	
2	9.5 mm (3/8")	
3	11.1 mm (7/16")	
4	12.7 mm (1/2")	
5	14.3 mm (9/16")	
6	15.9 mm (5/8")	
7	17.5 mm (11/16")	
8	19.1 mm (3/4")	
9	22.2 mm (7/8")	
10	25.4 mm (1")	

(2) Changing procedure of sewing data

1) Set the mode to the input mode.

Under the input mode where SET READY LED  goes out, sewing-data change is enabled.

If the current mode is the sewing mode, press

READY key  to change over the mode to the input mode.

2) Call sewing data edit screen.

When EDIT key  is pressed, the sewing data edit screen **A** for the currently-selected pattern No. is displayed.

3) Select sewing data to be changed.

Press ITEM SELECT key , and select the data item you desire to change.

Data item which is not used according to the shape and data item which is set without function are skipped and not displayed. So, be careful.

→ Refer to "**V-11. Method of setting sewing data with/without edit**" p.42.

4) Change data.

For the sewing data, there are data item which changes numerical value and that which selects pictograph. No. such as **S002** is attached to the data item which changes numerical value. Increase or decrease the

set value with DATA CHANGE key  to change the value.

No. such as **S001** is attached to the data item which selects pictograph. Pictograph can be selected with

DATA CHANGE key .

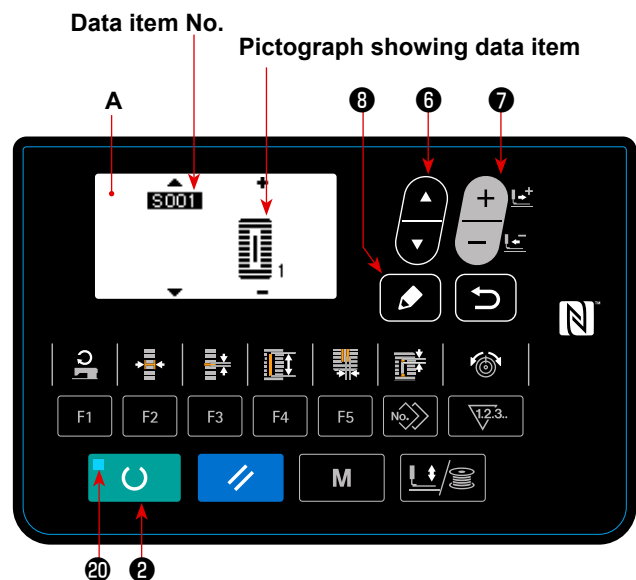

→ For the details of sewing data, refer to "**V-12. Sewing data list**" p.43.



5) Changing the name of pattern data.

Select "S500 Pattern data name" and press EDIT key ⑧  to enable change of the pattern data name.

When you press ITEM SELECT key ⑥ , the edit point will move in sequence. The character placed between "+" and "-" is the edit position under selection.

Press DATA CHANGE key ⑦  while the character is being selected, the character can be selected. Press RESET key ③  to delete the character which is being selected. When you keep RESET key ③  held pressed for one second, the data name can be deleted. Change the pattern data name by carrying out the aforementioned procedure in repetition.

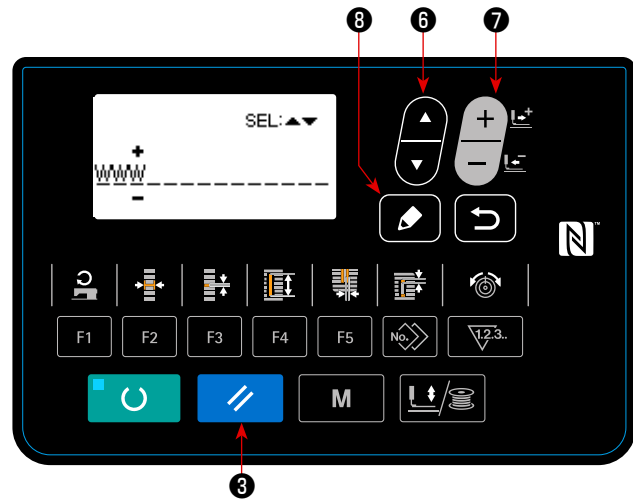

The characters that can be used for the pattern name

A - Z, 0 - 9, ., +, -, /, #, (blank)

11. Method of setting sewing data with/without edit

This sewing machine has been set so as not to be capable of editing sewing data items which are less frequently used at the time of your purchase. When you desire to set the data more closely in accordance with the sewing products, set the sewing data item to the edit possible state and use the machine.

* For the setting of sewing data with/without edit, when S052, right parallel section tension is set to without edit, sewing is performed with the data of S051 left parallel section tension. When S056, 2nd bar-tacking tension is set to without edit, sewing is performed with the data of S055, 1st bar-tacking section.

When the sewing data items other than the above ones are set to without edit, the data to be referred are the initial value data.

1) Set the mode to the input mode.

Under the input mode where SET READY LED  goes out, data setting is enabled.

If the current mode is the sewing mode, press

READY key  to change over the mode to the input mode.

2) Call sewing data with/without edit changeover screen.

Press MODE key . Select "05 Sewing parameter edit select". Then, data edit enable/disable changeover screens **A** and **B** are displayed.

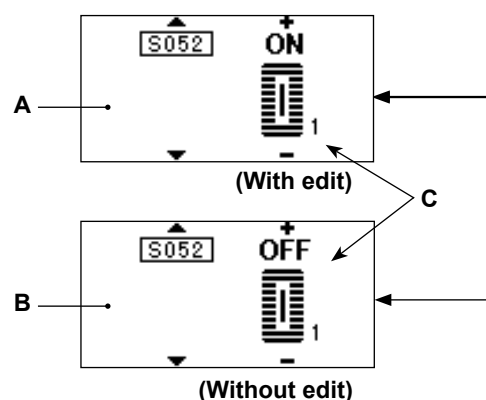

3) Select sewing data you desire to change over.

Press ITEM SELECT key , and select sewing data item **C** you desire to change over. At this time, changeover possible item only can be selected.

4) Changeover of with/without edit.



When DATA CHANGE key  is pressed, the pictograph display **C** for the currently-selected sewing data is changed over.

Non-reverse display : With edit

Reverse display : Without edit

Return to step 3), and plural sewing data items can be changed over.

5) Save data which have been set.



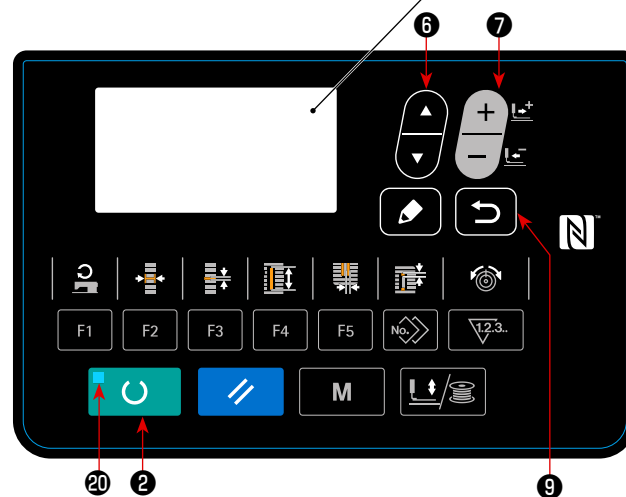









When RETURN key  is pressed, the changed-over state is saved and the screen returns to the mode screen. When RESET key  is pressed, the screen returns to the previous screen.



























12. Sewing data list

☆ Sewing data are those that can be inputted to 99 patterns from pattern 1 to 99 and can be inputted to each pattern. The sewing machine has been set in the state that the data which is necessary to set "With/without edit" cannot be selected at the time of your purchase. Change over the function to "With edit" if necessary for the use.

→ Refer to "**V-11. Method of setting sewing data with/without edit**" p.42.









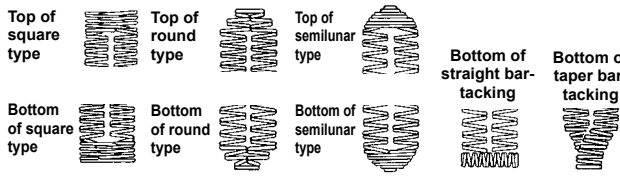

No.	Item	Setting range	Edit unit	Remarks
S001	<p>Sewing shape Select a desired pattern shape from among 31 sewing shapes stored in the sewing machine.</p>  <p>Refer to "II-2. Standard sewing shape list" p.3.</p> <p>* Only 12 kinds of standard sewing shapes can be selected at the time of your purchase. When increasing the kinds of shapes, perform setting of K004 Sewing shape selection level of memory switch data. → Refer to "V-22. Memory switch data list" p.64.</p>	1 to 31	1	–
S002	<p>Cloth cut length This item sets the length of cloth that is cut by cloth cutting knife. However, in case of bar-tack shape (Nos. 27, 28, 29, and 30 of S001), sewing length is set. By making effective U019 Function of plural motions of cloth cutting knife of memory switch data, make the plural motions of knife by the knife size set in the item U018 Cloth cutting knife size, and the sewing product is cut. → Refer to "V-22. Memory switch data list" p.64.</p> 	3.0 to 219.6	0.1 mm	–
S003	<p>Knife groove width, right This item sets the clearance between cloth cutting knife and right parallel section.</p> 	-2.00 to 2.00	0.05 mm	–
S004	<p>Knife groove width, left This item sets the clearance between cloth cutting knife and left parallel section.</p> 	-2.00 to 2.00	0.05 mm	–
S005	<p>Overedging width, left This item sets the overedging width of left parallel section.</p> 	0.10 to 5.00	0.05 mm	–
S006	<p>Ratio of right and left shapes This item sets enlargement/reduction ratio of right side shape making the knife position as the center.</p> 	50 to 150	1%	–
S007	<p>Pitch at parallel section This item sets sewing pitch of left and right parallel sections.</p> 	0.200 to 2.500	0.025 mm	–
S008	<p>2nd bar-tacking length This item sets length of bar-tacking on the front side.</p> <p>Bottom of square type  Bottom of straight bar-tacking  Bottom of taper </p> 	0.2 to 5.0	0.1 mm	–
S009	<p>1st bar-tacking length This item sets length of bar-tacking on the rear side.</p> <p>Top of square type </p> 	0.2 to 5.0	0.1 mm	–

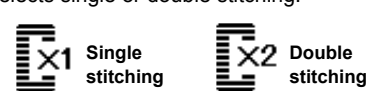
No.	Item	Setting range	Edit unit	Remarks
S010	<p>Compensation of bar-tacking width, right This item adjusts right side outer shape of bar-tacking section in terms of overedging section. It is corrected 1st and 2nd bar-tacking together.</p> <p>Top of square type  Bottom of square type  Bottom of straight bar-tacking </p> 	-1.00 to 1.00	0.05 mm	-
S011	<p>Compensation of bar-tacking width, left This item adjusts left side outer shape of bar-tacking section in terms of overedging section.</p> <p>Top of square type  Bottom of square type  Bottom of straight bar-tacking </p> 	-1.00 to 1.00	0.05 mm	-
S012	<p>Taper bar-tacking offset, left This item sets length to form bar-tacking section of taper bar-tacking shape.</p> 	0.00 to 3.00	0.05 mm	*1
S013	<p>Taper bar-tacking offset, right This item sets length to form bar-tacking section of taper bar-tacking shape.</p> 	0.00 to 3.00	0.05 mm	*1
S014	<p>Eyelet shape length This item sets upper side length from center of eyelet of eyelet shape.</p> 	1.0 to 10.0	0.1 mm	*1
S015	<p>Number of stitches of eyelet shape This item sets number of stitches in the upper 90° of eyelet shape.</p> 	1 to 8	1	*1
S016	<p>Eyelet width This item sets crosswise size of the inside of eyelet shape. Actual needle entry point is the dimension to which S004 Knife groove width, left is added.</p> 	1.0 to 10.0	0.1 mm	*1
S017	<p>Eyelet length This item sets lengthwise size of the inside of eyelet shape.</p> 	1.0 to 10.0	0.1 mm	*1
S018	<p>Round type shape length This item sets upper length from the center of round type shape.</p> <p>Top of round type  Top of Radial type  Top of semilunar type </p> <p>Bottom of round type  Bottom of radial type  Bottom of semilunar type </p> 	1.0 to 5.0	0.1 mm	*1
S019	<p>Number of stitches of radial shape This item sets number of stitches in the upper 90° of radial shape.</p> 	1 to 8	1	*1
S020	<p>Reinforcement of radial shape This item sets with/without reinforcement stitching of radial shape.</p> <p> : With  : Without</p>	-	-	*1, *2

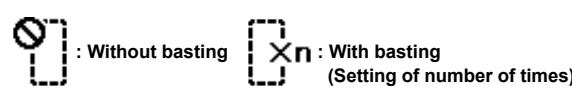
*1 : Displayed according to the shape

*2 : Displayed when it is set to with edit. Refer to "V-11. Method of setting sewing data with/without edit" p.42.

*3 : Displayed when the function is selected.

No.	Item	Setting range	Edit unit	Remarks
S021	<p>Pitch at bar-tacking section This item sets sewing pitch of bar-tacking section.</p> 	0.200 to 2.500	0.025 mm	–
S022	<p>1st clearance This item sets the clearance between 1st bar-tacking and knife groove. This item is applied to all shapes.</p> 	0.0 to 4.0	0.1 mm	–
S023	<p>2nd clearance This item sets the clearance between 2nd bar-tacking and knife groove. This item is applied to all shapes.</p> 	0.0 to 4.0	0.1 mm	–
S031	<p>Single/double stitching This item selects single or double stitching.</p> 	–	–	–
S032	<p>Double stitching cross selection This item selects overlapping stitching or cross stitching at the needle entry of parallel section when setting double stitching.</p> 	–	–	*3
S033	<p>Compensation of double stitching width This item sets amount to narrow overedging width of 1st cycle when setting double stitching.</p> 	0.0 to 2.0	0.1 mm	*3
S034	<p>Number of times of basting This item sets number of times of basting.</p> 	0 to 9	1 time	–
S035	<p>Basting pitch This item sets pitch at the time of performing basting.</p> 	1.0 to 5.0	0.1 mm	*3
S036	<p>Rolling length of basting This item sets rolling length of needle thread when performing basting.</p> 	2.0 to 20.0	0.1 mm	*3
S037	<p>Rolling pitch of basting This item sets rolling pitch of needle thread when performing basting.</p> 	0.2 to 5.0	0.1 mm	*3
S038	<p>Rolling width of basting This item sets rolling width of needle thread when performing basting.</p> 	0.0 to 4.0	0.1 mm	*3
S039	<p>Lengthwise compensation of needle entry of basting This item sets the amount to move needle entry position back and forth when performing basting more than two cycles.</p> 	0.0 to 2.5	0.1 mm	*2, *3

*1 : Displayed according to the shape

*2 : Displayed when it is set to with edit. Refer to "V-11. Method of setting sewing data with/without edit" p.42.















*3 : Displayed when the function is selected.

No.	Item	Setting range	Edit unit	Remarks
S040	Crosswise compensation of needle entry of basting This item sets the amount to move needle entry position to the right or left when performing basting more than two cycles.	0.0 to 1.0	0.1 mm	*3
S041	Compensation of left side position of basting This item sets the amount to move the sewing reference position of basting from the center of left overedging to the right or left.	-2.0 to 2.0	0.1 mm	*2, *3
S042	Compensation of right side position of basting This item sets the amount to move the sewing reference position of basting from the center of right overedging to the right or left.	-2.0 to 2.0	0.1 mm	*2, *3
S044	Speed setting of basting This item sets speed of basting.	400 to 4,200	100 sti/min	*3
S051	Left parallel section tension This item sets needle thread tension at left parallel section.	0 to 200	1	—
S052	Right parallel section tension This item sets needle thread tension at right parallel section.	0 to 200	1	*2
S053	Left parallel section tension (1st cycle of double stitching) This item sets needle thread tension at left parallel section of 1st cycle at the time of double stitching.	0 to 200	1	*2, *3
S054	Right parallel section tension (1st cycle of double stitching) This item sets needle thread tension at right parallel section of 1st cycle at the time of double stitching.	0 to 200	1	*2, *3
S055	Tension at 1st bar-tacking section This item sets needle thread tension at 1st bar-tacking section.	0 to 200	1	—
S056	Tension at 2nd bar-tacking section This item sets needle thread tension at 2nd bar-tacking section.	0 to 200	1	*2
S057	Setting of needle thread tension at the start of sewing This item sets needle thread tension of tie stitching at the start of sewing.	0 to 200	1	—
S058	Setting of needle thread tension of basting This item sets needle thread tension of basting.	0 to 200	1	*3
S059	ACT timing adjustment at the start of 1st bar-tacking This item adjusts needle thread tension output start timing at 1st bar-tacking section.	-5 to 5	1 stitch	*2

*1 : Displayed according to the shape

*2 : Displayed when it is set to with edit. Refer to "V-11. Method of setting sewing data with/without edit" p.42.







*3 : Displayed when the function is selected.

No.	Item	Setting range	Edit unit	Remarks
S060	ACT timing adjustment at the start of right overedging This item adjusts needle thread tension output start timing at right overedging section. 	-5 to 5	1 stitch	*2
S061	ACT timing adjustment at the start of 2nd bar-tacking This item adjusts needle thread tension output start timing at 2nd bar-tacking section. 	-5 to 5	1 stitch	*2
S062	Number of stitches of tie stitching at the start of sewing This item sets number of stitches of tie stitching at the start of sewing. 	0 to 8	1 stitch	-
S063	Sewing pitch of tie stitching at the start of sewing This item sets sewing pitch of tie stitching at the start of sewing. 	0.00 to 0.70	0.05 mm	*2
S064	Tie stitching width at the start of sewing This item sets tie stitching width at the start of sewing. 	0.0 to 3.0	0.1 mm	-
S065	Lengthwise compensation of tie stitching at the start of sewing This item sets start position of tie stitching in lengthwise direction at the start of sewing. 	0.0 to 5.0	0.1 mm	*2
S066	Crosswise compensation of tie stitching at the start of sewing This item sets start position of tie stitching in crosswise direction at the start of sewing. 	0.0 to 2.0	0.1 mm	*2
S067	Tie stitching width at the end of sewing This item sets tie stitching width at the end of sewing. 	0.1 to 1.5	0.1 mm	-
S068	Number of stitches of tie stitching at the end of sewing This item sets number of stitches of tie stitching at the end of sewing. 	0 to 8	1	-
S069	Lengthwise compensation of tie stitching at the end of sewing This item sets start position of tie stitching in lengthwise direction at the end of sewing. 	0.0 to 5.0	0.1 mm	*2
S070	Crosswise compensation of tie stitching at the end of sewing This item sets start position of tie stitching in crosswise direction at the end of sewing. 	0.0 to 3.0	0.1 mm	*2
S081	Knife motion This item sets "With/without motion" of normal cloth cutting knife.  : Normal knife motion OFF  : Normal knife motion ON	-	-	-
S083	Knife motion at 1st cycle of double stitching This item sets "With/without motion" of cloth cutting knife at 1st cycle when double stitching is performed.  : Normal knife motion OFF  : Normal knife motion ON	-	-	*2, *3

*1 : Displayed according to the shape

*2 : Displayed when it is set to with edit. Refer to "V-11. Method of setting sewing data with/without edit" p.42.

*3 : Displayed when the function is selected.

No.	Item	Setting range	Edit unit	Remarks
S084	<p>Maximum speed limitation</p> <p>This item sets max. speed limitation of the sewing machine. The maximum value of data edit is equal to the number of revolutions of K007 Maximum speed limitation of the memory switch data. → Refer to "V-22. Memory switch data list" p.64.</p> 	400 to 4,200	100 sti/min	–
S086	<p>Pitch of going</p> <p>This item sets sewing pitch of going side of bar-tacking shape (Shape Nos. 27, 28, 29 and 30 of S001).</p> 	0.200 to 2.500	0.025 mm	–
S087	<p>Width of going</p> <p>This item sets width of going side of bar-tacking shape (Shape Nos. 27, 28, 29 and 30 of S001).</p> 	0.1 to 10.0	0.05 mm	–
S088	<p>Pitch of coming</p> <p>This item sets sewing pitch of coming side of bar-tacking shape (Shape Nos. 27, 28, 29 and 30 of S001).</p> 	0.200 to 2.500	0.025 mm	–
S089	<p>Width of coming</p> <p>This item sets width of coming side of bar-tacking shape (Shape Nos. 27, 28, 29 and 30 of S001).</p> 	0.1 to 10.0	0.05 mm	–
S090	<p>Presser foot pressure</p> <p>Used to set the pressure to clamp the material. When the set value is 25, the presser foot pressure is approximately 4 kg. When the set value is 80, the presser foot pressure is approximately 10 kg.</p> 	20 to 80	1	–

13. Copying sewing pattern

Data of pattern No. which has been already registered can be copied to pattern No. which has not been used. Overwriting copy of the pattern is prohibited. When you desire to overwrite, perform it after erasing the pattern once.

1) Set the mode to input mode.

Under the input mode where SET READY LED ⑳ goes out, copy is enabled.

If the current mode is the sewing mode, press READY key ②  to change over the mode to the input mode.

2) Select pattern No. of copy source.

Press ITEM SELECT key ⑥  to select the source pattern No.

→ Refer to "[V-4. Performing pattern selection](#)" p.33.

When creating pattern data quite newly. it is convenient to copy the initial value pattern.



→ Refer to "[V-9. Using the initial value pattern](#)" p.39.

3) Call copy screen.

Press COPY key ⑲ , and copy screen A is displayed.

4) Select pattern No. of copy destination.

Pattern No. B which is not used is displayed.

Press DATA CHANGE key ⑦  to select a number to be used for copying. When you desire to erase the pattern, select the garbage can .

5) Start copying.

When READY key ②  is pressed, the copy starts. Then, the screen returns to the input screen on which the pattern No. which is created by copying is selected.

When RETURN key ⑨  is pressed, the screen returns to the previous screen without performing copying.

* In addition, cycle data and continuous stitching data can be copied by the same method.

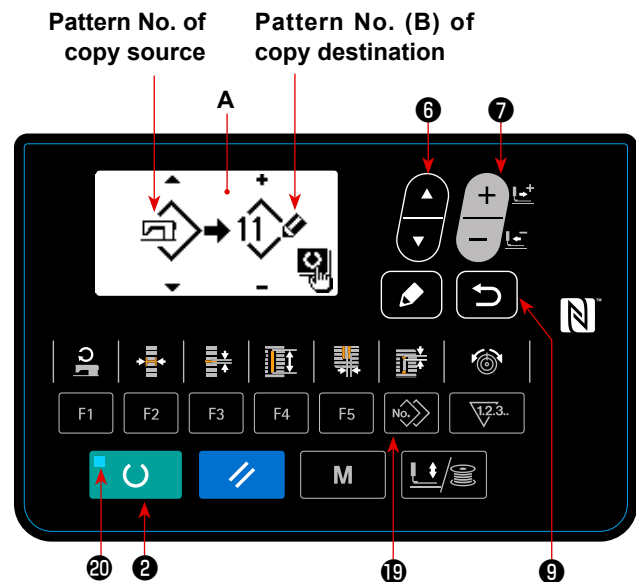

14. How to edit/check the data other than sewing data

The screen for editing/checking the various data is invoked by selecting the menu on the mode screen.

1) Set the mode to input mode.

Under the input mode where set ready LED ⑳ goes out, the mode screen can be called. If the current mode is the sewing mode, press READY key ②  to change over the mode to the input mode.

2) How to invoke the mode screen.

Press MODE key ④  to display the mode screen (operator level).

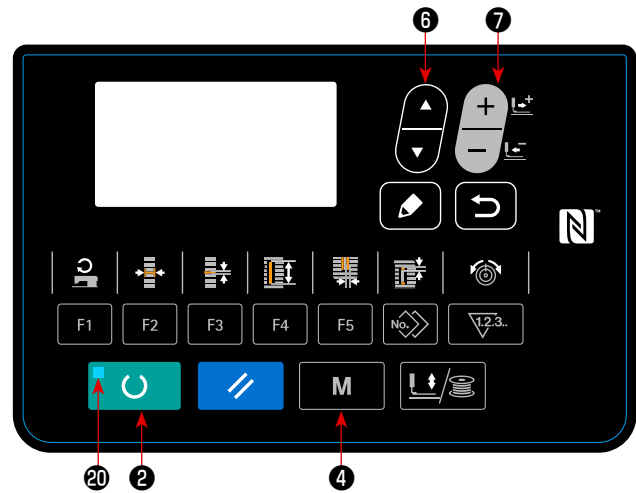

Then, keep MODE key ④  held pressed for three seconds to display the mode screen (service level).

On each level mode screen, the menu items listed in the table below are displayed.



Display level	Menu on the mode screen
Operator level	Memory switch 1 Version display Communication Regist. of parmtr key Sewing parameter edit selection
Maintenance personnel level	USB format Check program Pedal VR adjustment Adjustment of contrast Memory switch 2 Key lock

3) Selecting the menu.

Items which can be registered on the key are displayed. Press ITEM SELECT key  to select the target menu. When you press EDIT key  during the menu selection, the following screens can be invoked.

1. Memory switch 1

→ Refer to "[V-21. Method of changing memory switch data](#)" p.63 for details.

2. Version display

Version of the system software is displayed.

3. Communication

→ Refer to "[V-27. Communication](#)" p.71 for details.

4. Regist. of parameter key

→ Refer to "[V-15. Using parameter register key](#)" p.52 for details.

5. Sewing parameter edit selection

→ Refer to "[V-11. Method of setting sewing data with/without edit](#)" p.42 for details.

6. USB format

→ Refer to the Engineer's Manual for details.

7. Check program

→ Refer to the Engineer's Manual for details.

8. Pedal VR adjustment

→ Refer to "[V-24. How to adjust the pedal variable resistor](#)" p.69 for details.

9. Adjustment of contrast

→ Refer to "[V-25. How to adjust the contrast](#)" p.70 for details.

10. Memory switch 2

→ Refer to "[V-22. Memory switch data list](#)" p.64 for details.

11. Key lock

→ Refer to the Engineer's Manual for how to enable selection of the key lock from the mode screen and how to set the key lock.



For the functions which are not described in this manual, only the maintenance personnel is allowed to operate while referring to the Engineer's Manual since operating those functions can lock up the sewing machine or can cause unforeseen accidents.

15. Using parameter register key

Register parameters which are frequently used with parameter register key and use them.

Parameters which have been registered can be selected by pressing only the parameter register key under the input mode.

(1) Method of register

1) Set the mode to the input mode.

Under the input mode where SET READY LED 20 goes out, parameter registration is enabled.

If the current mode is the sewing mode, press

READY key 2  to change over the mode to the input mode.

2) Call parameter register screen.

Press MODE key 4  to display the mode screen. Select the parameter key registration on this screen. Then, the parameter registration screen A is displayed.

When you press EDIT key 8 , the parameter registration key setting screen is displayed.

The parameter registration key setting screen can also be displayed by keeping the parameter registration key you want to edit held pressed.

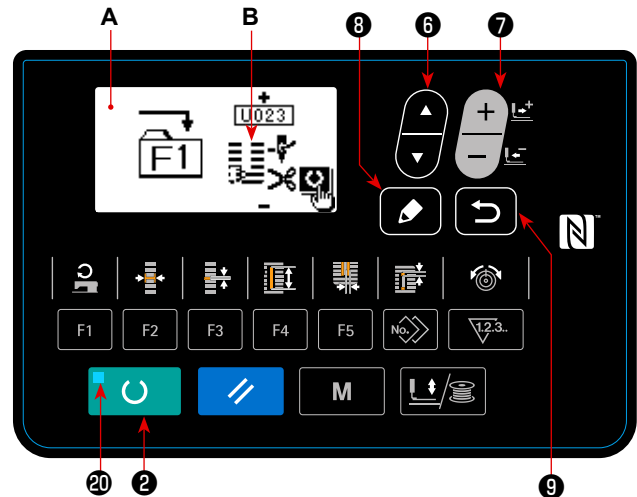



3) Select parameter.

Item B which can be registered to the key is displayed. Press ITEM SELECT key 6  to select the item to be registered.





Items which can be registered are sewing data, parameters of memory switches (level 1) and pattern Nos. In addition, when trash can  is selected, register can be released.

4) Start register.

When READY key 2  is pressed, registration starts, and the screen returns to the mode screen.

When RETURN key 9  is pressed, the screen returns to the previous screen without performing registration.

(2) Register status at the time of your purchase

Register key	Registered parameter
F1	Changeover of single/double stitching  S031
F2	Basting (off/number of times)  S034
F3	Basting needle thread tension setting  S058
F4	Plural motions of cloth cutting knife Ineffective/effective  U019
F5	Cloth cutting knife size  U018

16. Performing continuous stitching

This sewing machine can perform continuous stitching which is capable of continuously sewing plural sewing pattern data without lifting the presser foot. It is possible to automatically sew up to maximum 6 shapes in one cycle.

In addition, registration of as many as 20 data can be performed. Copy and use the data to fill the needs.

→ Refer to "[V-13. Copying sewing pattern](#)" p.49.

* It is necessary to change the parts from the state at that time of your purchase according to the setting conditions.

(1) Selection of continuous stitching data

1) Set the mode to the input mode.

Under the input mode where SET READY LED ⑳ goes out, the continuous-sewing data selection is enabled.

If the current mode is the sewing mode, press

READY key ②  to change over the mode to the input mode.

Only under the input mode, the continuous-sewing data selection is enabled.

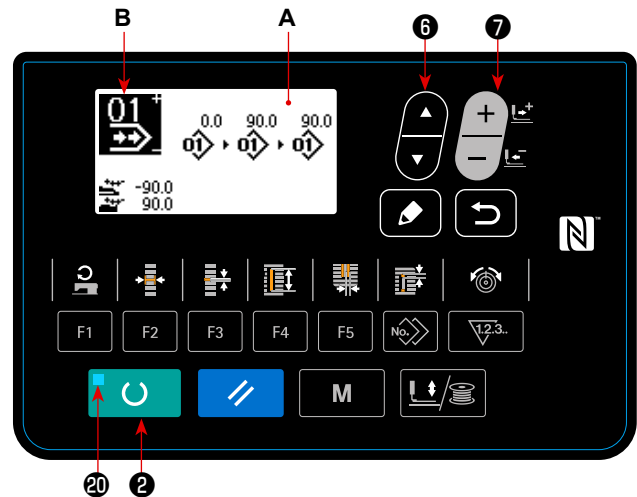

2) Select continuous stitching.

Press ITEM SELECT key ⑥  to select the continuous-sewing screen A.

Press DATA CHANGE key ⑦  to select the continuous-sewing data No. B to be sewn.

3) Perform sewing.

When READY key ②  is pressed in the state where the continuous-sewing data is selected, SET READY LED ⑳ lights up to show that the sewing is enabled.

Continuous stitching data No. 1 through No. 5 have been registered at the time of purchase.

(2) Method of editing continuous stitching data

1) Set the mode to the input mode.

Under the input mode where SET READY LED ⑳ goes out, entry of the continuous-sewing data is enabled.

If the current mode is the sewing mode, press READY key ②  to change over the mode to the input mode.

2) Set continuous stitching data to editing status.

When EDIT key ③  is pressed, the continuous-sewing data editing display C appears on the screen. The pattern No. D to be sewn is displayed in reverse video.

In this state, it is possible to edit the data.

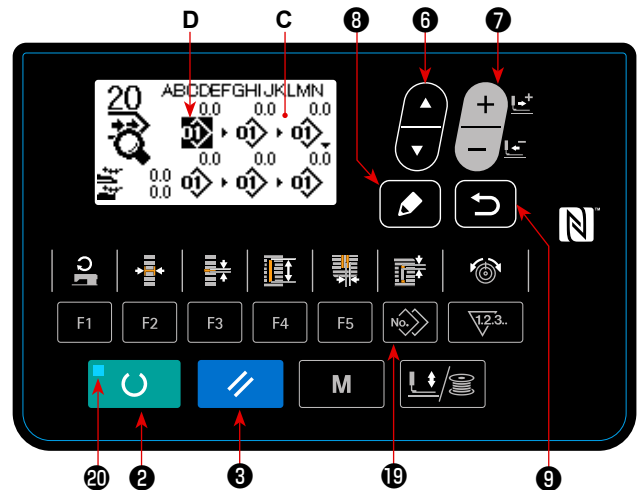

3) Select editing point.

When you press ITEM SELECT key ⑥ , the edit point will be changed in sequence and the currently-selected edit point is displayed in reverse video. When the edit point is carried to the last piece of data, the additional indication pictograph is displayed if there is an available pattern number. If you bring the edit point forward further, the data name will be the edit point.

● In the case the edit point is the pattern number

When copy key ⑱  is pressed, the additional command pictograph is displayed to enable insertion of pattern data.

● In the case the edit point is the data name

When EDIT key ③  is pressed, the name of the data can be edited.



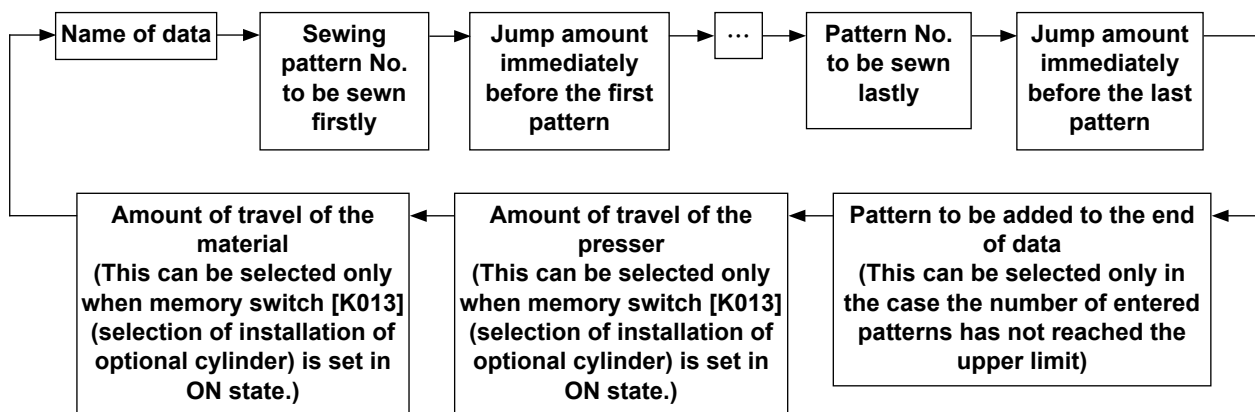

The selection sequence of edit points when the item select key is pressed





4) Change data of selected editing point.

When DATA CHANGE key **7**  or RESET key **3**  is pressed, the data at the edit point can be changed.

● When the editing point is at the pattern No. :

- In the case data change key **7**  is pressed:
Pattern No. which has been registered is displayed and it is possible to select.
- In the case RESET key **3**  is pressed:
The pattern data at the edit point can be deleted.
When RESET key **3**  is held pressed for one second, all the registered pattern data can be deleted.
- In the case EDIT key **8**  is pressed:
The pattern data at the edit point can be edited.
When the RETURN key **9**  is pressed, the operation step returns to editing of the previous continuous sewing data.

● In the case the edit point is located at the jump amount, the amount of travel of the presser foot or the amount of travel of the material:



- In the case DATA CHANGE key **7**  is pressed:
It is possible to edit numerical value within the range of ± 220 mm.
- In the case RESET key **3**  is pressed:
Set the numerical value of the edit point at 0 (zero).



In the case two or more pieces of pattern data have been registered, press COPY key **19**  with the edit point placed at the jump amount to respectively enter the following:

- The jump amount immediately before the 2nd pattern as the travel amount of the material;
- The jump amount added with a minus sign as the travel amount of the presser foot.

Repeat steps **3)** and **4)** to perform editing data.

5) Cancelling insertion of the pattern data.

While the additional command pictograph is displayed on the screen, the insertion of the pattern data can be cancelled by pressing RESET key ③ , READY key ②  or RETURN key ⑨ .

- When RESET key ③  is pressed, the insertion of the pattern data is cancelled.
- When READY key ②  is pressed, the insertion of the pattern data is cancelled and the operation mode is changed over to the sewing mode.
- When RETURN key ⑨  is pressed, the insertion of the pattern data is cancelled and the operation mode is changed over to the input mode.

* **Input is completed by the steps above. For the continuous stitching, however, input all data within the range of the presser size. Error message will be shown when the data exceeds the range. Be sure to precisely input the presser size.**

6) Creating new continuous stitching data

Press COPY key ⑬ , under the input mode, to call the copy screen. Then, press ITEM SELECT key



to select the new-creation pictograph. This enables the creation of new continuous-sewing data.

When you press DATA CHANGE key ⑦  while the new-creation pictograph is being selected, the pattern number to be newly created can be selected.

Then, select the pattern number to be newly created and press READY key ②  to create new continuous-sewing data.

17. Performing cycle stitching

This sewing machine can perform sewing of plural sewing pattern data in one cycle in the order of the data. As many as 30 different patterns can be entered. Use this function to sew two or more different buttonholes on sewing products.

In addition, registration of as many as 20 cycles can be performed. Copy and use the data to fill the needs.

→ Refer to "[V-13. Copying sewing pattern](#)" p.49.

(1) Selection of cycle data

1) Set the mode to the input mode.

Under the input mode where SET READY LED ⑳ goes out, selection of the cycle data is enabled.

If the current mode is the sewing mode, press

READY key ②  to change over the mode to the input mode.

Only under the input mode, selection of the cycle data is enabled.

2) Select cycle stitching data.

Press ITEM SELECT key ⑥ , and patterns

which have been registered are changed over and displayed in order. Cycle data No. and continuous stitching data No. which have been registered after the last registered pattern No. are displayed. Here, select the cycle data No. which you desire to sew.

3) Perform sewing.

When READY key ②  is pressed in the state where the cycle data is selected, SET READY LED ⑳ lights up to show that the sewing is enabled.

Cycle data No. 1 through No. 4 have been registered at the time of purchase.

It should be noted that when the power to the sewing machine is turned OFF while it is engaged in the sewing of cycle data, and is re-turned ON to re-start sewing of the same cycle data, the sewing machine will start sewing from the pattern data it has been sewing before the power is turned OFF.

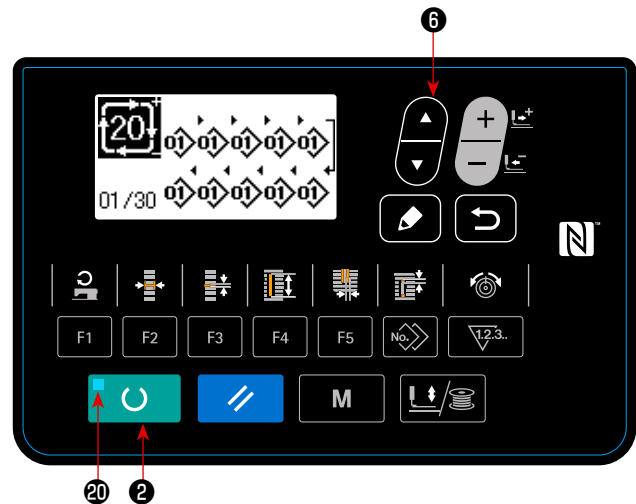

(2) Method of editing cycle data

1) Set the mode to input mode.

Under the input mode where SET READY LED ⑳ goes out, entry of the cycle data is enabled.

If the current mode is the sewing mode, press

READY key ②  to change over the mode to the input mode.

2) Set cycle data to editing status.

When EDIT key ③  is pressed, the cycle data editing display C appears on the screen. The pattern No. D to be sewn is displayed in reverse video.

In this state, it is possible to edit the data.

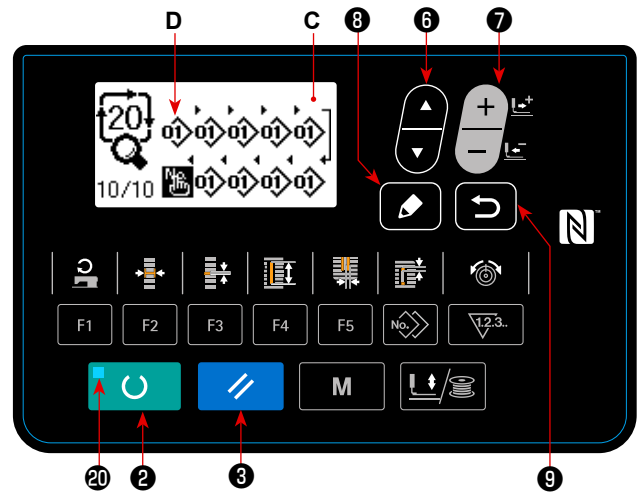

3) Select editing point.

When you press ITEM SELECT key ④ , the edit point will be changed in sequence and the currently-selected edit point is displayed in reverse video. When the edit point is carried to the last piece of data, the additional indication pictograph is displayed if there is an available pattern number. If you bring the edit point forward further, the data name will be the edit point.

● In the case the edit point is the pattern number

When COPY key ⑤  is pressed, the additional command pictograph is displayed to enable insertion of pattern data.

● In the case the edit point is the data name

When EDIT key ③  is pressed, the name of the data can be edited.

The selection sequence of edit points when the item select key is pressed

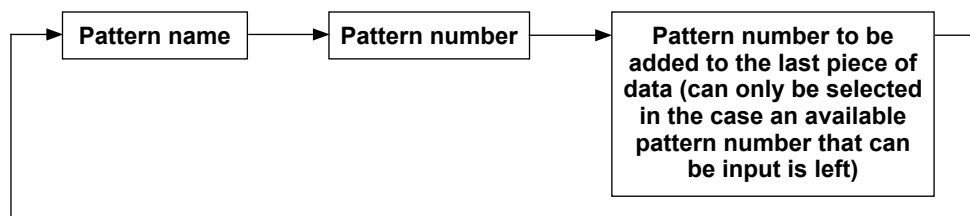



4) Change data of selected editing point.

Press DATA CHANGE key ⑦  and data of editing point can be changed.

Pattern No. which has been registered is displayed and it is possible to select.

In addition, press RESET key ③ , and the pattern data of editing point can be deleted.

When RESET key ③  is held pressed for one second, all the registered pattern data can be deleted.

When EDIT key ⑧  is pressed, the pattern data at the edit point can be edited.

When RETURN key ⑨  is pressed, the operation step returns to the editing of the previous cycle data.

Repeat steps 3) and 4) to perform editing data.

5) Cancelling insertion of the pattern data.

When RESET key ③  is pressed while the addition command pictograph is displayed, insertion of the pattern data can be cancelled.

In addition, when READY key ②  is pressed, insertion of the pattern data is cancelled and the mode changes over to the sewing mode.

When RETURN key ⑨  is pressed, insertion of the pattern data is cancelled and the mode changes over to the input mode.

6) Creating new cycle data

Press COPY key ⑩ , under the input mode, to call the copy screen. Then, press ITEM SELECT key

⑥  to select the new-creation pictograph. This enables the creation of new cycle data.

When you press DATA CHANGE key ⑦  while the new-creation pictograph is being selected, the pattern number to be newly created can be selected.

Then, select the pattern number to be newly created and press READY key ②  to create new cycle data.

18. How to change the name of cycle/continuous sewing data

1) Putting the data name in the edit state.

Refer to "[V-16. Performing continuous stitching](#)" p.53 and "[V-17. Performing cycle stitching](#)" p.57.

2) Changing the name of data.

Refer to "[V-10. Changing sewing data](#)" p.40.

19. Explanation of the service patterns

The LBH-1796A has been factory-installed with four cycle sewing patterns; six-buttonhole sewing patterns (for ladies' wear and men's wear) and five-buttonhole sewing patterns (for ladies' wear and men's wear) as service patterns.

In the shipped state, the installation of optional material presser cylinder has been factory-placed in OFF state. When K013 (selection of installation of optional cylinder) is set in ON state, the material carrying operation after the completion of sewing of a continuous sewing pattern is enabled.

In this chapter, the operation of the service patterns in the case the selection of installation of optional cylinder is placed in ON state is explained.

Description of the service patterns

* Direction of feed + : The feed moves to the left (forward direction).

- : The feed moves to the right (backward direction).

Cycle No.	Description	Panel display	Description of settings of continuous sewing	Material feed amount
1	Six-buttonhole sewing for ladies' wear		Continuous sewing No.1 	Feed with the presser foot brought to its upper position : -90.0 mm Feed with the presser foot brought to its lower position : 90.0 mm
2	Six-buttonhole sewing for men's wear		Continuous sewing No.2 	Feed with the presser foot brought to its upper position : 90.0 mm Feed with the presser foot brought to its lower position : -90.0 mm
3	Five-buttonhole sewing for ladies' wear		Continuous sewing No.1 Continuous sewing No.3 	Feed with the presser foot brought to its upper position : -90.0 mm Feed with the presser foot brought to its lower position : 90.0 mm

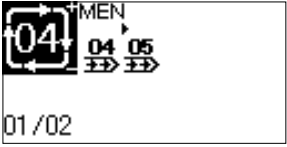
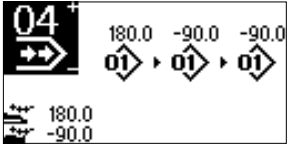
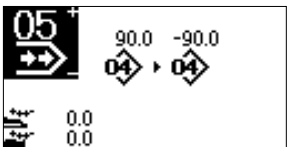
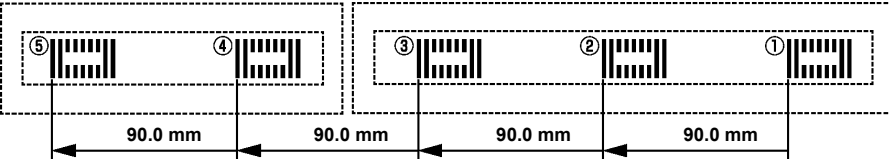
Cycle No.	Description	Panel display	Description of settings of continuous sewing	Material feed amount
4	Five-buttonhole sewing for men's wear		Continuous sewing No.4  Continuous sewing No.5 	Feed with the presser foot brought to its upper position : 90.0 mm Feed with the presser foot brought to its lower position : -90.0 mm
				

When sewing is carried out using the cycle sewing pattern No. 1, the operation sequence is as illustrated below. The sewing machine carries out sewing of ① to ⑥ in the written order. Between cycle steps 1 and 2, the material feed mechanism feeds the material by 90.0 mm.

Cycle step 1

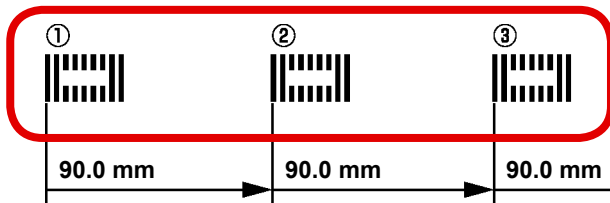

Cycle step 2

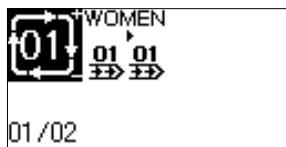
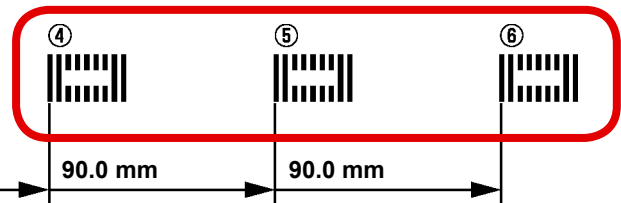

Cycle step 1 is the six-buttonhole sewing pattern for ladies' wear. Continuous sewing pattern No. 1 is set for both steps 1 and 2 of the cycle No. 1.

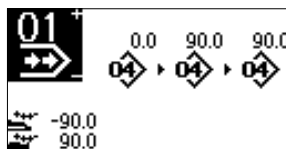

For continuous sewing No. 1, three steps of individual sewing pattern No. 1 are set at intervals of 90.0 mm. In addition, the material feed amount after the completion of sewing is set at 90.0 mm.

 For the initial setting, the material feed mechanism does not operate at the last step of cycle sewing. If it is necessary to operate the material feed mechanism, set K026 accordingly.

20. Explanation of plural motions of knife



This sewing machine can automatically actuate the knife plural times and sew a buttonhole larger than the size of knife by setting the size of knife attached from the operation panel. Set and use this function when sewing various sewing shapes without replacing the knife.

(1) Setting of plural motions of knife

1) Set the mode to the input mode.

Under the input mode where SET READY LED ⑳ goes out, edit of the memory switch is enabled. If the current mode is the sewing mode, press READY key ②  to change over the mode to the input mode.

2) Input the size of cloth cutting knife.

Press MODE key ④  to display memory switch data (level 1) edit screen A. Press ITEM SELECT key ⑥  to call U018 Cloth cutting knife size B. Then set size C of knife attached with DATA CHANGE key ⑦ .

→ For the details, refer to "V-22. Memory switch data list" p.64.

3) Set the function of the plural motions of cloth cutting knife to effective.

Next, press again ITEM SELECT key ⑥  to call U019 Function of the plural motions of cloth cutting knife D. Then set the plural motions of cloth cutting knife to the effective status with

DATA CHANGE key ⑦ .

→ For the details, refer to "V-22. Memory switch data list" p.64.

4) Perform sewing.

When READY key ②  is pressed, the sewing is enabled.

At this time, when S002 Cloth cutting length is set to a size larger than U018 Cloth cutting knife size which has been set above, the plural motions of knife is automatically performed for sewing.

* If a buttonhole smaller than the size of knife attached is desired to be sewn, error 489 will be displayed.

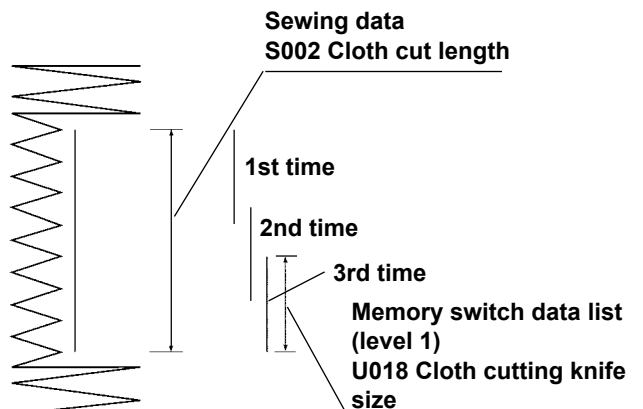
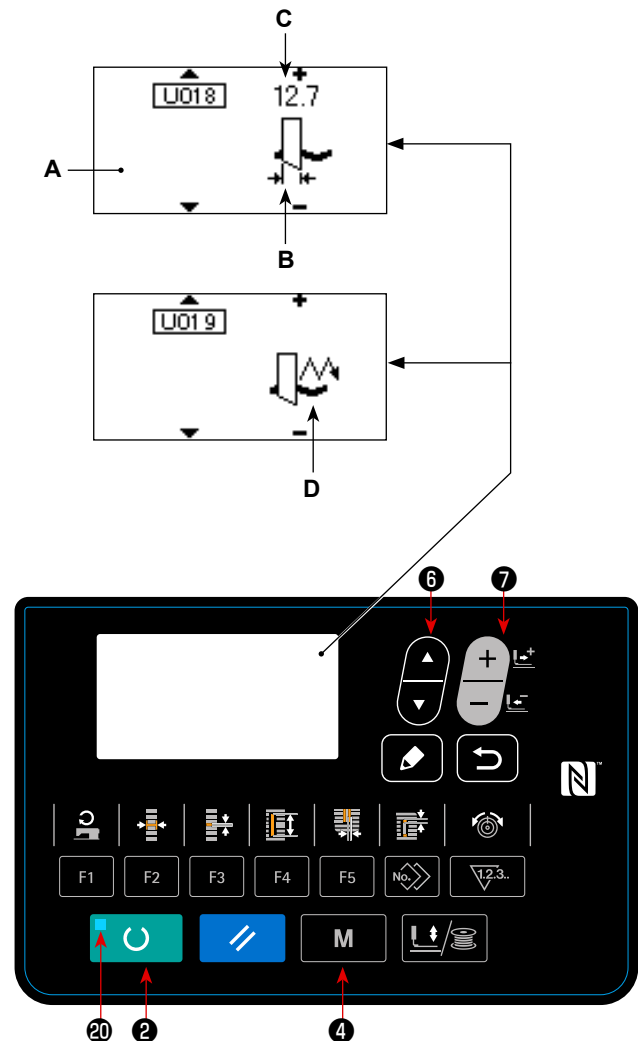

21. Method of changing memory switch data

1) Set the mode to input mode.

Under the input mode where SET READY LED ②⑩ goes out, change to the memory switch data is enabled.

If the current mode is the sewing mode, press READY key ②  to change over the mode to the input mode.

2) Call memory switch data edit screen.

When MODE key ④  is pressed, the mode screen (operator level) is displayed. On this screen, select the memory switch data (level 1).

When MODE key ④  is held pressed for three seconds, the mode screen (maintenance personnel level) is displayed. On this screen, the memory switch data (level 2) can be selected.

3) Select memory switch data to change.

Press ITEM SELECT key ⑥  and select the data item which you desire to change.

4) Change data.

There are one data item to change the numerical value and the other data item to select the pictograph in the memory switch data.

No. such as U001 is attached to the data item to change the numerical value. Set value can be changed by increasing/decreasing the value with DATA CHANGE key ⑦ .

No. such as K001 is attached to the data item to select the pictograph. Pictograph can be selected with DATA CHANGE key ⑦ .



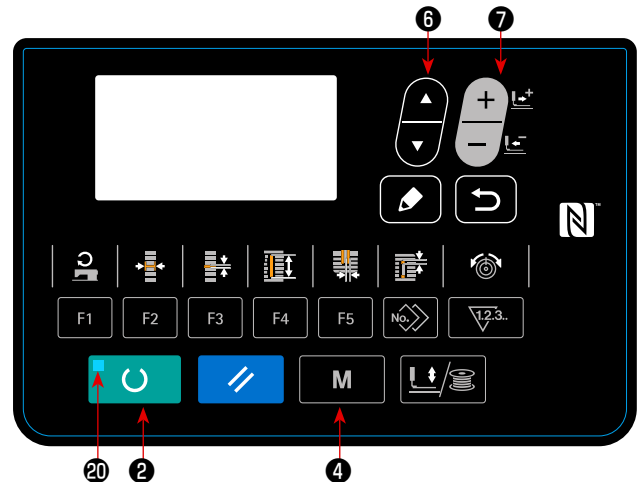











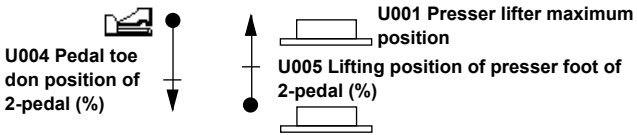



→ For the details of memory switch data, refer to "[V-22. Memory switch data list](#)" p.64.





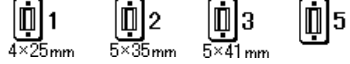











22. Memory switch data list

(1) Level 1









☆ Memory switch data (level 1) are the motion data that the sewing machine has in common and the data that operate on all sewing patterns in common.



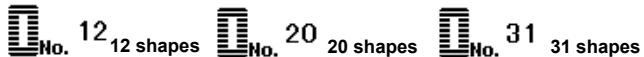
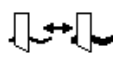



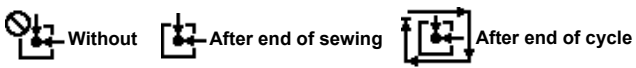
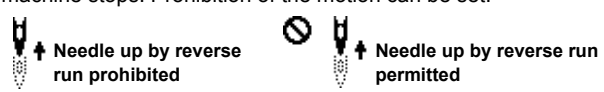











No.	Item	Setting range	Edit unit	Initial value	
U001	Presser lifter maximum position Height of maximum position of pedal operation is set.	 MAX	0 to 17.0	0.1 mm	6.0 mm
U002	Presser lifter intermediate position Height of intermediate position of pedal operation is set.		0 to 14.0	0.1 mm	6.0 mm
U003	Presser lifter cloth setting position Height of cloth setting position of pedal operation is set.		0 to 14.0	0.1 mm	0.0 mm
U004	Pedal toe down position of 2-pedal (%) Operation feeling at the time of 2-pedal is set. Refer to the item below.		5 to 95	1%	80%
U005	Lifting position of presser foot of 2-pedal (%) Operation feeling at the time of 2-pedal is set. Pedal toe down amount Presser lifting amount  U004 Pedal toe down position of 2-pedal (%) U005 Lifting position of presser foot of 2-pedal (%) U001 Presser lifter maximum position		5 to 95	1%	50%
U006	Needle thread tension at sewing end setting		0 to 200	1	35
U007	Needle thread tension at thread trimming setting		0 to 200	1	35
U008	Needle thread tension of basting for sewing together setting		0 to 200	1	60
U009	Soft-start speed setting 1st stitch		400 to 4,200	100 sti/min	800 sti/min
U010	Soft-start speed setting 2nd stitch		400 to 4,200	100 sti/min	800 sti/min
U011	Soft-start speed setting 3rd stitch		400 to 4,200	100 sti/min	2,000 sti/min
U012	Soft-start speed setting 4th stitch		400 to 4,200	100 sti/min	3,000 sti/min
U013	Soft-start speed setting 5th stitch		400 to 4,200	100 sti/min	4,000 sti/min
U014	Kind of presser Set the kind of the presser.  1 2 3 5 4×25mm 5×35mm 5×41mm	—	—	—	Type 5
U015	Presser size width When type 5 of U014 Kind of presser is set, input the width of the presser.		3.0 to 10.0	0.1 mm	4.0 mm
U016	Presser size length When type 5 of U014 Kind of presser is set, input the length of the presser.		10.0 to 220.0	0.5 mm	220.0 mm
U017	Sewing start position (Feed direction) Sewing start position in terms of presser is set. Set this item when starting position is desired to be shifted due to overlapped section or the like.		2.5 to 110.0	0.1 mm	2.5 mm

No.	Item	Setting range	Edit unit	Initial value
U018	Cloth cutting knife size Input knife size used. 	3.0 to 25.4	0.1 mm	25.4 mm
U019	Function of plural motions of cloth cutting knife Ineffective/effective  Ineffective  Effective	–	–	Ineffective
U020	Function of thread breakage detection Ineffective/effective  Ineffective  Effective	–	–	Effective
U021	Selection of presser position at the time of ON of READY key (Up/Down) Presser foot position when READY key is pressed is set.  Presser up  Presser down	–	–	Presser Up
U022	Selection of the position of presser foot at the time of the end of sewing (Up/Down) This item sets the position of presser foot at the time of the end of sewing. (Effective only at the time of 1-pedal setting)  Presser up  Presser down	–	–	Presser Up
U023	Needle thread trimming motion start distance Distance from the start of sewing to the start of needle thread trimmer release motion is inputted. 	0 to 15.0	0.1 mm	1.0 mm
U024	Bobbin thread trimming motion start distance Distance from the start of sewing to the start of bobbin thread trimmer release motion is inputted. 	0 to 15.0	0.1 mm	1.5 mm
U025	Counter updating unit Unit to update sewing counter is set. 	1 to 30	1	1
U026	Total number of stitches Non-display/Display  Non-display  Display	–	–	Non-display
U027	LED light luminance setting 	0 to 5	1	5
U500	Language choice The language to be used for the display on the sewing panel is selected. * The number of selectable languages differs depending on the specifications of the sewing machine at the time of shipment.	–	–	Not yet selected

(2) Level 2

☆ Press MODE switch for as long as three seconds and it is possible to edit.

No.	Item	Setting range	Edit unit	Initial value
K001	Pedal selection Pedal type is set. → Refer to "V-3. How to use the pedal" p.30.  2-pedal 1-pedal (Without intermediate position) 1-pedal (With intermediate position) 1-pedal (With a depress on the back part of the pedal)	–	–	1-pedal (Without intermediate position)
K003	Function of prohibition of selection of kind of presser Permitted/Prohibited Prohibition of change of U014 Kind of presser is set. 	–	–	Change prohibited
K004	Sewing shape selection level Number of sewing shapes which can be sewn can be increased. (Max. 31 shapes) 	–	–	12 shapes
K005	Cloth cutting knife power Output power of cloth cutting knife is set. 0 : Min. power → 3 : Max. power 	0 to 3	1	3
K006	Selection of machine type Type of sewing machine head is set. 0 : Standard type 1 : Dry head type 	0 to 1	1	0 (Standard type)
K007	Max. speed limitation speed setting Max. speed of sewing machine can be limited. When K006 Selection of machine type is set to dry head type, max. speed is automatically limited to 3,300 sti/min. 	400 to 4,200	100 sti/min	3,600 sti/min
K008	Compensation of unsteady needle thread tension Output value of needle thread tension is wholly offset and compensated. 	-30 to 30	1	0
K009	Output time of needle thread tension changed value When data related to needle thread tension is changed, the changed value is output as long as the set-up time. 	0 to 20	1s	0s
K010	Function of origin retrieval each time Origin retrieval is performed after completion of sewing or completion of cycle. 	–	–	Without
K011	Needle up by reverse run Permitted/Prohibited When U001 Presser lifter maximum position is set to 14.0 mm or more, motion of needle up by reverse run is automatically performed and the machine stops. Prohibition of the motion can be set. 	–	–	Permitted
K012	Feed speed setting This item sets for setting the jump speed. 	–	–	High speed

No.	Item	Setting range	Edit unit	Initial value
K013	Selection of installation of optional cylinder This item sets for selecting installation of the optional material presser cylinder.  OFF is selected  ON is selected	–	–	OFF is selected
K014	Selection of operation of the parallel lifting of the presser foot  OFF is selected  ON is selected	–	–	ON is selected
K018	Pattern selection function under sewing mode Ineffective/effective  Ineffective  Effective	–	–	Ineffective
K019	Thread trimming on the way in continuous stitching Permitted/Prohibited  Permitted  Prohibited	–	–	Permitted
K021	Release amount of bobbin thread trimmer at the start of sewing This item sets the amount of releasing the bobbin thread trimmer at the start of sewing. 	0 to 15	1 pulse	8
K022	Presser lifter speed This item sets presser lifter speed. 	1 to 3	–	3
K023	Work clamp error detecting position E083 The height at which the work clamp height error is detected is set. * If it is set at zero (0), the error will not be detected. 	0 to 10.0	0.1	7.5
K026	Selection of operation of the material feed mechanism at the final step of cycle sewing  OFF is selected  ON is selected	–	–	OFF is selected
K028	Setting of the holding power of Y-feed motor  Low  Medium  High	–	–	Low
K050	Selection of automatic lifting of cylinder at the end of indexer operation  With automatic lifting  Without automatic lifting	–	–	Without automatic lifting
K051 *1	Amount of correction of the lift of the presser foot at the time of parallel lifting This item sets for correcting the amount of lift of the presser foot at the time of parallel lifting. 	1.0 to 10.0	0.1	3.0

***1: In the case of parallel lifting of the work clamp foot, the amount of lift of the work clamp foot differs with the sewing starting point, i.e., between the case where the sewing starting point is on the left of the work clamp frame and the case where it is on the right of the frame.**

If the amount of lift of the work clamp foot is inadequate, change the setting of K051.

If the amount of lift of the work clamp foot exceeds 6.0 mm, the work clamp foot can interfere with the needle thread trimming scissors. Check the amount of lift of the work clamp foot before starting sewing.

23. How to change the sewing speed while the sewing machine is engaged in sewing

It is possible to change the sewing speed under the sewing mode.

1) Putting the sewing machine in the sewing mode.

When READY key **2**  is pressed in the state where the pattern data is selected, READY LED **20** lights up to enable sewing.



2) Displaying the sewing speed change screen.

When SEWING SPEED key **10**  is pressed, the sewing speed change screen **A** is displayed.

3) Changing the sewing speed.

The sewing speed can be changed in increments of 100 sti/min by pressing DATA CHANGE key **7**



The sewing speed can be maximized by pressing ITEM SELECT key **6**  and can be minimized (to 400 sti/min) by pressing ITEM SELECT key **6** .

The maximum sewing speed will be either the speed set for the pattern data with "S084 Maximum speed limitation" or with "K007 Maximum restricted-speed setting", whichever the lower.

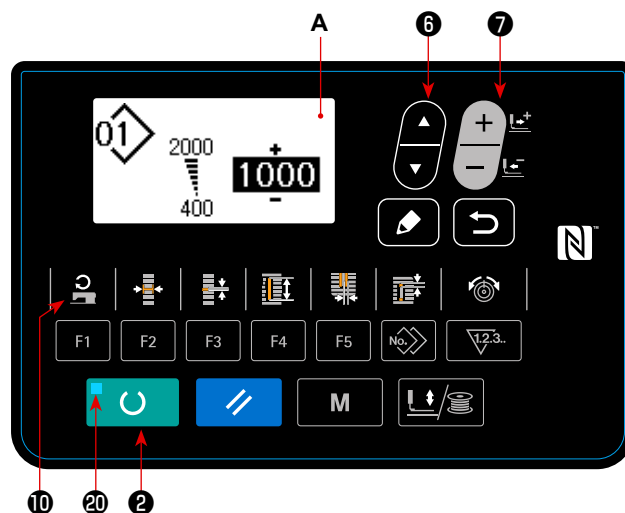

1. The sewing speed that can be changed on the sewing speed change screen is the actual sewing speed to be employed during sewing. To change the maximum sewing speed set for the pattern data with "S084 Maximum speed limitation", put the machine in the input mode and refer to "[V-10. Changing sewing data](#)" p.40.
2. Once the sewing speed is changed, the sewing speed for all pattern data is also changed. Even after the power is turned OFF, the changed sewing speed will remain in the memory.

24. How to adjust the pedal variable resistor

The variable resistor of the pedal can be adjusted by depressing the pedal or inputting a pedal variable resistor value on the operation panel.

1) Calling the pedal variable resistor adjustment screen.

Select the pedal variable resistor adjustment from the menu shown on the mode screen and press EDIT key **8**  to display the pedal variable resistor adjustment screen **A**.

2) Selecting the destination of registration of the pedal variable resistor value.





When ITEM SELECT key **6**  is pressed, the destination of registration of the current pedal variable resistor value is changed and displayed in reverse video successively. . Select the target destination of registration. The destination can be selected from the five ones shown in the table at the right.

3) Registering the pedal variable resistor value.

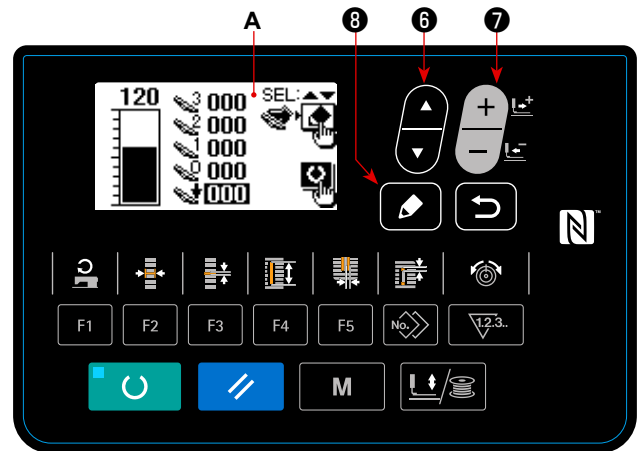
Press EDIT key **8**  to register and display the pedal variable resistor value on the selected destination of registration.

When you press DATA CHANGE key **7**  during the selection of the registered pedal variable resistor value, you can modify the value. The modifiable range of the pedal variable resistor value is from 0 to 255.



Display	Status of pedal to be registered
	Pedal is fully depressed
	Pedal is depressed to the neutral position
	Pedal is lightly depressed
	Pedal is not depressed
	Back part of the pedal is depressed

25. How to adjust the contrast

The contrast of the display on the panel can be adjusted in five steps.

1) Calling the contrast adjustment screen.

Select the contrast adjustment from the menu on the mode screen and press EDIT key **8** . Then, the contrast adjustment screen **A** is displayed.

2) Adjusting the contrast.

The contrast can be adjusted in five steps from 0 (brightest) to 4 (darkest) by pressing DATA

CHANGE key **7** .

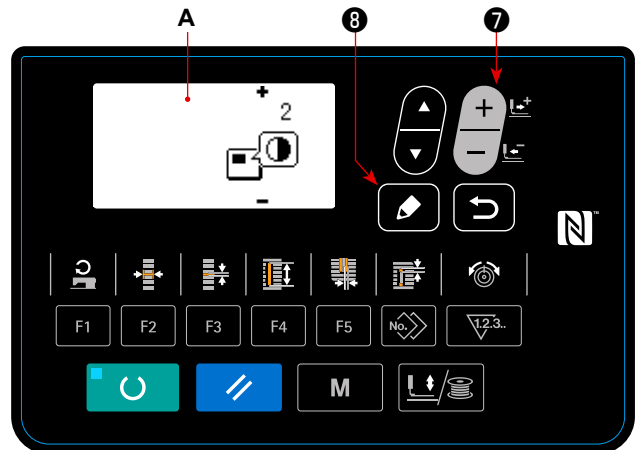

26. How to set the key lock

Operation of the data change key can be disabled by setting the key lock.

Refer to the Engineer's Manual for how to invoke the key lock setting function and how to set the key lock.

27. Communication

This sewing machine is capable of inputting/outputting data by means of an USB thumb drive.



1) Entering the communication mode.

Referring to the mode screen in "V-14. How to edit/check the data other than sewing data" p.50, select the communication mode.

2) Selecting the type of communication.

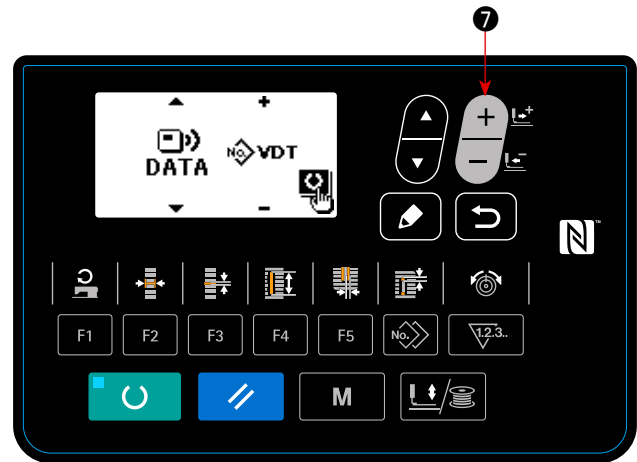
Press DATA CHANGE key  to select the type of communication.



Name of data		Extension	Description of data
Parameter data		LBH00 XXX . EPD	Unique LBH sewing data form such as stitch shape, cloth trimming length and overedging width created with the sewing machine.
Vector form data		VD00 XXX .VDT	Data on needle entry points created with the PM-1. The data form is commonly used among JUKI sewing machine.

* Refer to the Engineer's Manual for how to set the vector form data.





In the case the vector-format data is taken out from the operation panel and saved in a USB thumb drive or a tablet, and again returned to the operation panel, the set values of scale, sewing speed, etc. will be returned to their reference values. It is therefore necessary to check the set values before starting sewing. In addition, if multiple pieces of vector-format data are used for continuous sewing or cycle sewing, those data cannot be read with a tablet.

3) Selecting the communication direction.

Press ITEM SELECT key **6**  to display pictograph **A** which shows the communication direction selection.

Press DATA CHANGE key **7**  to select the communication direction.

 : Data shown on the operation panel is written on the USB thumb drive.

 : Data stored on the USB thumb drive is read into the operation panel.

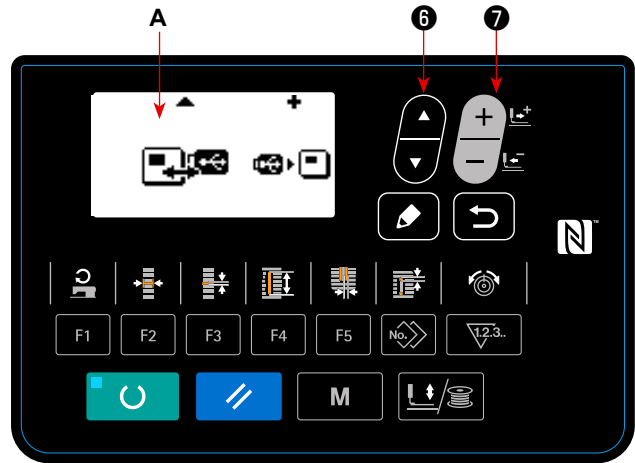

4) Selecting the number.

Press ITEM SELECT key **6**  to select file No. **B** to be read.

Press DATA CHANGE key **7**  to select file No. **C** to be written.

Press READY key **2**  to write the data in file No. **C**.

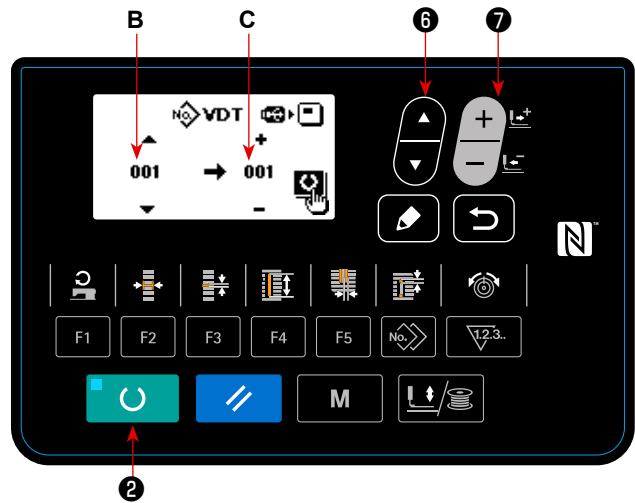

■ USB thumb drive

① Precautions to be taken when handling USB devices

- Do not leave the USB device or USB cable connected to the USB port while the sewing machine is in operation. The machine vibration can damage the port section resulting in loss of data stored on the USB device or breakage of the USB device or sewing machine.
- Do not insert/remove a USB device during reading/writing a program or sewing data. It may cause data breakage or malfunction.
- When the storage space of a USB device is partitioned, only one partition is accessible.
- Some type of the USB device may not be properly recognized by this sewing machine.
- JUKI does not compensate for loss of data stored on the USB device caused by using it with this sewing machine.
- When the panel displays the communication screen or pattern data list, the USB drive is not recognized even if you insert a medium into the slot.
- For USB devices and media such as CF(TM) cards, only one device/medium should be basically connected/inserted to/into the sewing machine. When two or more devices/media are connected/inserted, the machine will only recognize one of them. Refer to the USB specifications.
- Insert the USB connector into the USB terminal on the panel until it will go no further.
- Do not turn the power OFF while the data on the USB flash drive is being accessed.

② USB specifications

- Conform to USB 1.1 standard
- Applicable devices *1 _____ Storage devices such as USB memory, USB hub, FDD and card reader
- Not-applicable devices _____ CD drive, DVD drive, MO drive, tape drive, etc.
- Format supported _____ FD (floppy disk) FAT 12
Others (USB memory, etc.), FAT 12, FAT 16, FAT 32
- Applicable medium size _____ FD (floppy disk) 1.44MB, 720kB
Others (USB memory, etc.), 4.1MB ~ (2TB)
- Recognition of drives _____ For external devices such as a USB device, the device which is recognized first is accessed. However, when a medium is connected to the built-in media slot, the access to that medium will be given the highest priority. (Example: If a medium is inserted into the media slot even when the USB memory has already been connected to the USB port, the medium will be accessed.)
- Restriction on connection _____ Max. 10 devices (When the number of storage devices connected to the sewing machine has exceeded the maximum number, the 11th storage device and beyond will not be recognized unless they are once disconnected and re-connected.)
- Consumption current _____ The rated consumption current of the applicable USB devices is 500 mA at the maximum.

*1 : JUKI does not guarantee operation of all applicable devices. Some device may not operate due to a compatibility problem.

■ NFC

The operation panel supports NFC (Near Field Communication).

Sewing data, maintenance information or the like can be viewed, edited, copied, etc., on an Android terminal (such as tablet and smartphone) on which JUKI application for Android "JUKI Smart App" has been installed, by means of the NFC communication function.

Refer to the Instruction Manual for JUKI Smart App for details of JUKI application for Android "JUKI Smart App".

① Position of the NFC antenna

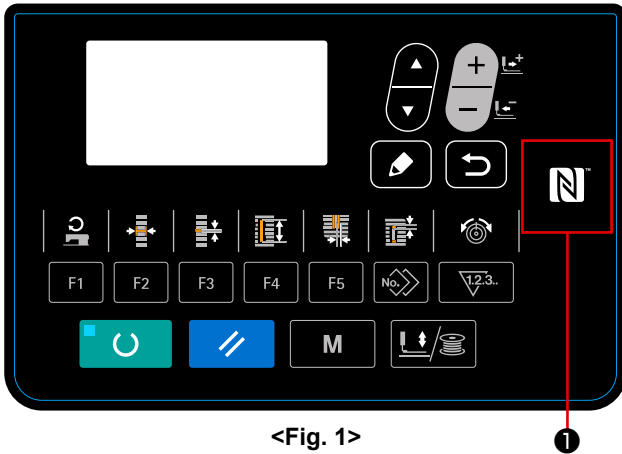

<Fig. 1>

[Position of the NFC antenna]

In the case of carrying out the NFC communication between the sewing machine and a tablet or smartphone, bring the antenna of the tablet or smartphone near to NFC mark ❶ as shown in Fig. 2.

* If the NFC communication has failed, error message will be displayed on the tablet/ smartphone screen.

When the error message is displayed on the screen, carry out the NFC communication again.

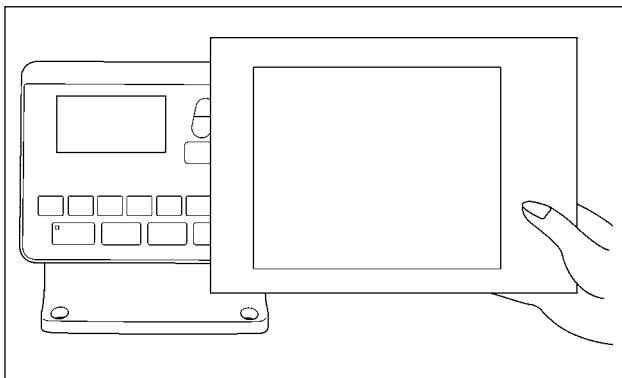

<Fig. 2>

② Precautions to be taken when handling NFC

- The position of the NFC antenna varies according to the tablet/smartphone used. Be sure to read the instruction manual of your device before using the NFC communication function.
- To use the NFC communication function, place the NFC communication function setting in "Enable" while referring to the instruction manual for your tablet/smartphone.

28. Setting the irregular work

In the case the sewing machine is not operated for a certain period of time, the work descriptions for that period can be input through the operation panel.

The data on the input work description can be collected and displayed by means of "JUKI Smart App".

Setting of irregular work should be carried by means of "JUKI Smart App". The set details can be checked on the operation panel.

1) Selecting the irregular work setting function

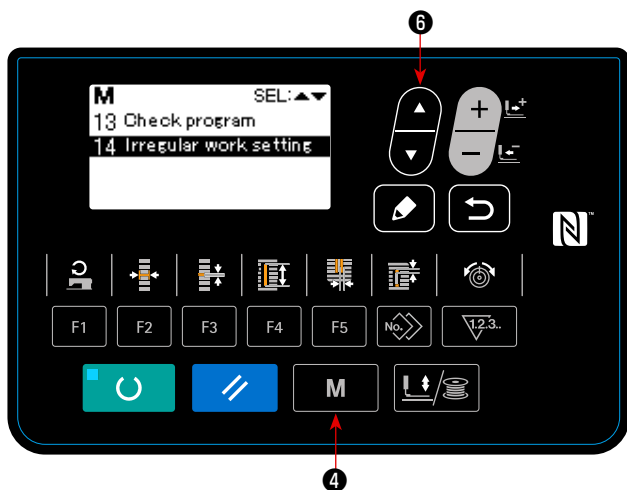

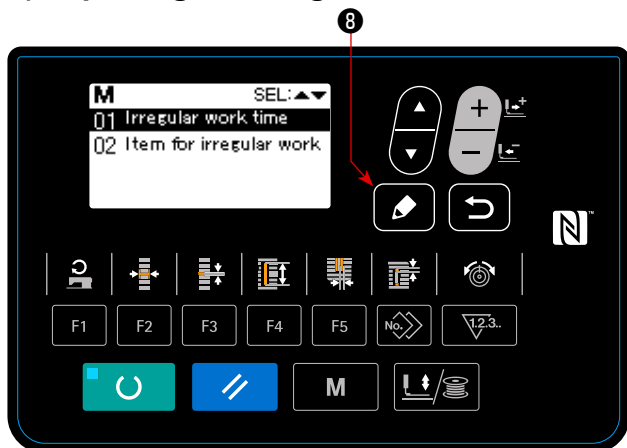

1. Keep MODE key **4** **M** held pressed for three seconds. Then, select "14. Setting the irregular work" with ITEM SELECT key **6** . The "irregular work setting screen" is displayed.

2) Inputting the irregular work



Enter the time during which the irregular work input screen is displayed in the case the sewing machine is not operated.

1. In the state where the "irregular work setting screen" is selected, press EDIT key **8** . Select the "irregular work time" and press EDIT key **8** . The "irregular work hours input screen" is displayed.

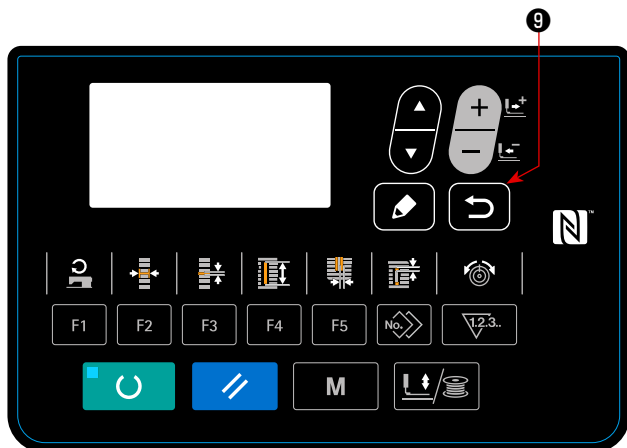



2. The preset time (in seconds) during which the irregular work input screen is displayed is displayed.
Range : 0 to 99 (Seconds)
Initial value : 0 (Function is turned)
Press RETURN key **9**  to display the "irregular work setting screen".

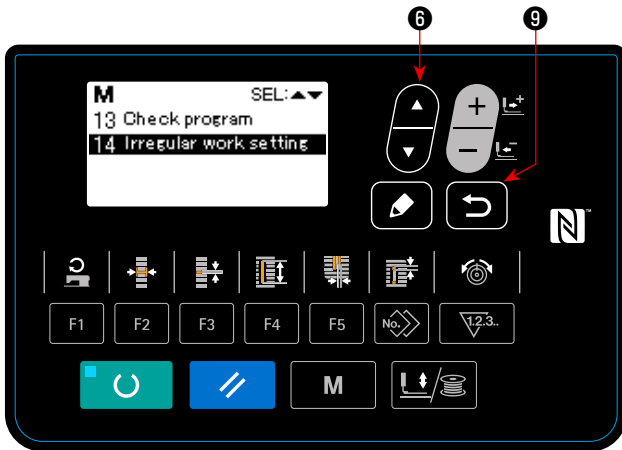

3) Displaying the "irregular work setting function"

Work items that are displayed on the irregular work input screen are displayed.
Carry out setting of work items by means of "JUKI Smart App".

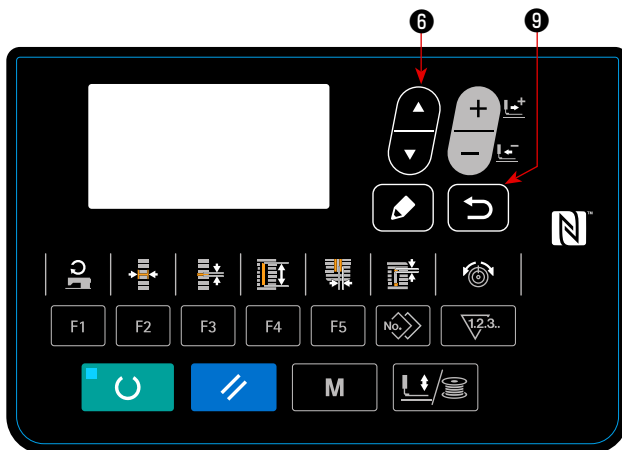

1. Press ITEM SELECT key **6**  on the "Irregular work items setting screen".
Select the "setting irregular work items" and press RETURN key **9**  to confirm the selection.
The "irregular work items setting screen" is displayed.



2. Work items can be checked by pressing ITEM SELECT key **6** .
Press RETURN key **9**  to display the "irregular work setting screen".

* The work items are as listed below.

No.	Work items	No.	Work items
01	Condition maintenance	08	Work meeting
02	Product arrangement	09	Transport
03	Thread change	10	Transfer
04	Record	11	Waiting for work
05	Failure	12	Fatigue
06	Judgment	13	Errand
07	Correction	14	Omission of duty

VI. MAINTENANCE

1. Adjusting the needle-to-hook relation



WARNING :

To protect against possible personal injury due to abrupt start of the machine, be sure to start the following work after turning the power off and ascertaining that the motor is at rest.

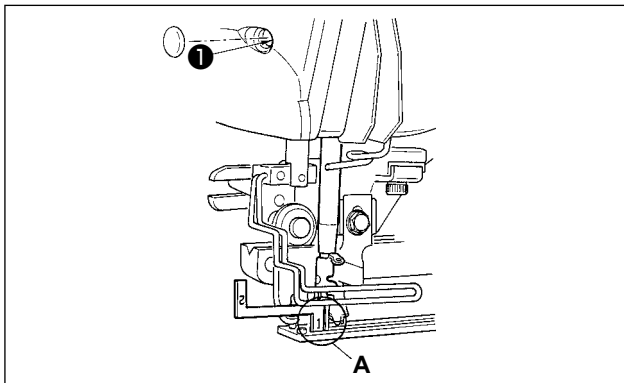

Adjust the needle-to-hook relation when the needle enters the center of the needle hole in the throat plate.

(1) Needle bar height

- 1) Bring down the needle bar to the lowest point.
- 2) Insert the part [1] **A** of timing gauge into the gap between the bottom end of needle bar and throat plate, where the bottom end of the needle bar touches the top of the part [1] **A** of the timing gauge.
- 3) Loosen needle bar connection screw **1**, and adjust the height of the needle bar.

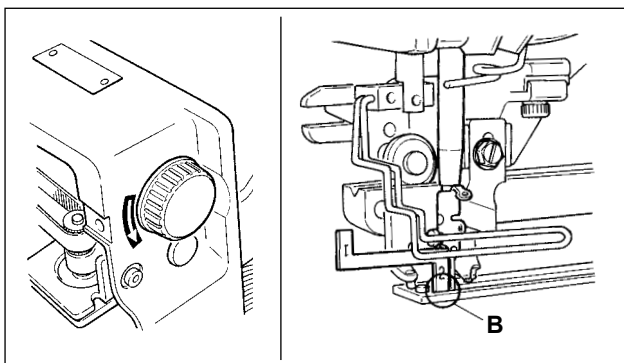

(2) Set the needle to hook relation in the following way :

- 1) Rotate the hand pulley in the correct direction until the needle starts to go up from its lowest point.
- 2) Insert the part [2] **B** of the timing gauge into the gap between the bottom end of the needle bar and the throat plate, where the bottom end of the needle bar touches the top of the part [2] **B** of the timing gauge.
- 3) Loosen setscrew **C** of the hook sleeve, and align blade point of the sewing hook with the center of needle hole. Make adjustment so that a clearance of approx. 0.05 mm is provided between the needle and the blade point of the hook.

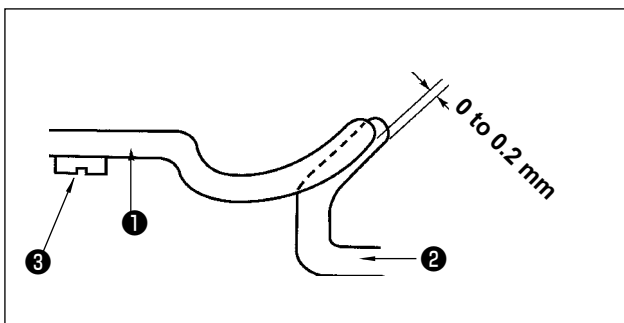
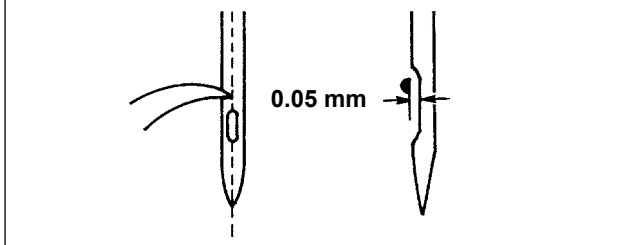
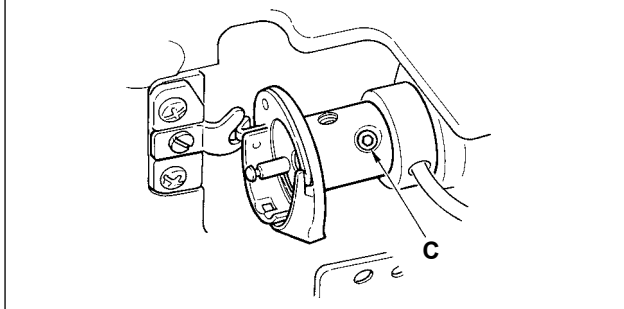

(3) Adjusting the bobbin case positioning stopper

Adjust with setscrew **3** so that the contact of the top end of bobbin case positioning stopper **1** and the end of inner hook **2** is 0 to 0.2 mm.

2. Adjusting the needle thread trimmer



WARNING :

To protect against possible personal injury due to abrupt start of the machine, be sure to start the following work after turning the power off and ascertaining that the motor is at rest.

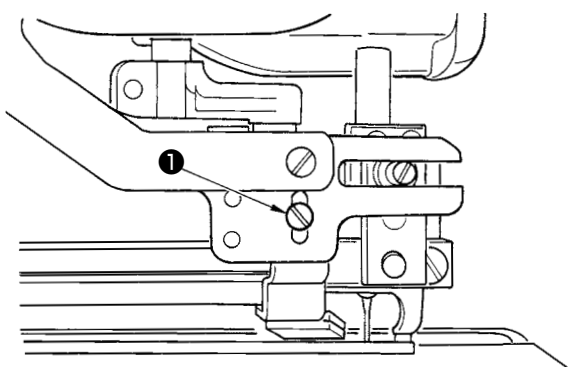
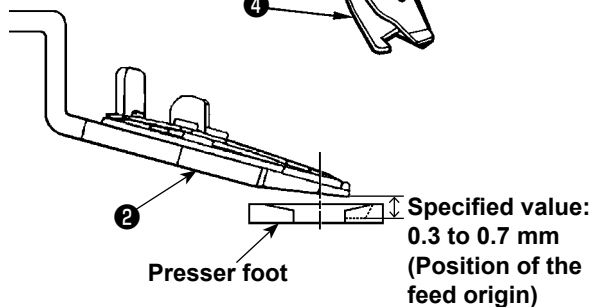
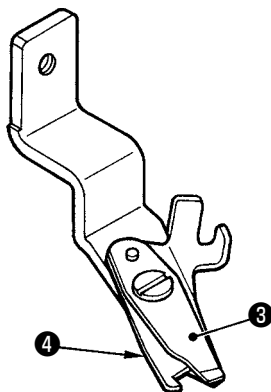
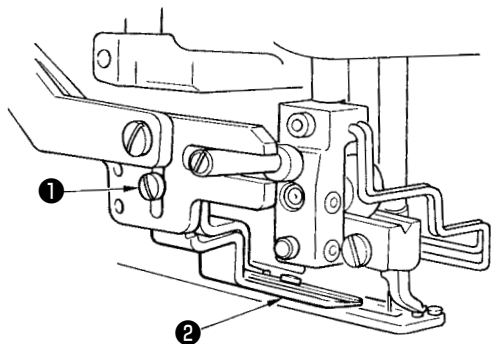

(1) Adjusting the thread grasping force of the needle thread trimmer

If the needle thread trimmer fails to provide consistent thread grasping force, the needle thread can slip off at the beginning of sewing.

- 1) If the thread grasping force of the needle thread trimmer has reduced, loosen setscrews ① and detach needle thread trimmer ②.
- 2) Slightly bend the top end of thread presser spring ③ so that it comes in contact with thread trimming blade of upper knife ④ over the length with no clearance and so that the needle thread trimmer securely holds the thread regardless of the position of the thread trimming blade at which the thread is trimmed.

If a malfunction occurs due to a change in sewing conditions, it is necessary to adjust the height of the needle thread trimmer within the range of specified value.

(2) Adjusting the height of the needle thread trimmer

The mounting height of the needle thread trimming scissors should be adjusted under the needle thread trimming adjustment mode (refer to "[V-14. How to edit/check the data other than sewing data](#)" p.50) (it should be adjusted while applying the standard pressure). Loosen needle thread trimming scissors mounting screw ① and adjust the height by moving the scissors up and down.

The clearance provided between the scissors and the work clamp foot differs with the position of the feed.

Position of the feed origin: 0.3 to 0.7 mm

When the feed is positioned at 180 mm, the clearance is 1.1 to 1.4 mm.

1. If the feed is moved forward and the height of the scissors is adjusted to an excessively low position, the work clamp foot will interfere with the needle thread trimming scissors when lifting and lowering the work clamp foot.
2. When the needle thread trimmer is replaced, check to make sure that the thread trimmer normally operates at the front, middle and rear sections of the presser foot under the needle thread trimmer adjustment mode.



3. Adjusting the presser bar pressure



WARNING :

To protect against possible personal injury due to abrupt start of the machine, be sure to start the following work after turning the power off and ascertaining that the motor is at rest.

The presser bar pressure should be set on a pattern-by-pattern basis.

1) Set the mode to the input mode.

Under the input mode where SET READY LED ⑳ goes out, change of the pattern is enabled.

If the current mode is the sewing mode, press

READY key ②  to change over the mode to the input mode.

2) Invoke "S090 Presser bar pressure"

Press EDIT key ⑧ . Then, press ITEM SE-

LECT key ⑥  to select presser bar pressure A.

Increasing the set value of S090 will increase the presser bar pressure to help prevent puckering.

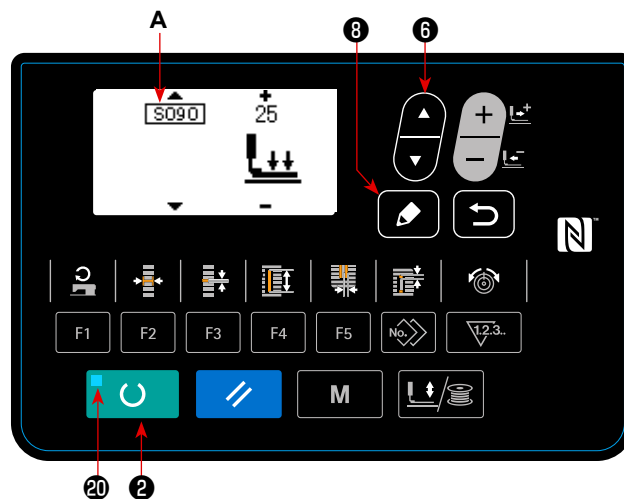

4. Adjustment of the bobbin presser unit



WARNING :

To protect against possible personal injury due to abrupt start of the machine, be sure to start the following work after turning the power off and ascertaining that the motor is at rest.

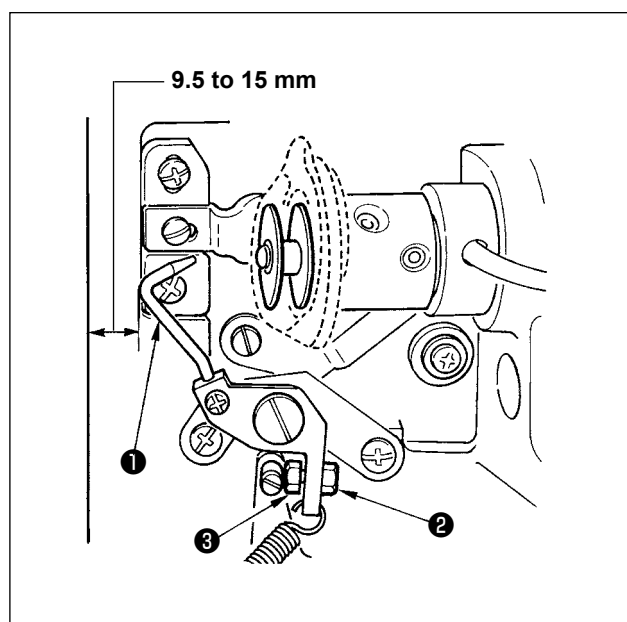

Loosen nut ① and adjust the position with stopper spring ② so that the distance from the front end of machine bed to bobbin presser ③ is 9.5 to 15 mm when the sewing machine stops. Then tighten nut ②.

5. Thread tension

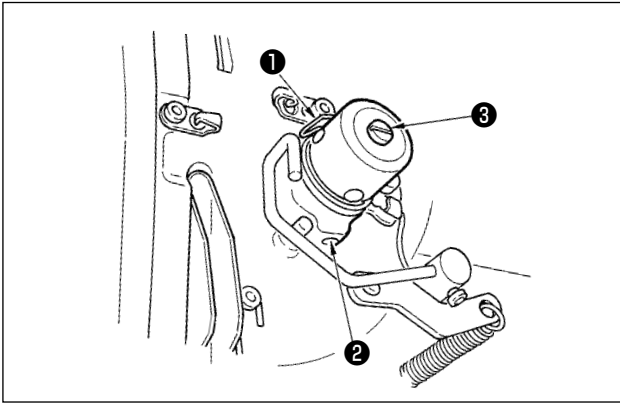

(1) Thread take-up spring (purl stitch)

- 1) The thread take-up amount of thread take-up spring ① is 8 to 10 mm, and the appropriate pressure at the start is approximately 0.06 to 0.1N.
- 2) To change the stroke of the thread take-up spring, loosen screw ②, insert a thin screwdriver into the slot of thread tension post ③, and turn it.
- 3) To change the pressure of the thread take-up spring, insert a thin screwdriver into the slot of thread tension post ③ while screw ② is tightened, and turn it. Turning it clockwise will increase the pressure of the thread take-up spring. Turning it counterclockwise will decrease the pressure.

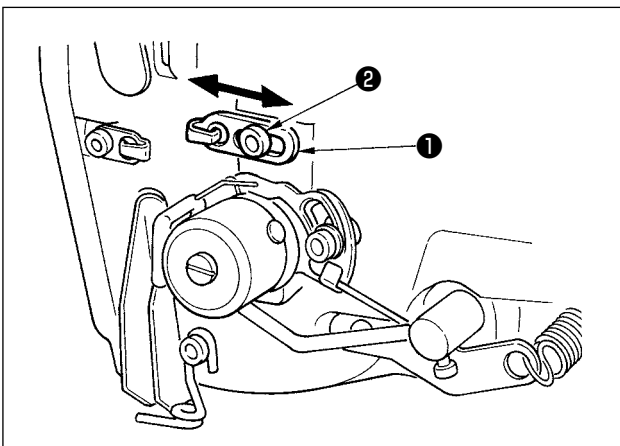

(2) Adjusting the thread take-up amount of the thread take-up lever

The thread take-up amount of the thread take-up lever should be adjusted in accordance with the thickness of the sewing products so as to obtain well-tightened stitches.

- a. For heavy-weight materials, loosen setscrew ② in thread guide ①, and move the thread guide to the left. The thread take-up amount of the thread take-up lever will be increased.
- b. For light-weight materials, move thread guide ① to the right. The thread take-up amount of the thread take-up lever will be reduced.

6. Replacing the fuse



WARNING :

1. To avoid electrical shock hazards, turn OFF the power and open the control box cover after about five minutes have passed.
2. Open the control box cover after turning OFF the power without fail. Then, replace with a new fuse with the specified capacity.

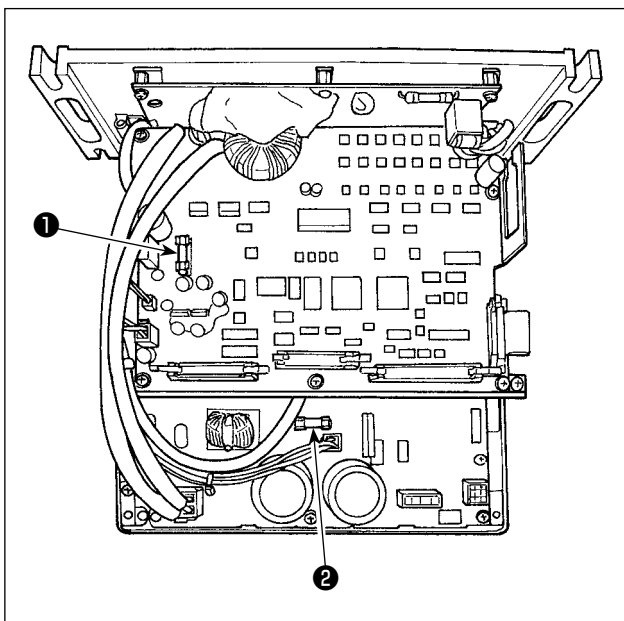

- 1) Turn OFF the power with the power switch after confirming that the sewing machine has stopped.
- 2) Draw the power cord from the power receptacle after confirming that the power switch is turned OFF.
Then wait for more than 5 minutes.
- 3) Remove four screws fixing the rear cover of the control box. Then slowly open the rear cover.
- 4) Grasp the glass section of the fuse to be replaced and remove it.
- 5) Use the fuse with the specified capacity.

❶ F1 fuse 5A
For DC+60V power protection
Fuse for power protection of pulse motor and AT solenoid

❷ F2 fuse 2A
For DC+24V power protection
Fuse for power protection such as solenoid valves and sensors

7. Adjusting the parallel lifting of the presser foot



WARNING :

To protect against possible personal injury due to abrupt start of the machine, be sure to start the following work after turning the power off and ascertaining that the motor is at rest.

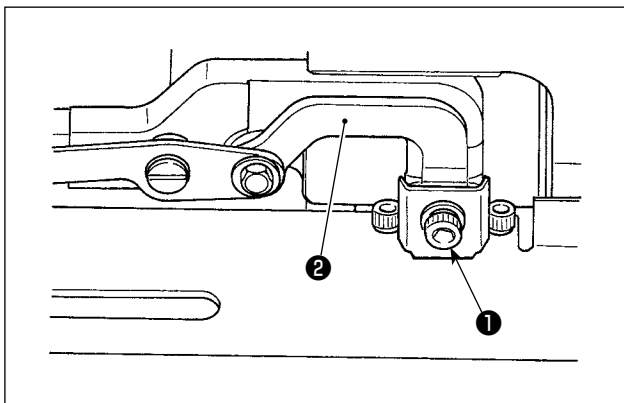

- 1) Loosen setscrew ❶ .
- 2) Turn link mounting base ❷ to adjust so that the presser foot goes up in parallel to the base.
- 3) Securely tighten setscrew ❶ .



The link mounting base is fixed with one setscrew only. Firmly tighten the setscrew (with a tightening torque of 3.5 N·m) after the adjustment.

8. Accessory adhesive tape

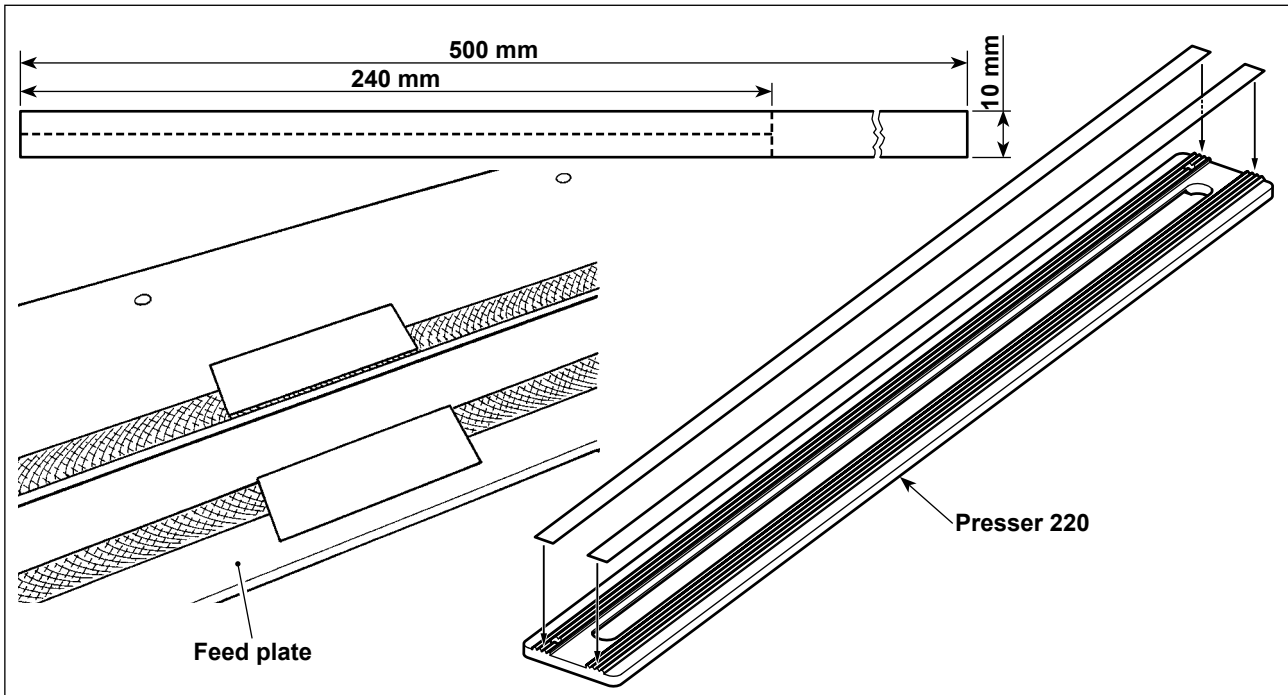

Non-slip adhesive tape (white)

In the case of sewing a light-weight floppy material, cut the accessory non-slip adhesive tape into the size of 240 mm × 5 mm as shown in the figure. Stick it onto the underside (knurled side) of the presser foot to prevent the material from flopping.

In the case the material is likely to flop around the center (near the second buttonhole) of the presser foot, in particular, it is recommended to stick the non-slip adhesive tape onto the feed plate to effectively prevent the material from flopping.



1. Before sticking the non-slip adhesive tape, wipe clean the underside of the presser foot (knurled side) and the feed plate surface onto which the non-slip adhesive tape is to be stuck.
2. Stick the non-slip adhesive tape while carefully preventing it from protruding outside the front/rear and right/left edges of the presser foot and outside the slot in the feed plate. If the non-slip adhesive tape protrudes from those sections, the tape is likely to peel off easily.

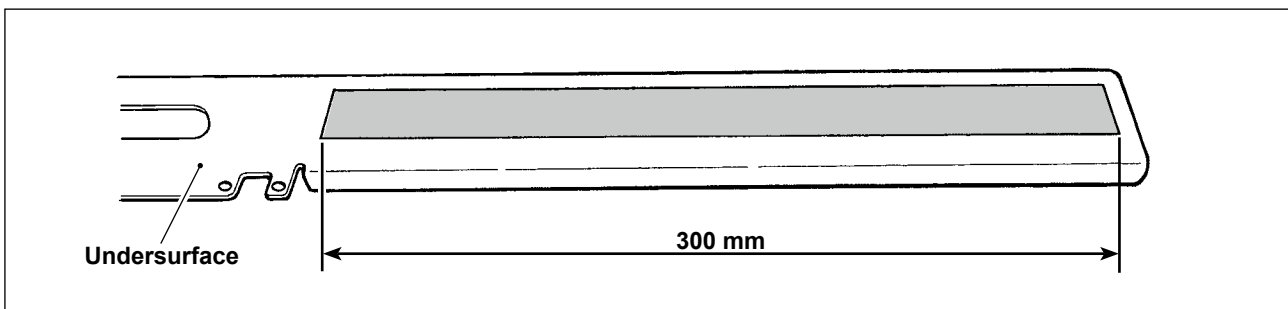

Surface smoothness increasing adhesive tape (black)

This adhesive tape is intended to be applied to the underside of the feed plate to help increase its surface smoothness. If the adhesive tape has worn out or come away, remove the defective tape and apply the accessory adhesive tape to the feed plate.



1. In the case the adhesive tape is not applied to the underside of the feed plate, chattering noise can be produced since the underside of the feed plate and the bed are directly rubbing against each other.
2. Periodically remove the feed plate to wipe it clean of oil stains and grime.

9. Auxiliary sheet

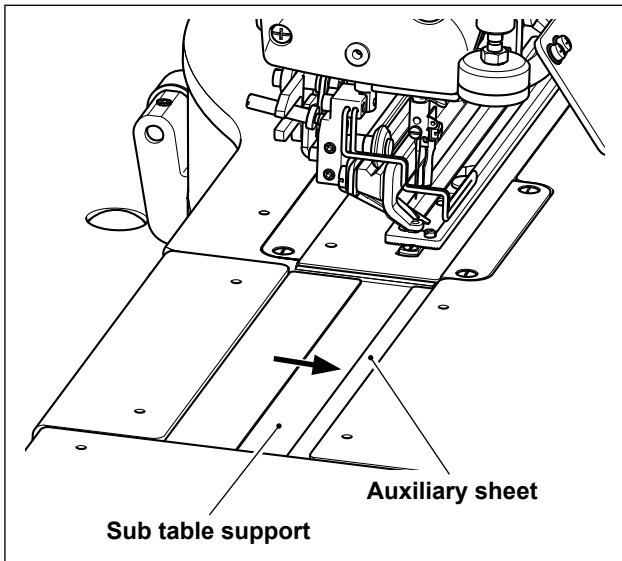

Auxiliary sheet (transparent)

Attach double-sided adhesive tape on the accessory auxiliary sheet. Then, stick the auxiliary sheet on the sub table support.

Stick it against the right edge (in the direction of the arrow) of the sub table support as far as possible as shown in the figure.

1. Before attaching the auxiliary sheet to the sub table support, prepare double-sided adhesive tape.



2. Before attaching the auxiliary sheet to the sub table support, wipe clean the sub table support surface onto which the auxiliary sheet is to be stuck.

10. Material-feed auxiliary sheet (optional)

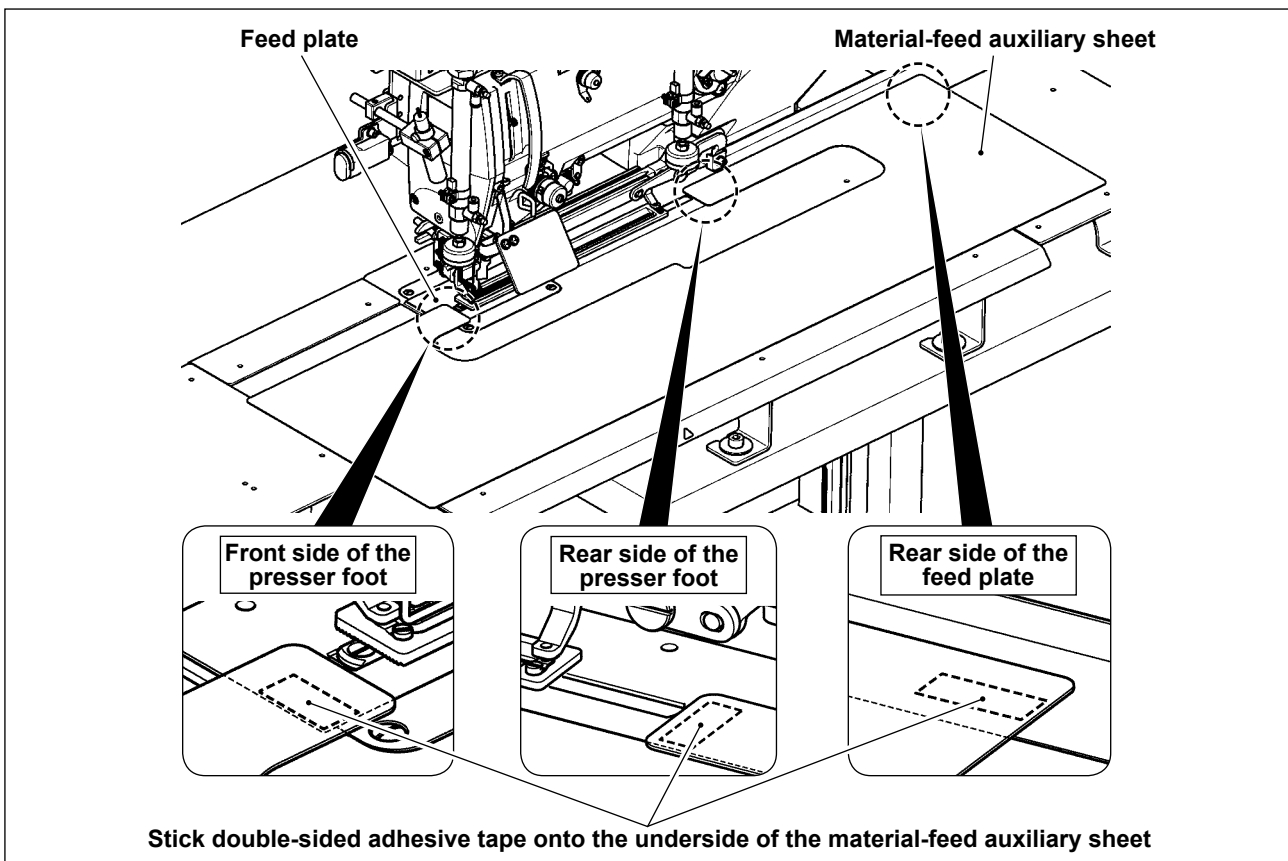

Stick double-sided adhesive tape onto the underside of the material-feed auxiliary sheet

Material-feed auxiliary sheet (40162614)

Uneven feed of the material can be prevented by securely attaching the optional material-feed auxiliary sheet to the feed plate with double-sided adhesive tape.

When the optional material-feed auxiliary sheet is attached to the feed plate, it is possible to feed the entire front body at a time. This sheet is useful when sewing a hard-to-feed material or the material which is likely to be fed unevenly.

Stick double-sided adhesive tape onto the underside of the material feed auxiliary sheet. Then, fix the material-feed auxiliary sheet on the feed plate.

* Double-sided adhesive tape is not supplied with the sewing machine. It should be prepared separately.

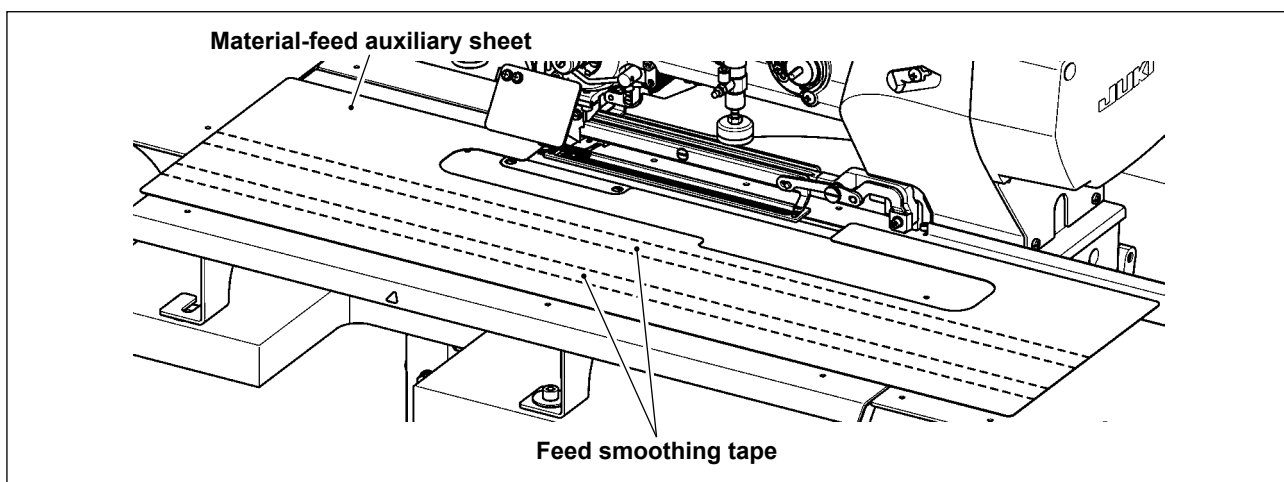
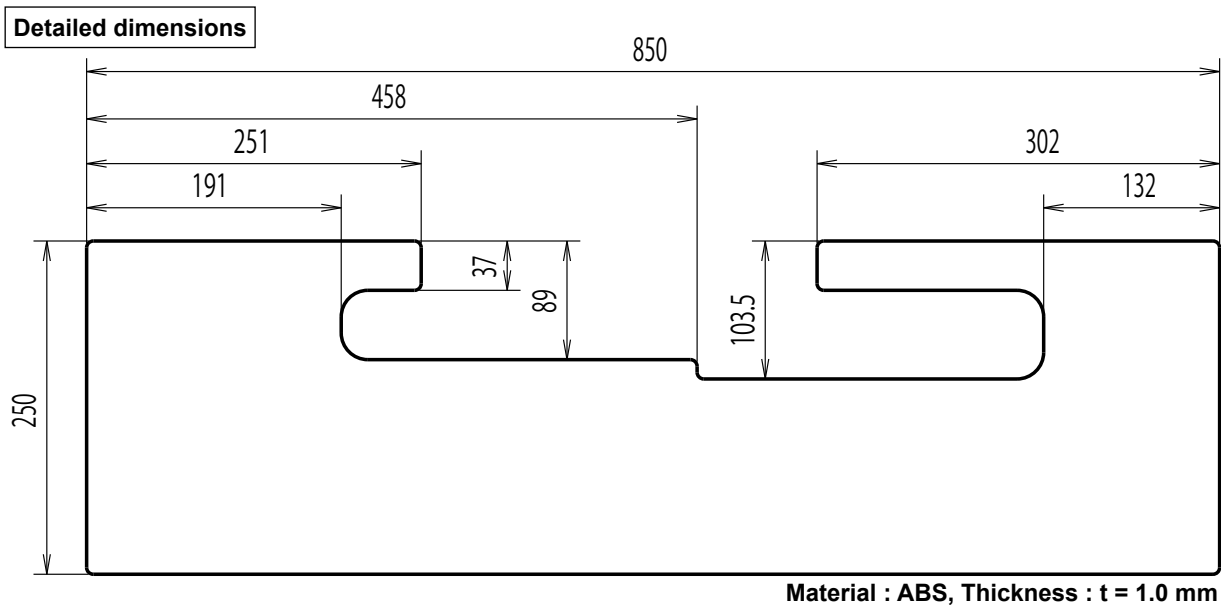

The material-feed auxiliary sheet is allowed to feed the material more smoothly by attaching the feed smoothing tape (40044824, 1 pc.) supplied with the sewing machine to the underside of the material-feed auxiliary sheet.

* The figure shows an example where two pieces of the feed smoothing tape are used. Purchase more pieces of the feed smoothing sheet if needed.

VII. GAUGE COMPONENTS

1. Cloth cutting knife

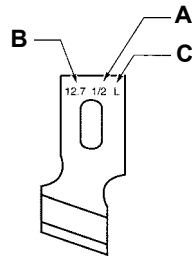

A Knife size (inch)	B Knife size (mm)	C Mark	D Part No.
1/4	6.4	F	B2702047F00
3/8	9.5	K	B2702047K00A
7/16	11.1	I	B2702047I00
1/2	12.7	L	B2702047L00A
9/16	14.3	V	B2702047V00
5/8	15.9	M	B2702047M00A
11/16	17.5	A	B2702047A00
3/4	19.1	N	B2702047N00
7/8	22.2	P	B2702047P00
1	25.4	Q	B2702047Q00A

VIII. ERROR CODE LIST

1. How to operate the sewing machine in the case an error is displayed

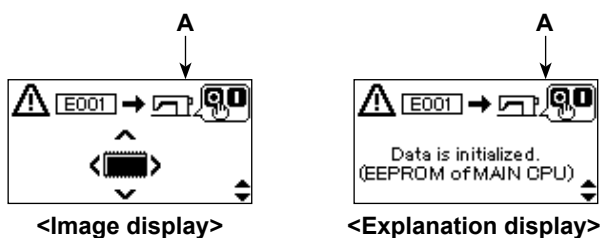



















1) Checking the error content



















Press item select key  to change over the display between the image display and the explanation display.











2) Recovering from the error







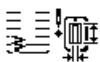









The sewing machine can be recovered from the error by carrying out the operation A (turning the power OFF or operating the operation panel) according to the error content.

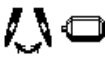
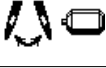











Display	How to recover
	Turn OFF the power.
	Press the key which is displayed.

Error code		Description	How to recover	Place of recovery
E001		Contact of initialization of EEP-ROM of MAIN CONTROL p.c.b. When data is not written in EEP-ROM or data is broken, initialization of the data is automatically informed.	Turn OFF the power.	
E007		Main shaft motor-lock When large needle resistance sewing product is sewn	Turn OFF the power.	
E011		External media not inserted External media is not inserted.	Possible to recover by reset.	
E012		Read error Data read from external media cannot be performed.	Possible to recover by reset.	Previous screen
E013		Write error Data write from external media cannot be performed.	Possible to recover by reset.	Previous screen
E014		Write protect External media is in the write prohibition state	Possible to recover by reset.	Previous screen
E015		Format error Formatting of external media cannot be performed.	Possible to recover by reset.	Previous screen
E016		External media capacity over Capacity of external media is short.	Possible to recover by reset.	Previous screen
E017		EEP-ROM capacity over Capacity of EEP-ROM is short.	Possible to recover by reset.	Previous screen
E018	TYPE 	Type of EEP-ROM is different When the mounted EEP-ROM is different in type.	Turn OFF the power.	Previous screen
E019		File size over File size to be read in is too large.	Possible to recover by reset.	Previous screen
E022		File No. error There is no designated file in the server or external media.	Possible to recover by reset.	Previous screen
E023		Detection of step-out of presser lifting motor When step-out of motor is detected at the time when presser lifting motor passes origin sensor or starts operation.	Possible to recover by reset.	Standard screen
E024		Pattern data size over When sewing cannot be performed since total size of continuous stitching data or size of downloaded data is too large.	Possible to recover by reset.	Standard screen
E025		Detection of step-out of needle thread trimmer motor When step-out of motor is detected at the time when needle thread trimmer motor passes origin sensor or starts operation.	Possible to recover by reset.	Standard screen
E026		Detection of step-out of bobbin thread trimmer motor When step-out of motor is detected at the time when bobbin thread trimmer motor passes origin sensor or starts operation.	Possible to recover by reset.	Standard screen
E030		Needle bar upper position failure When needle does not stop at UP position even with needle UP operation at the time of starting sewing machine.	Possible to recover by reset.	Standard screen

Error code		Description	How to recover	Place of recovery
E032		File interchangeability error In the case of attempting to read such data that cannot be read by the sewing machine head model/software version.	Possible to recover by reset.	Previous screen
E042	-	Operation error Operation of sewing data cannot be performed.	Possible to recover by reset.	Data input screen
E043		Enlargement error Stitching pitch exceeds 5 mm.	Possible to recover by reset.	Data input screen
E050		Stop switch When stop switch is pressed during machine running.	Possible to recover by reset.	Step screen
E052		Thread breakage detection error When thread breakage has occurred during machine running.	Possible to recover by reset.	Step screen
E061		Memory switch data error When memory switch data is broken or revision is old.	Turn OFF the power.	
E062		Sewing data error When sewing data is broken or revision is old.	Turn OFF the power.	
E063		Machine head identification error In the case the machine head model name does not match the main PCB model name.	Press the reset key.	Machine head selection screen
E081		Needle rocking motor out-of-step detection error In the case the out-of-step of the X needle-rocking motor is detected.	Turn OFF the power.	
E082		Feed motor out-of-step detection error In the case the out-of-step of the Y feed motor is detected.	Turn OFF the power.	
E083		Presser foot position error In the case the presser foot height is excessively high at the time of starting sewing Adjust K023.	Turn OFF the power.	
E098		Error caused by insufficient number of stitches required for thread trimming	Possible to re-enter after pressing reset key.	Standard screen
E099		Interference of knife lowering command with thread trimming motion When inserting position of knife command is improper and knife command interferes with thread trimming motion in case of motion by data from external input device.	Possible to recover by reset.	Standard screen
E204		Warning against connection of USB thumb drive during sewing In the case sewing is carried out continuously by 10 times with the USB thumb drive connected (if the sewing machine is performing a continuous sewing pattern when continuous 10-times sewing is finished, the warning is given upon completion of sewing of the continuous sewing pattern)	Sewing can be re-started after re-setting the warning	Standard screen
E302		Machine head tilt or hook cover opening In the case the machine head tilt detection signal is ON	Possible to recover by reset.	Previous screen
E303		Z phase sensor error of main shaft motor Z phase sensor of sewing machine motorencoder is abnormal.	Turn OFF the power.	
E304		Cloth cutting knife sensor error When sensor is not OFF while knife is lowered.	Turn OFF the power.	
E398		Optional-cylinder lift detection failure Lift of the optional cylinder cannot be detected, or the optional cylinder is not installed though [K013] "Optional cylinder installation selection" is set to ON.	Possible to recover by reset.	Standard screen
E399		Optional-cylinder lowering detection failure Lowering of the optional cylinder cannot be detected, or the optional cylinder is not installed though [K013] "Optional cylinder installation selection" is set to ON.	Possible to recover by reset.	Standard screen
E402		Individual sewing data deletion prohibition error In the case of attempting to delete the individual sewing data which has been registered in cycle/continuous sewing data.	Possible to recover by reset.	Previous screen



Error code		Description	How to recover	Place of recovery
E407		Continuous sewing data deletion prohibition error In the case of attempting to delete the continuous sewing data which has been registered in cycle data.	Possible to recover by reset.	Previous screen
E430	* Count-up screen display (see page 37)	Count-up error	Possible to re-sewing after pressing reset key.	Sewing screen
E485		Number of times of basting unsetting error In the case the number of times of basting is not set (OFF) for "Basting+ Cloth cutting knife shape".	Possible to recover by reset.	(During individual sewing/cycle sewing) Sewing data edit screen [S034] Basting stitch (OFF/Number of times) (During continuous sewing) Standard screen
E486		Eyelet knife length error Eyelet knife length is too short to form the shape in case of eyelet shape.	Possible to re-enter after pressing reset key.	(During individual sewing/cycle sewing) Sewing data edit screen [S017] Eyelet knife length (During continuous sewing) Standard screen
E487		Eyelet shape length error Eyelet shape length is too short to form the shape in case of eyelet shape.	Possible to re-enter after pressing reset key.	(During individual sewing/cycle sewing) Sewing data edit screen [S014] Eyelet shape length (During continuous sewing) Standard screen
E488		Taper bar-tacking compensation error When bar-tacking length is too short to form the shape in case of taper bar-tacking shape.	Possible to re-enter after pressing reset key.	(During individual sewing/cycle sewing) Sewing data edit screen [S008] 2nd bar-tacking length (During continuous sewing) Standard screen
E489		Knife size error (at the time of plural motions of knife) When knife size is larger than cloth cutting knife size.	Possible to re-enter after pressing reset key.	(During individual sewing/cycle sewing) Sewing data edit screen [S002] Cloth cut length (During continuous sewing) Standard screen
E492		Presser size over of basting When stitching data of basting exceeds presser size.	Possible to re-enter after pressing reset key.	(During individual sewing/cycle sewing) Sewing data edit screen [S040] Basting needle entry compensation (During continuous sewing) Standard screen
E493		Presser size over of tie stitching at sewing end When stitching data of tie stitching at sewing end exceeds presser size.	Possible to re-enter after pressing reset key.	(During individual sewing/cycle sewing) Sewing data edit screen [S067] Tie stitching at sewing end width (During continuous sewing) Standard screen
E494		Presser size over of tie stitching at sewing start When stitching data of tie stitching at sewing start exceeds presser size.	Possible to re-enter after pressing reset key.	(During individual sewing/cycle sewing) Sewing data edit screen [S064] Tie stitching at sewing start width (During continuous sewing) Standard screen
E495		Presser size error (Width direction : right only) When stitching data exceeds the size of right only of width direction of presser.	Possible to re-enter after pressing reset key.	(During individual sewing/cycle sewing) Sewing data edit screen [S003] Knife groove width, right or [S006] Ratio of right and left shapes (During continuous sewing) Standard screen
E496		Presser size error (Width direction : left only) When stitching data exceeds the size of left only of width direction of presser.	Possible to re-enter after pressing reset key.	(During individual sewing/cycle sewing) Sewing data edit screen [S004] Knife groove width, left or [S006] Ratio of right and left shapes (During continuous sewing) Standard screen

Error code		Description	How to recover	Place of recovery
E497		Presser size error (Length direction : front) When stitching data exceeds the size of front of length direction of presser.	Possible to re-enter after pressing reset key.	Standard screen
E498		Presser size error (Width direction : right and left) When stitching data exceeds the size of both right and left of width direction of presser.	Possible to re-enter after pressing reset key.	(During individual sewing/cycle sewing) Sewing data edit screen [S005] Overedging width, left (During continuous sewing) Standard screen
E499		Presser size error (Length direction : rear) When stitching data exceeds the size of rear of length direction of presser. Or, a sewing pattern which includes a command to operate the scissors is used in the area where the operation of the scissors is prohibited (within 14.5 mm from the far end of the prohibition area).	Possible to re-enter after pressing reset key.	(During individual sewing/cycle sewing) Sewing data edit screen [S002] Cloth cut length (During continuous sewing) Standard screen
E703		Panel is connected to the machine other than supposed. (Machine type error) When machine type code of system is improper in case of initial communication.	Software can be rewritten after pressing the mode key.	Communication screen
E704		Nonagreement of system version When version of system software is improper in case of initial communication.	Software can be rewritten after pressing the mode key.	Communication screen
E730		Main shaft motor encoder defectiveness or phase-out When encoder of sewing machine motor is abnormal.	Turn OFF the power.	
E731		Main motor hole sensor defectiveness or position sensor defectiveness When hole sensor or position sensor of sewing machine motor is defective.	Turn OFF the power.	
E733		Reverse rotation of main shaft motor When sewing machine motor rotates in reverse direction.	Turn OFF the power.	
E798		Needle throwing operation failure In the case the needle throwing operation does not match the number of stitches	Turn OFF the power.	
E799		Needle throwing operation failure In the case the needle throwing operation does not match the number of stitches	Turn OFF the power.	
E801		Phase-lack of power When phase-lack of input power occurs.	Turn OFF the power.	
E802		Power instantaneous cut detection When input power is instantaneously OFF.	Turn OFF the power.	
E811		Overvoltage In the case the input power source voltage/current is equal to or more than the specified value	Turn OFF the power.	
E813		Low voltage In the case the input power source voltage/current is equal to or less than the specified value	Turn OFF the power.	
E820		24 VDC fuse has blown out When the SDC fuse has blown out.	Turn OFF the power.	
E901		Abnormality of main shaft motor IPM When IPM of servo control p.c.b. is abnormal.	Turn OFF the power.	
E903		Abnormality of stepping motor power In the case the stepping motor power of the servo-control PCB is out of the range of the specified values	Turn OFF the power.	
E904		Abnormality of solenoid power In the case the solenoid power of the servo-control PCB is out of the range of the specified values	Turn OFF the power.	

Error code		Description	How to recover	Place of recovery
E905		Abnormality of temperature of heat sink for servo control p.c.b. When temperature of heat sink of servo control p.c.b. is 85°C or more.	Turn OFF the power.	
E906		Main PCB heat sink temperature fault In the case the temperature of the heat sink of the main PCB increases	Turn OFF the power.	
E907		Needle rocking motor origin retrieval error When origin sensor signal is not inputted at the time of origin retrieval motion.	Turn OFF the power.	
E908		Y feed motor origin retrieval error When origin sensor signal is not inputted at the time of origin retrieval motion.	Turn OFF the power.	
E909		Needle thread trimmer motor origin retrieval error When origin sensor signal is not inputted at the time of origin retrieval motion.	Turn OFF the power.	
E910		Presser motor origin retrieval error When origin sensor signal is not inputted at the time of origin retrieval motion.	Turn OFF the power.	
E911		Bobbin thread trimmer motor origin retrieval error When origin sensor signal is not inputted at the time of origin retrieval motion.	Turn OFF the power.	
E912	-	Sewing motor speed detection error In the case the sewing machine motor malfunctions	Turn OFF the power.	
E915		Abnormality of communication between operation panel and main CPU When abnormality occurs in communication.	Turn OFF the power.	
E916		Abnormality of communication between main CPU and main shaft CPU When abnormality occurs in communication.	Turn OFF the power.	
E918		Abnormality of temperature of heat sink for main control p.c.b. When temperature of heat sink of main control p.c.b. is 85°C or more.	Turn OFF the power.	
E943		Defectiveness of EEPROM of main control p.c.b. When data writing to EEPROM is not performed.	Turn OFF the power.	
E946		Defectiveness of writing to EEPROM of head relay p.c.b. When data writing to EEPROM is not performed.	Turn OFF the power.	
E998		Presser deviation error In the case the presser foot fails to go up when the pedal is released or when the sewing is finished. Turn the power OFF. Check whether the work clamp can be lifted/lowered manually. During the aforementioned check, be careful about the needle and the knife.	Turn OFF the power.	
E999		When cloth cutting knife does not return <ul style="list-style-type: none"> When cloth cutting knife does not return after the lapse of predetermined time. When sensor is not turned ON while cloth cutting knife is raising (at the time of waiting). 	Turn OFF the power.	

2. Operation procedure to be followed when a message is displayed

Operate the sewing machine in the same manner as the error is displayed.

Message code		Message content	How to recover	Return to
M582		Exit from the copy screen without copying the pattern.	Press the return key.	Standard screen
M584		Exit from the copy screen without copying the cycle pattern.	Press the return key.	Standard screen
M585		Exit from the copy screen without copying the continuous stitching pattern.	Press the return key.	Standard screen
M610	Sewing machine model name check screen is displayed (Refer to 28.)	Initialize the data according to the model name of the main PCB.	(Refer to 28.)	(Refer to 28.)

IX. TROUBLES AND CORRECTIVE MEASURES

Troubles	Causes	Corrective measures	Page
1. Needle thread break-age	1. Thread tension at parallel section is too high.	○ Decrease the thread tension at parallel section.	34
	2. Pressure or stroke of thread take-up spring is too large.	○ Decrease the tension of thread take-up spring or decrease its stroke.	80
	3. There is a burr or scratch on the blade point of hook.	○ Buff the blade point of hook. Or, replace the hook.	–
	4. Hook timing is not proper.	○ Adjust again the hook timing with timing gauge.	77
	5. There is a scratch on the thread path.	○ Polish the thread path with sand paper and buff it.	–
	6. Attaching needle is wrong.	○ Adjust again the direction, height, etc.	22
	7. Needle is too thin.	○ Replace the needle with a thicker one.	–
	8. Needle tip is damaged.	○ Replace the needle.	–
	9. Thread breaks when it is bent.	○ Do not pass the thread through the thread guide pin.	20
	10. The origin of the presser foot is out of correct position.	○ Re-adjust the origin.	–
2. Needle thread slips off.	1. Needle thread trimmer opens too early.	○ Delay the opening timing of the needle thread trimmer.	78
	2. Whip stitching is not formed at the start of sewing.(Tension at the start of sewing is too high.)	○ Decrease tension at the start of sewing.	46
	3. Threading needle thread is wrong.	○ Thread properly again.	23
	4. Speed at the start of sewing is too fast.	○ Set the soft-start function.	64
3. Wobbling at parallel section	1. Thread tension at parallel section is too low.	○ Increase the thread tension at parallel section.	34
	2. Bobbin thread tension is too high.	○ Decrease bobbin thread tension. (Purl stitching : 0.05 to 0.1N)	24
	3. Pre-tension is too low.	○ Increase pre-tension.	–
4. Wobbling at the start of sewing	1. Thread tension at parallel section is too low.	○ Increase the thread tension at parallel section.	34
	2. Position of needle thread trimmer is too high.	○ Lower the needle thread trimmer to such an extent that it does not come in contact with the presser.	78
	3. Stroke of thread take-up spring is too large.	○ Decrease the stroke of thread take-up spring.	80
5. Needle thread appears on the wrong side of material at bar-tacking section in dumping condition.	1. Bar-tacking thread tension is too low.	○ Increase the bar-tacking thread tension.	34
	2. Bobbin thread tension is too high.	○ Decrease the bobbin thread tension. (0.05 to 0.1N)	24
	3. Number of stitches of radial shape is too many.	○ Decrease the number of stitches.	44
	4. Tension at the end of sewing is too low.	○ Increase tension at the end of sewing.	64
6. Stitches float.	1. Bobbin thread tension is too low.	○ Increase the bobbin thread tension.	24
	2. Bobbin thread comes off bobbin case.	○ Perform proper threading the bobbin case. ○ Take care that the winding amount of bobbin thread is not excessive.	23 36
7. Stitch skipping	1. Button hole is small in terms of the size of presser.	○ Replace the presser with a smaller one.	–
	2. Material flops because of light-weight.	○ Delay the hook-to-needle timing. (Lower the needle bar by 0.5 mm.)	77
	3. Attaching needle is wrong.	○ Adjust again the direction, height, etc.	22
	4. Needle is bent.	○ Replace the needle.	–
	5. There is a burr or scratch on the blade point of hook.	○ Buff the blade top of hook. Or, replace the hook.	–
8. Thread frays.	1. Number of stitches of tie stitching is too small.	○ Increase the number of stitches of tie stitching at the end of sewing.	47
	2. Width of tie stitching is too wide.	○ Narrow the width of tie stitching at the end of sewing.	47

Troubles	Causes	Corrective measures	Page
9. Length of needle thread remaining at the end of sewing is too long.	1. Width of tie stitching is too narrow.	<ul style="list-style-type: none"> ○ Widen the width of tie stitching at the end of sewing. ○ Increase tension at the end of sewing. 	47
	2. Tension of tie stitching is too low.		64
10. Needle thread breaks at the start of sewing, or the wrong side of seam is dirty.	1. Tension at the start of sewing is too low.	<ul style="list-style-type: none"> ○ Increase tension at the start of sewing. 	46
11. Knife drops even when needle thread is cut.	1. Check whether the thread breakage detector plate is properly adjusted.	<ul style="list-style-type: none"> ○ Adjust the detector plate. (Refer to the Engineer's Manual.) 	–
12. Needle breaks.	1. Check whether needle is bent.	<ul style="list-style-type: none"> ○ Replace the needle. ○ Adjust the needle-to-hook timing. 	22
	2. Check whether needle comes in contact with the blade point of hook.		77
	3. Check whether needle thread trimmer comes in contact with needle when it opens.	<ul style="list-style-type: none"> ○ Adjust the installing position of needle thread trimmer. ○ Re-adjust the installing position of throat plate base. 	78
	4. Check whether needle comes in the center of the needle hole of throat plate.		–
	5. Needle stop position is too low and needle comes in contact with needle thread trimmer when it closes.		
13. Knife drops plural times.	1. Check whether the cloth cutting knife dropping is set to plural dropping.	<ul style="list-style-type: none"> ○ Release the plural time setting. 	64

X. DRAWING OF THE TABLE

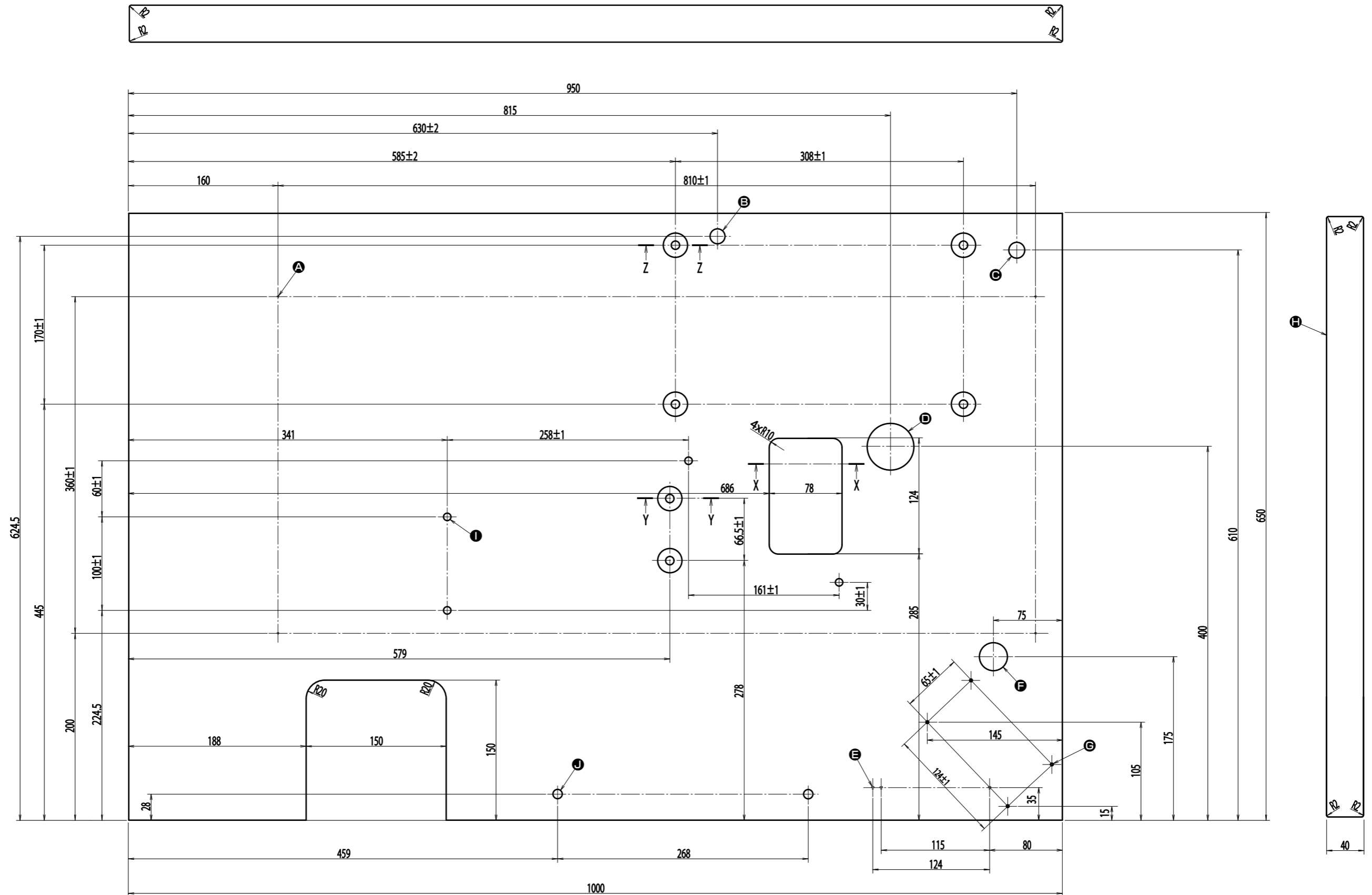

- Ⓐ 4×Table stand installing hole
- Ⓑ 16 drilling depth 30
- Ⓒ Machine head support rod mounting hole
- Ⓓ 17 drilled hole
- Ⓔ Thread stand device mounting hole
- Ⓕ 50 drilled hole
- Ⓖ Hole for cable
- Ⓗ 3×Main switch installing hole
- Ⓘ 30 drilled hole
- Ⓚ Hole for panel cord
- Ⓛ 4×Panel installing position
- Ⓜ Top surface
- Ⓨ 4×8 drilled hole
- Ⓩ Sewing machine mounting hole
- ⓐ 2×10 drilled hole
- ⓑ Sub table A mounting hole

Y-Y (2 locations)

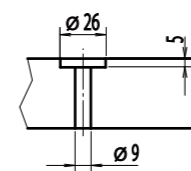

Z-Z (4 locations)

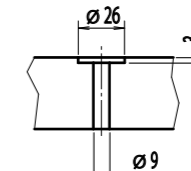

X-X

